

**RCM DIGITRIO: CONSTRUCTING THE SERVOS**

**RADIO CONTROL**

FEBRUARY | 1966 | 50¢

# **MODELER**

**THE LEADING MAGAZINE FOR RADIO CONTROL**



**MOLD YOUR OWN FIBERGLASS FUSELAGES**



# VECO QUALITY

## KITS



### Jim Kirkland's BEACH COMBER

The most complete RC kit you can buy for standard or proportional RC. Perfect for training or contest flying. Simplified construction includes precision die-cut full-size fuselage sides, 4" wing balsa, complete hardware package including nose gear, Nylon bell cranks; full-size detailed plans showing receiver, servo and mechanical installation of three RC equipment options. See the Beach Comber at your dealer. R-5.....\$29.95

## ENGINES

### Veco 45RC



Power your new Beach Comber, or any other large RC ship, with the Veco 45RC, the engine that has been used by more national and international contest winners than any other engine. The Veco 45RC is the choice of experts for full-range power and reliability for sport or contest flying.

bore .850 • stroke .820 • displacement .465  
• safe idle 2000 rpm • coupled exhaust/  
intake throttle control

Send for our free booklet, "How To Obtain Reliable Idle & Maximum Performance From Your VECO 45RC," by Clarence Lee. GP-45RC .....\$34.95

## FUEL

### Veco Power Fuel 1

Here is the fuel to insure optimum performance for your Veco engine. Veco Power Fuel 1 is blended to provide even-burning-power from idle to maximum RPM. And it lubricates your engine efficiently for long-life and trouble-free operation.

The perfect fuel for R/C • Free-Flight • C/Line

95c/pint \$1.65/quart \$5.95/gallon

Ask for VECO products at your hobby dealer  
... engines • engine accessories • tanks  
• wheels • spinners • hardware/send 10c  
for 1965 catalog.



**VECO PRODUCTS CORP.**  
P. O. Box 229, Burbank, Calif.  
a subsidiary of Henry Engineering Company  
MP65403

# RADIO CONTROL MODELER

FEBRUARY 1966

VOL. 3 NO. 2

Editor • Don Dewey  
Production Editor • Chuck Waas  
Contributing Technical Editor • Ed Thompson  
Art Editor • Dick Kidd  
Art Assistant • Barry Halsted  
Contributing Editors •  
Ken Willard  
Jerry Kleinburg

Gary Preusse  
Bernie Murphy  
Chuck Cunningham  
Foreign Editor • Cliff Rausin  
Club and Contest Editor • Kathleen Acton  
Special Projects • Bill O'Brien  
Administration & Reader Service •  
Betty Rives

## Features

THE WYANDOTTE STORY	6	
THE STREAK	14	Jerry Kleinburg
1ST INTERNATIONAL AEROCLASSIC	19	Chuck Waas
THE PIKOLO	22	Hoh Fang-chiun
RCM DIGITRIO: SERVOS	25	Ed Thompson
BUILD YOUR OWN FIBREGLASS FUSELAGES	36	D. W. McTaggart
THE DIGITAL DECABULATOR	42	Ed Thompson

## Departments

EDITOR'S MEMO	5	Don Dewey
SHOWCASE '66	16	RCM Staff
REGATTA	40	RCM Staff
N.M.P.R.A.	43	NMPRA Staff
KITS AND PIECES	44	Bernie Murphy
CUNNINGHAM ON R/C	47	Chuck Cunningham
TOP OUT	48	Jerry Kleinburg
SUNDAY FLIER	49	Ken Willard
THE ROOSTERTAIL	53	IMPBA Staff
THE LAST WORD	72	

## The Cover

The magnificent and versatile Lake Amphibian pictured in an ideal setting for a weekend of fishing at the lake. Photo courtesy of Lake Aircraft Corporation.

### R/C MODELER CORPORATION, Publisher

Editorial and Advertising Office

P. O. Box 487

Sierra Madre, California 91026

Phone (213) 356-1066

Phone (714) 494-0768

Business and Circulation Office

P. O. Box 1128

Laguna Beach, California 92652

Phone (714) 494-0768

Official Publication of  
The National Association of Radio Control Clubs  
International Model Power Boat Association  
National Miniature Pylon Racing Association

Subscription service: All subscription correspondence should be addressed to R/C Modeler Circulation Dept., P. O. Box 1128, Laguna Beach, California. Please allow at least six weeks for change of address. Include your old address, as well as new — enclosing an address label from a recent issue wherever possible.

Editorial contributions: must be accompanied by return postage and will be handled with all reasonable care. Publisher assumes no responsibility for return or safety of art work, photographs, or manuscripts. Address editorial contributions to The Editor, R/C Modeler Magazine, P. O. Box 487, Sierra Madre, California.

Subscription rate: One year, \$5.50, 2 years \$10.00. Canada, one year \$6.00. All other countries, one year \$6.50. Payment from all countries must be in U. S. funds.

R/C MODELER MAGAZINE is published monthly by the R/C Modeler Corporation. Contents copyright 1965. All rights reserved. Printed in U.S.A. Second Class Postage paid at Milwaukee, Wisconsin and at additional mailing offices.





# EDITOR'S MEMO

by Don Dewey



**T**HE first part of this month's Editor's Memo is by guest editorialist Bob Benjamin. It is well worth reading. It speaks, I believe, for all of us.

What does modeling mean to you?

Whether you are an R/C flyer, a free-flyer, or a control line enthusiast, the words "model airplanes" have a special significance for you.

Models have a certain inescapable charm, well attested to by the ever-present crowds of small boys at flying fields and the recurring question of their fathers (who are usually never far behind)—"Say—do you think we could build one of those?"

The same attraction has its hold on us. What else could keep us building and flying in spite of remarks about "grown men playing with toy airplanes," or gale winds that always seem to blow or Sunday afternoons or neighbors with power mowers who complain about our engines?

I cannot presume to speak for anyone other than myself, but I think that models being what they are, that some of what I find worthwhile in the hobby may have meaning for someone else. Some of the rewards, by their very nature, go beyond being merely personal.

Let me say from the outset that I am not a competition modeler. I have never had either the time for sufficient practice or the money for the equipment necessary for specialized contest flying. I suppose I am what Ken Willard describes as a Sunday Flier. If the nationwide polls are correct, this places me in an excellent position to talk to the majority of my fellow modelers.

Most of us have something in common. I began building models just as soon as I was old enough to stick the pin in the glue tube without skewering a finger. The first model I remember was a solid display model that my father brought home when I was five years old. I wonder if he knew what he was starting. Since that first ship I progressed through more solids, the usual run of plastics, a succession of pre-fab rubber jobs, and finally to my first "gas engine." I now count among my building and flying experiences, hand launch and towline gliders, sport and competition type free flight models, an occasional rubber job, control line planes

from some wild half-A combat ships to their larger counterparts, scale, stunt, and a succession of R/C ships on escapements, servos, and proportional. These varied aircraft have given me a few impressions that I think are worth sharing.

Most of us will agree that models have a certain charm about them. I like to think of it as exemplified by a free flight model I designed when I was in junior high school. After looking at dozens of magazine-published contest models, I decided to try my hand at the game. The model may not have been a world-beater, but it was **mine!** I remember a blue and yellow polyhedral wing on a pylon, a boxy fuselage, and a well-used .049. The first flight was unforgettable. It was just before sunset at a large deserted field that had once been an airport. A friend held the ship while I cranked up the engine, then apprehensively watched me launch. The model climbed out of my hand at a moderate angle, circled to about a hundred feet before the engine quit, then settled into the flattest, most beautiful glide I have ever seen. The landing was a soft slither into the grass some forty feet away. No contest flight, to be sure, but the heady mixture of pride, relief, and joy I felt was far better than any trophy.

Other "accomplishments" come to mind. Models spur us on to try the difficult and compete. I recall the first time I managed to fly a close approximation of the control line stunt pattern. Closer to home was that supreme moment when, after deciphering the seemingly endless intricacies of gadgets and flight adjustments, I managed that first solo radio controlled flight—and wonder of wonders—a right side up landing at my feet! It was worth all the trouble and then some! After that flight I felt as though I'd "arrived." And who of you, having experienced it, can deny the pride you feel when another modeler, looking at your brand new creation says—"Gee . . . I wish I could build a model like that!"

One of the greatest pleasures is a recurrent one. We modelers do not claim to be an exclusive lot. I like to

(Continued on Page 9)

## TWO NEW ORBIT SERVOS

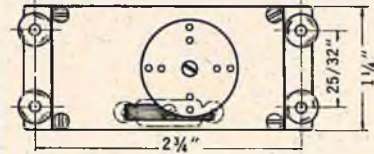

PS-2A and PS-2D dimensions are identical. Servo weight 3 oz.

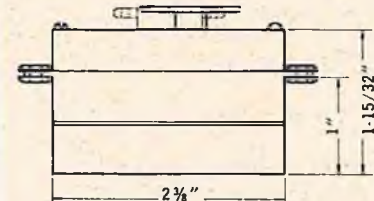

Two completely new high-torque Orbit servos are now being delivered as standard equipment with all Orbit RC systems and are compatible with previous Orbit gear. PS-2D servos are used for all seven channels of the new Orbit 7-14 digital proportional. PS-2A analog servos are used for "full-house" throttle, aileron and elevator functions; rudder control continues to use the PS-1A servo. All 3 + 1 controls utilize the new PS-2A.

Linear and disc output are built into each servo so that mixed methods can be used in a single system installation, or so changes can be easily accomplished.

Advanced circuitry, a new precision motor, silver alloy brushes and a hard surface carbon/ceramic potentiometer combine to deliver twice the power of previous designs. Full-power servo output on minimum error signals assures positive control.

The all nylon case provides vibration-dampening grommet mounting positioned for maximum crash protection and ease of installation.

PS-2A analog servos . . . \$40.00 each  
PS-2D digital servos . . . \$40.00 each

SEE YOUR DEALER OR WRITE:

**Orbit**

**Electronics**

11601 ANABEL AVENUE, GARDEN GROVE,  
CALIFORNIA

Manufacturers inquiries  
invited.

© 1965 Orbit Electronics, Inc. mp65432



**Graham Radio Supply**  
Pamplico, S. C. 29583

**DEALERS OF ELECTRONICS  
EQUIPMENT FOR MODEL  
CONTROL  
SEND FOR CATALOG  
Phone 803 493-5692**

We don't have a monopoly on the lowest prices — but we can match any offer: If you're closer to us, you are assured of faster service from our large supply of all Brands: Cash or Trade for your used Multi R/C sets and old Ignition motors. Over 100 Ready-to-fly R/C planes in stock: Special Bargain Bulletin 10c.

**Nashville Hobby Center**  
903 Church Street  
Nashville, Tennessee

## **DIGITRIO BUILDERS TRANSMITTER CASE**

COMPLETE WITH STICK  
HARDWARE, MOUNTING  
BRACKETS, FASTENERS  
AND ALL TRIM POT  
HARDWARE. ALL HOLES  
PUNCHED. GRAY ANODIZED.

**\$11.95**

CALIF. RESIDENTS ADD 4% TAX

DIRECT FROM:

**JUSTIN, INC.**  
BOX 135  
SAN GABRIEL, CALIF.  
Telephone: (213) 444-4516



The Indian City R/C Club float in the last Fourth of July parade. The radio controlled Tin Lizzy by Bill Bertrand.

## **THE WYANDOTTE STORY**

### **The Indian City R/C Club and its Contribution to Model Aviation and its Community**

**T**HE Indian City Radio Control Club was formed on the Lower Peninsula of Michigan, an area known, not only for its scenic beauty and vast auto production, but also for its rich historical lore. Located in Wyandotte, Michigan, just ten miles southwest of Detroit, the club has grown from five members in 1953 to fifty in 1965, and is one of the most active in the Detroit area.

As with most R/C clubs, they are a by-product of the old "ukie" days, having banded together for self-protection — a 'requirement' for several active members to chase the fly-aways in those early days of our hobby!

As the years passed, and flying fields became almost non-existent, it was ap-

parent to the Indian City group that if the club was to continue to grow, a new approach must be made toward cementing a friendly relationship with their community. Thus began an era of "selling" R/C to the general public — especially to the neighbors adjacent to their flying site!

A program of public service and education was adopted and they began to actively participate in various community affairs. The Annual Fourth of July Parade is one of the Wyandotte community's biggest projects, and the R/C club participates by entering a float each year. Their entry usually places

*(Continued on Page 61)*

Norm St. Pierre and original Goodyear design.



Herb Zelenka of Pensacola, Florida, at recent ICRC meet.





## EDITOR'S MEMO

(Continued from Page 5)

think I can help support this ideal. Every few weeks during the flying season I have the good fortune to drive by one of the local flying fields and discover there a boy—usually with his father—baffled by the refusal of his half-A radio ship or ready-to-fly control line model to work. After a few adjustments, a new set of batteries, or perhaps a reassuring hand on the control handle for a few laps, a brand new modeler is starting down the same road we have had the good fortune to discover. The look on that boy's face when his model flies is worth far more than just the time it took to help him.

I can't help thinking that modeling gives us a feeling of belonging, too. There is a spirit to the whole thing which, once it is started, not only makes us feel as one with all the other modelers we know, but also keeps us going

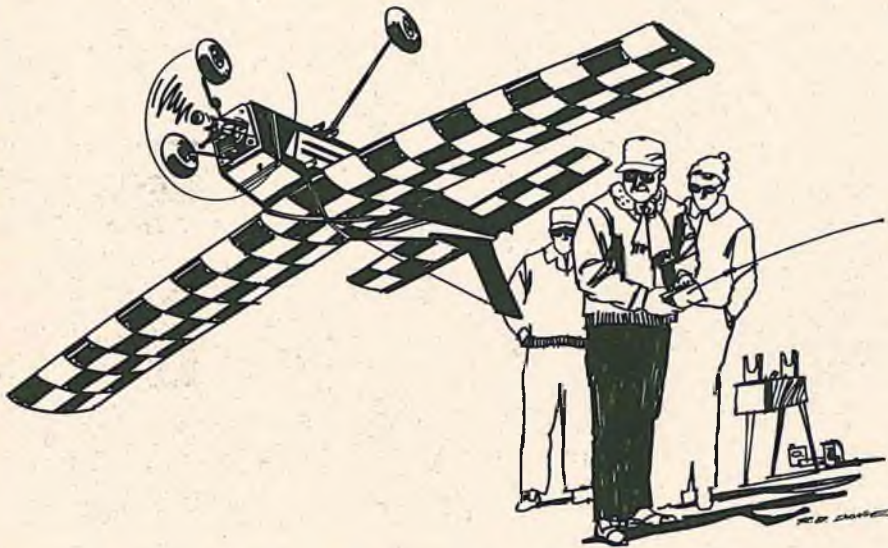

through all the sticky spots. That spirit is very catching. I have seen it at its best.

This is my hobby. The wonder of flight, the spur of challenge, the pride of accomplishment, and the comradeship of all other modelers are all part of it.

I shall back it for a long time to come.

— BOB BENJAMIN

Bob said it all . . . or just about. Most of us have a deep rooted feeling for modeling that goes back a long way to the open fields and free flight, Comet Zippers, Playboys, Bootstraps and Super Aerotrol receivers. And in that group, a great many of us are fortunate enough to have wives who enjoy modeling, who may even be active RC'ers, themselves, and kids who are either participating in model aviation, or showing an interest in becoming a part of this hobby. Families with a common

interest in modeling are one of the greatest rewards we can reap.

For this reason, it was rather discouraging to read a so-called "article" in a West Coast R/C club newsletter signed by one "Count Marco." Whether or not the author was purporting to be serious or humorous was somewhat in doubt. We can only hope that it was the latter. If it was intended to be sincere, then we hope it reflects only the opinion of the writer, and not of the entire club which the newsletter represents. Here are a few excerpts from that column, with the names of the club and individual members deleted:

"What's happened to (Deleted)? It used to be that I would look forward to going to the meeting on Thursday nights. Work projects, bull sessions, movies, slides by (Deleted). Take the first meeting in October, for instance! This was supposed to be a project night. Four members brought their projects . . . other members brought

their wives and kids! You know, I've been wondering for a long time what women and children were doing at our meetings . . . they don't seem to be interested in R/C model airplanes, do they? . . . Now some of you are going to say 'some of these women are members.' You are right, but then when was the last time you saw one of these 'members' drive up to the field, take their R/C ship out of the car, set it up, start the engine, and fly? Never, ever, and you probably never will! Most of them haven't anything else to do but to sit home while hubby goes to a meeting and has fun twice a month, so they go with him. I personally like and respect the ladies . . . but I feel (Deleted) is a club of men and it should stay that way. . . . What I would like to see is the constitution amended so as to make (Deleted) a men's organization, 14 years of age and over. I know this will

(Continued on Page 10)

## BOATING at its BEST

Fibre-glass model boat kits  
for speed & sport



"Super  
Challenger"

All fibre-glass—strong and durable. The Super Challenger is 41" long, 20" wide, and weighs approximately 12-14 lbs. when completed. For the competition or sports-minded model builder. The Super Challenger has been timed at 33.8 seconds for the 1/4 mile I.M.P.B.A. oval. Complete kit—plans and instructions only -----\$49.95

"Tas"  
Engine



High torque • recoil starter • 18,000 volt ignition system • water cooling available • 1.81 cu. in. • 9000 r.p.m. • wt. 5 lbs. 3 oz. • ht. 6 1/2" • For use in the "Super Challenger" • with tool kit and fuel tank only \$41.00

Distributors for Camron and Tas  
Terms—F.O.B. Lombard, Illinois—Sorry,  
No C.O.D.'s. Add 10% to the cost of the  
order for shipping charges (\$5.00 maximum  
in U.S.A.). Dealer's Inquiries Invited.  
Complete Catalog 25c

## G.E.M. MODELS

P. O. BOX 342  
BROADVIEW, ILLINOIS 60155

## NORTHERN CALIF. R/C MODELERS

### \$ SAVE MONEY \$

ON YOUR NEW  
UP-TO-DATE  
R/C EQUIPMENT

Trade in your old R/C gear or  
engine, get the newest, the  
latest R/C system

**Buy the Correct  
Choice the First Time**

Send 25c for Latest List of New  
and Used R/C Equipment

Since 1946

## ROOT'S HOBBY HUT

6036 TELEGRAPH AVE. OAKLAND, CALIF.  
NOON TO 5 P.M. EVENINGS 7-9

**BUY IT WHERE  
YOU CAN SEE IT OPERATE**



(Continued from Page 9)

**Buy Now - Fly Now!** You install engine, controls, tank, wheels and start flying. Nothing else to build or buy! Foam wing and stabilizer sheeted with 1/16" balsa. Wing panels joined and fiberglassed. Strip aileron, rudder, elevator controls all hinged. Finished in fuel proof white. Built of the finest balsa, plywood and foam. Average flying weight of 6-7 lbs. with your .45 - .61 engine. You start enjoying flights only hours after your American Model arrives. Order now, or write for additional information!

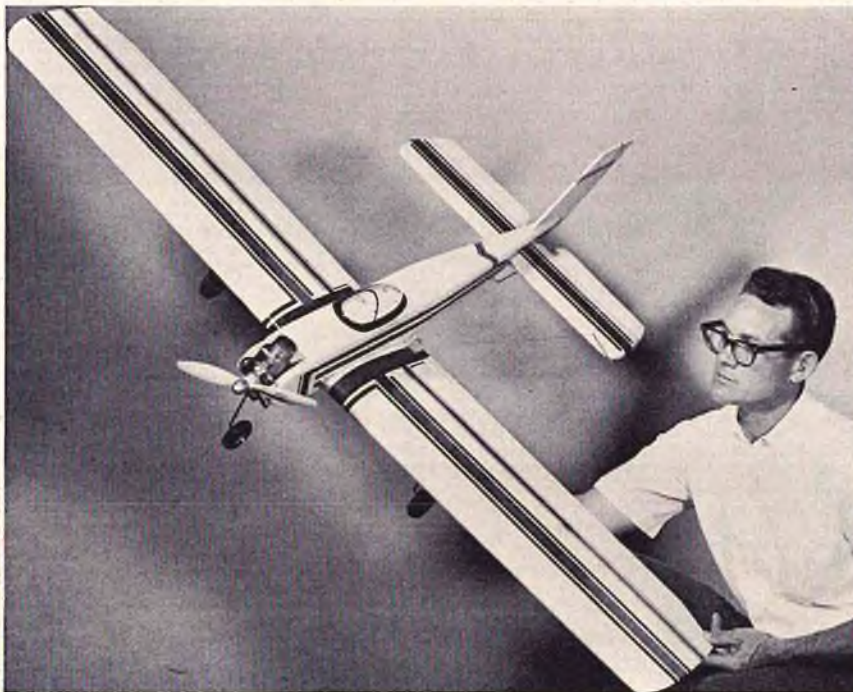

**HAWK** shoulder wing for the beginner or "Sunday flyer." 64" wing span; 768 sq. inches. Semi-symmetrical airfoil. Includes main gear and Tatone nose gear-engine mount. **\$75**

**TEMPEST** low wing is designed for the "old pro" who enjoys Class III stunt or contest flying. Performs full AMA stunt pattern. Includes Tatone nose gear/engine mount, formed main gear, and canopy. Has 66" wing span and wing area of 800 sq. inches. Gear blocks installed. Full symmetrical airfoil. **\$85**

Kansas residents add 3% sales tax. All orders shipped express collect. Mail check or money order today to:

R/C Models Division **AMERICAN PRODUCTS, INC.**



member, Kansas State Chamber of Commerce

BOX 337

SPEARVILLE, KANSAS 67876

never happen, but at least I spoke up and put in my 2¢ worth. How about the rest of you?"

Well, buster, I'll tell you about the rest of us. Not the "rest of us" insofar as your own club goes, and for whom the article was primarily intended, but the "rest of us" insofar as RC'ers go. We're proud of the ladies in R/C, whether they attend the meetings, or help with the contests, or club bulletins, or give moral support, or actively participate in R/C. If you were attempting to be humorous, Count, old buddy, it didn't come off. If you were serious, we extend our apologies on the behalf of the R/C fraternity to wonderful gals like Norma Kelly, Martha Beason, Mrs. Howard McIntee, and many, many others who have contributed so much to this hobby. To all of the ladies we extend a sincere and warm welcome — may your numbers in R/C increase!

The 'Count' may not have seen any of the girls fly, as we have, but then, perhaps he never made an effort to help them get started. The 'Count' was right on two things, though — the column, originally entitled 'Prop Wash' was changed in the club paper to 'Hog Wash.' The other point in favor of the author concerned "putting in his two cents worth."

Don't forget to count your change, Jack.

Don't forget the 7th Annual Flying Bisons R/C Conference, to be held January 21-23 at the Airways Hotel, Buffalo International Airport. If you want to see manufacturer displays of the newest equipment, or meet Hal deBolt, Bob Dunham, Walt Good, Ed Izzo, Jim Kirkland, Ed Kazmirski, Tom Brett, and many other prominent RC'ers, be sure to be there. The entire Conference, living accommodations, restaurant, bar and lounge, R/C aircraft display, manufacturer displays, club exhibits, etc., are all under the same roof at the Airways. For further information, write Flying Bisons, Inc., c/o Jim Moynihan, 297 Ashford Avenue, Tonawanda, N. Y. 14150. See you there. . .

For the benefit of those of you who wrote to inquire about the full-size biplane on a recent RCM cover — that was Don Janson's home-built Smith MiniPlane. The photograph was taken by RCM's Chuck Waas at the Lancaster Air Races. This ship, a popular favorite at Western air races, has a finish that exceeds anything we've seen on even the best of R/C models. It is a real tribute to its builder.

(Continued on Page 12)





# ANCO

## MULTI-SERVOS

(USE WITH REED RECEIVERS)  
FOR RADIO CONTROL SYSTEMS  
OF R/C PLANES - BOATS - CARS

NOW SAVE DIRECT FROM  
THE MANUFACTURER . . .  
Get All These Big Exclusive  
Features From ANCO

**FREE  
CATALOG**

<ul style="list-style-type: none"> <li>• <b>WEIGHT</b> 2R . . . . .1.3 ounces 2RL . . . . .1.7 ounces</li> <li>• <b>THRUST</b> Powerful enough for the largest models.</li> <li>• <b>TRAVEL</b> 3/8 inch straight linear.</li> </ul>	<ul style="list-style-type: none"> <li>• <b>TRANSIT TIME</b> 1/2 second from neutral.</li> <li>• <b>MOTOR</b> 5 ohm—180 ma no load.</li> <li>• <b>BRUSHES</b> 97% Silver Graphite.</li> <li>• <b>SELF-NEUTRALIZING</b> or can be set up for trim.</li> </ul>	<ul style="list-style-type: none"> <li>• <b>AMPLIFIER</b> ALL MODEL 2RL SERVOS are equipped with our 7 transistor amplifier (DK-7) that features complete burnout proof operation while adjusting centering, or if adjacent reeds are driven at the same time. DK-7 sold separately @ \$11.95 ea. postpaid.</li> </ul>
--	--	--

**MODEL 2R (RELAY) ONLY \$7.95 ppd.    MODEL 2RL (RELAYLESS) ONLY \$19.95 ppd.**

**HOW TO ORDER**

Orders will be shipped postpaid within the U.S.A. and Canada (except Air Mail—Add 25¢ each). Foreign Countries—add 50¢ each for regular mail or \$1.50 each Air Mail. **SEND YOUR ORDER TODAY!**

**ANCO ENGINEERING CO.** 7714 COLFAX AVE. SO. MINNEAPOLIS, MINN. 55423

**DEALERS — Write On Your Letterhead For Special Set-Up. Only Bona Fide Hobby Dealers Accepted.**

The can is labeled 'IDLE X' and 'GLO-FUEL'. The letter is dated October 20, 1965, and is addressed to Mr. Frank Sawyer at Midwest Products Co. in Hobart, Indiana. The letter discusses the performance of Idle X fuel.

## RECORDS Are Broken With IDLE X FUEL

**MIDWEST  
PRODUCTS CO.**

P. O. Box 88  
HOBART, INDIANA

**EDITOR'S MEMO**

(Continued from Page 10)

If you haven't already done so, read the MAN At Work column by Model Airplane News Editor Walt Schroder — the December issue. We're referring to the problem of mufflers for engines and the real, underlying problem of good public relations. Walt hit the nail right on the head. It behooves us all to do our utmost to promote this hobby via good public relations and public information whenever and wherever possible.

Speaking of public relations . . . the 1st International Aero Classic, a magnificent four day air show held at the Palm Springs Airport is now past history. This was one of the most exciting events we have ever covered — and cover it we did, since radio control flying exhibitions were part of the daily programming, thanks to the splendid efforts of the Academy of Model Aeronautics. Both John Worth and George Wells were here for the event, and their efforts at the Aero Classic will go a long way toward the public relations we need so desperately. You'll find the Aero Classic coverage in this issue.

We'll close up shop for this issue with a letter from Lester Beason:  
Dear Don: —

I can't stand to read your magazine! I am, at present, a graduate student at Eastern New Mexico University and am planning to continue to teach. What does this have to do with your fine magazine? Just this, I am dying to own my own multi-channel rig and I just can't afford to buy the radio equipment. So you can see what your mag, crammed with all those R/C goodies, does to me!

Just as a matter of information, I'm a firm believer in the hobby. At the school where I taught, I sponsored the hobby club and think that we generated a lot of interest. All of my boys were ninth and tenth graders, and we spent a lot of time in various hobbies. We were handicapped by not having a hobby shop in town, and had to order all of the equipment we used by mail, or travel ninety miles to the nearest hobby shop in Roswell, New Mexico.

I'm impressed with the caliber of material printed in your magazine, but much of it is beyond the scope of a beginner like me. I managed to buy, several years ago, a used single channel transmitter and receiver, and made several efforts to use it — thus far, though, I have run into all kinds of trouble. I have presently installed the equipment in a Falcon Jr., and am going to steal

(Continued on Page 71)



Another DU-BRO R/C First!

# NEW LOW BOUNCE ..... .....SHOCK ABSORBING WHEELS

Introduced and used at the '65 Nationals. Permanently Pneumatic. Same strong unbreakable Du-Bro Dura-Hub.

- 1 3/4" ..... \$2.19 pr.
- 2" ..... 2.39 pr.
- 2 1/4" ..... 2.59 pr.
- 2 1/2" ..... 2.79 pr.
- 2 3/4" ..... 2.99 pr.
- 3" ..... 3.19 pr.
- 3 1/4" ..... 3.39 pr.
- 3 1/2" ..... 3.59 pr.

- Also available in "SLICKS"
- 2 1/4" ..... \$2.59 pr.
  - 2 1/2" ..... 2.79 pr.
  - 2 3/4" ..... 2.99 pr.
  - 3" ..... 3.19 pr.



Regular line of Du-Bro wheels are still available.

Coming Soon . . . DU-BRO INSTANT ACTION ELECTRIC BRAKES

**DU-BRO PRODUCTS** 7667 N. Milwaukee Avenue  
Niles, Illinois 60648

*For the Utmost in Advanced . . .*  
**ENGINEERING, QUALITY, AND RELIABILITY**  
**...DEPEND ON KRAFT**

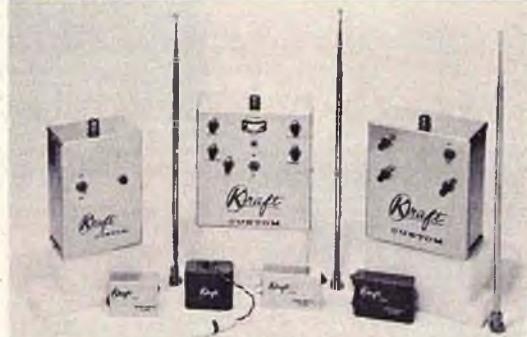

All Kraft transmitters are exceptionally powerful, drift free, and operate from inexpensive, long-life, dry batteries. The 6, 10, and 12 channel transmitters are dual simultaneous. All Kraft receivers use the same basic superheterodyne circuit whether single channel or proportional. The reed receivers are the smallest and lightest available.

**Kraft Matched Sets — Transmitter with Superhet Receiver**

1 Channel	6 Channel	10 Channel	12 Channel
\$64.95	\$119.95	\$189.95	\$209.95

Kraft Proportional System  
(now in production)  
complete system with all  
accessories, ready to install  
**\$489.95**

Kraft Heavy Duty  
600 Mah Reed Battery Pack  
**\$19.95**  
With matching charger  
**\$23.90**

*Kraft Systems, Inc.*  
2519 Lee Avenue • South El Monte, Calif.

All Kraft Custom Radio Control products are available through your local Kraft Franchised Dealer. If unavailable, you may order direct from the factory. Be sure to include check or money order for items ordered. If you prefer, you may send a 50% deposit, balance C.O.D. Calif. residents add 4% sales tax.



## THE 'STREAK'

THE 'Streak,' pictured here, won the first contest in which it was entered — a meet held at Longview, Texas, and consisting of expert competition. Howard Lincoln, designer and builder, was only able to score three flights on the first day of the two day meet, due to a personal emergency which also prevented his flying on Sunday — a perfect, windless, and clear day. Despite this, fifteen competitors, including Gordon Babbert, Gordon Dehaes, and Cal Scully couldn't overtake Howard's first-day lead achieved with the 'Streak.'

The craft handles easily, is stable, yet spins and rolls readily, has outstanding pitch capability with carrier-type landings its forte. Take-offs strongly resemble those of full-scale jet aircraft. Scale-like maneuvering during flight is also a notable attribute of this unique design. The plane flew "off the board" and went on to win its first contest with only four hours of flying time behind it. The development of the design included rubber powered, 1/2A escapement, and twin-boom prototypes. The one piece flying wing type of construction allows building in half the time usually spent on class III multi designs.

Vital statistics of the 'Streak' include a 45" span with 45 degree sweep, and an overall wing area of 800 square inches. The wing root is 29 inches with a 16% symmetrical section 4 1/2" deep. The horizontal stabilizer is 20% of the wing area, or 160 square inches. Rudder is 8%. The all-up weight is 6 pounds, 2 ounces. Power is a Veco .45 and the radio equipment is a Bonner Digimite Proportional System.

Howard Lincoln, the designer, is married and the father of two children. His wife, Dixie, is an avid R/C fan and contest helper. Howard has been active in R/C for eight years and is a design engineer for an industrial products firm in Houston, Texas.





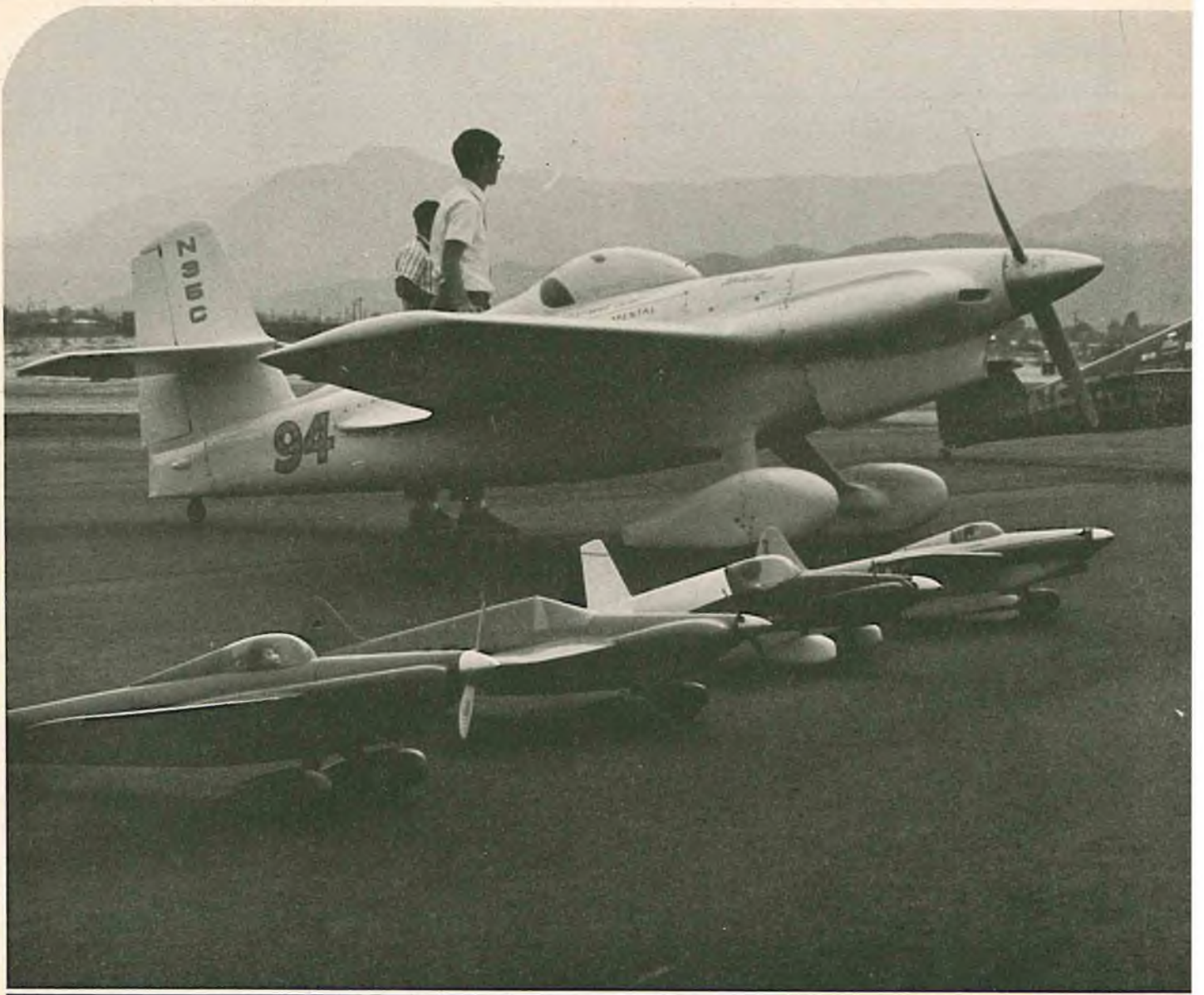

First Annual

# International AeroClassic

THE AVIATION PROGRESS  
EXPOSITION



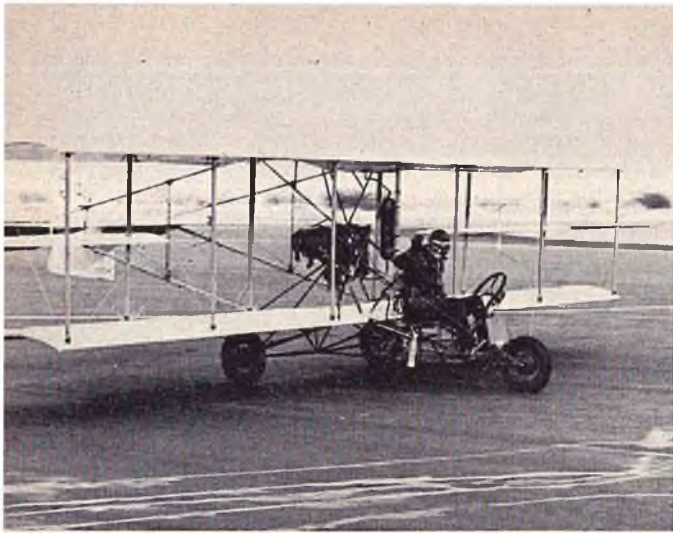

From the early pioneer days of aviation, a 1910 Curtiss Pusher. Frequent flight demonstrations thrilled spectators.



Ill-fated Lear Jet a few hours before disastrous San Bernardino air crash that killed all passengers aboard.



Miss AeroClassic for 1965

## THE AVIATION SPECTACULAR FOR 1965

RCM Covers the 1st International AeroClassic . . . A Four-Day "Olympics of the Air" That Combined All Phases of Aviation, Including R/C Goodyear and Free-Style Aerobatics.

PHOTOS BY CHUCK WAAS



Noted actor, Robert Lansing



Above: National Aerobatic champion Harold Krier in his newly designed Krier Aerobatic Special. Right: Low inverted passes were part of the exciting free style aerobatics at 1965 AeroClassic. Below: Full size midget racers at takeoff of a pylon heat.







Left: Dr. Ralph Brooke fires up his F-51 stunt ship. Right: The start of a demonstration Goodyear heat.

Radio controlled free style aerobatics and N.M.P.R.A. Good-year Pylon demonstrations were an integral part of each day's AeroClassic program. RC'ers Don Mathes, Ralph Brooke, Jerry Nelson, Ray Downs, Phil Kraft, Granger Williams, Dick Riggs, Cliff Weirick, Joe Martin, Bob Doell and others, all flying under the direction of Dick Tichenor put on three and four demonstrations a day. Two thousand dollars of prize money won by the R/C team was donated to the A.M.A. by the fliers. Several of the R/C models were chosen for exhibition during the Aero-Classic participants banquet. The U. S. and Finland control-line champions also put on a spectacular display of model aerobatics.



Top: Shoestring and team prior to a pylon heat. Above: Ray Downs' model Shoestring just prior to touch down.



Above left: Granger Williams model Nieuport 28. Above: Full-scale midget approaches the pylon. Above, right: A.M.A.'s John Worth accepts the prize money donated by R/C participants. Below: Goodyear blimp during AeroClassic landing. Below, right: Cliff Weirick's Midget Mustang taxis by spectators.





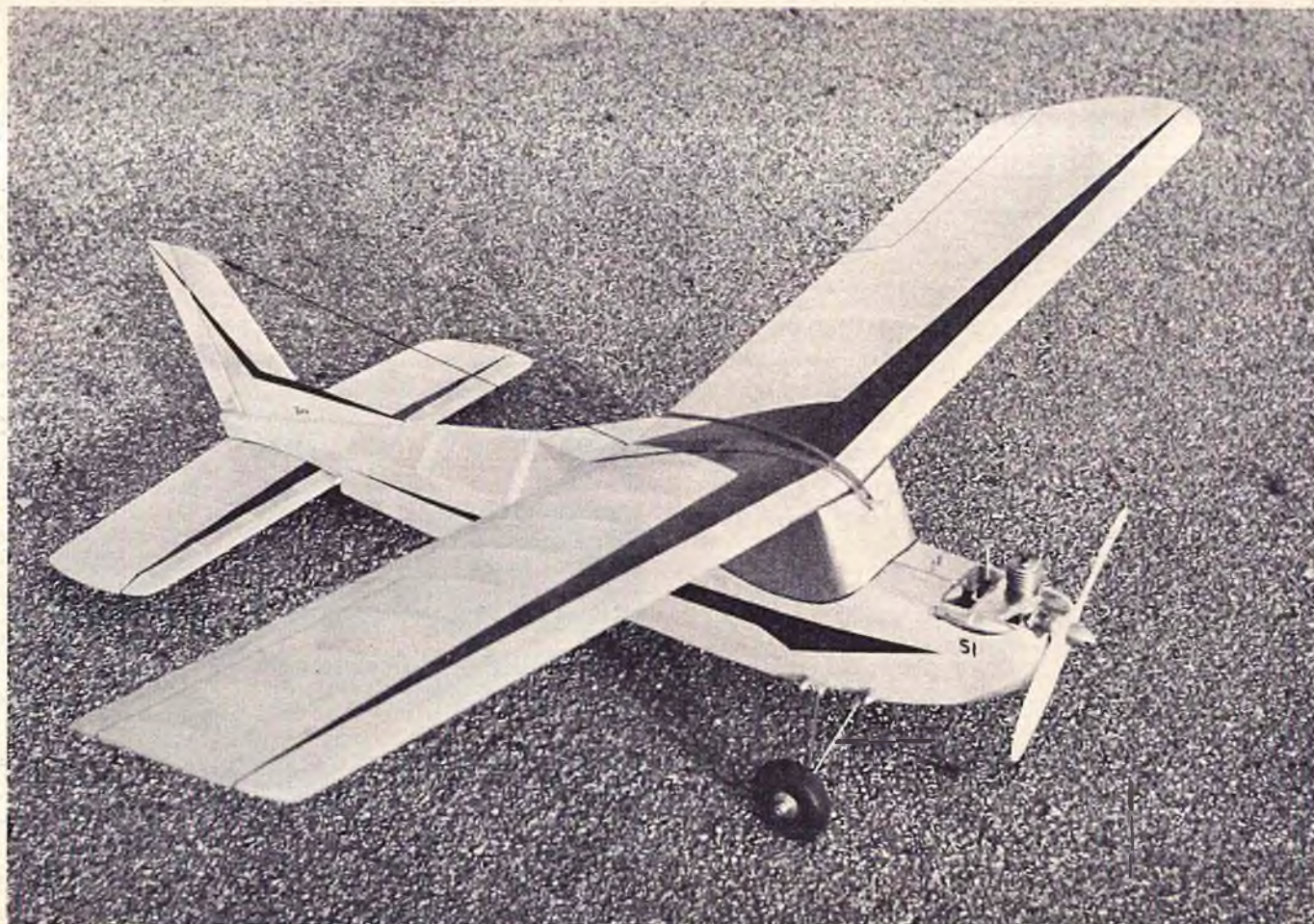

Author's prototype is good example of every day sport flier. Modelers may correspond in English, Swedish, or Chinese with Hoh Fang-Chiun, Skordevagen 8, Stockholm/Tyreso 1, Sweden.

# THE PIKOLO

BY  
HOH FANG-CHIUN

Escapements or four channel, the Pikolo is a rugged, dependable, and easy-to-handle design for the Sunday Flier.



**T**HIS Radio-Controlled Sport design is recommended if you want fun at low expense and little effort. It is easy to build, robust in construction and possesses a constant stable flight performance once the model is properly trimmed. The powerplant can be any diesel or glow engine of .09 to .15 capacity. Any radio outfit providing rudder and motor throttle controls may be readily installed. Because there are so many suitable R/C systems available on the market I did not specify any particular installation on the plan. My original prototype uses a German Variophon-Varioton R/C set, with a Bellamatic servo for rudder and a Servo-automatic servo for throttle, the installation of which is clearly shown on the photographs. The construction of the model is quite conventional, so building it should not offer difficulties even to the beginners. As can be seen

from the plan, materials used are often generous. Therefore, select only medium or medium-soft balsa wood throughout the entire model in order to keep the weight down to a minimum.

## CONSTRUCTION

Start with the wing. After cutting the ribs and spars, pin down the trailing edge directly on the plan over wax paper. Be sure that the notches are already cut in the trailing edge. When cutting these notches, make them slightly undersize for a tight fit to the ribs. Cement all ribs in place except the center rib WA, using pins to hold these in position while they are drying. Note that rib WB is cut  $\frac{1}{16}$ " undersize, top and bottom, to hold center section sheet covering. Add  $\frac{3}{16}$ " sq. top spar and leading edge stock while the panel is still on the working board.

*(Continued on Page 24)*



ALL WOOD IS BALSALUA EXCEPT WHERE NOTED

**PIKOLO**  
 DESIGNED & DRAWN  
 BY  
 HOH FANG-CHIUN  
 胡方健

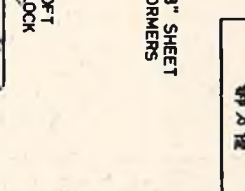
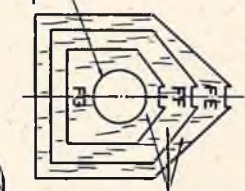
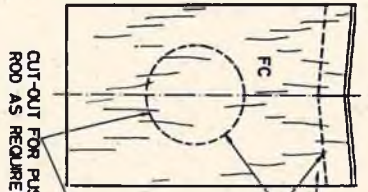
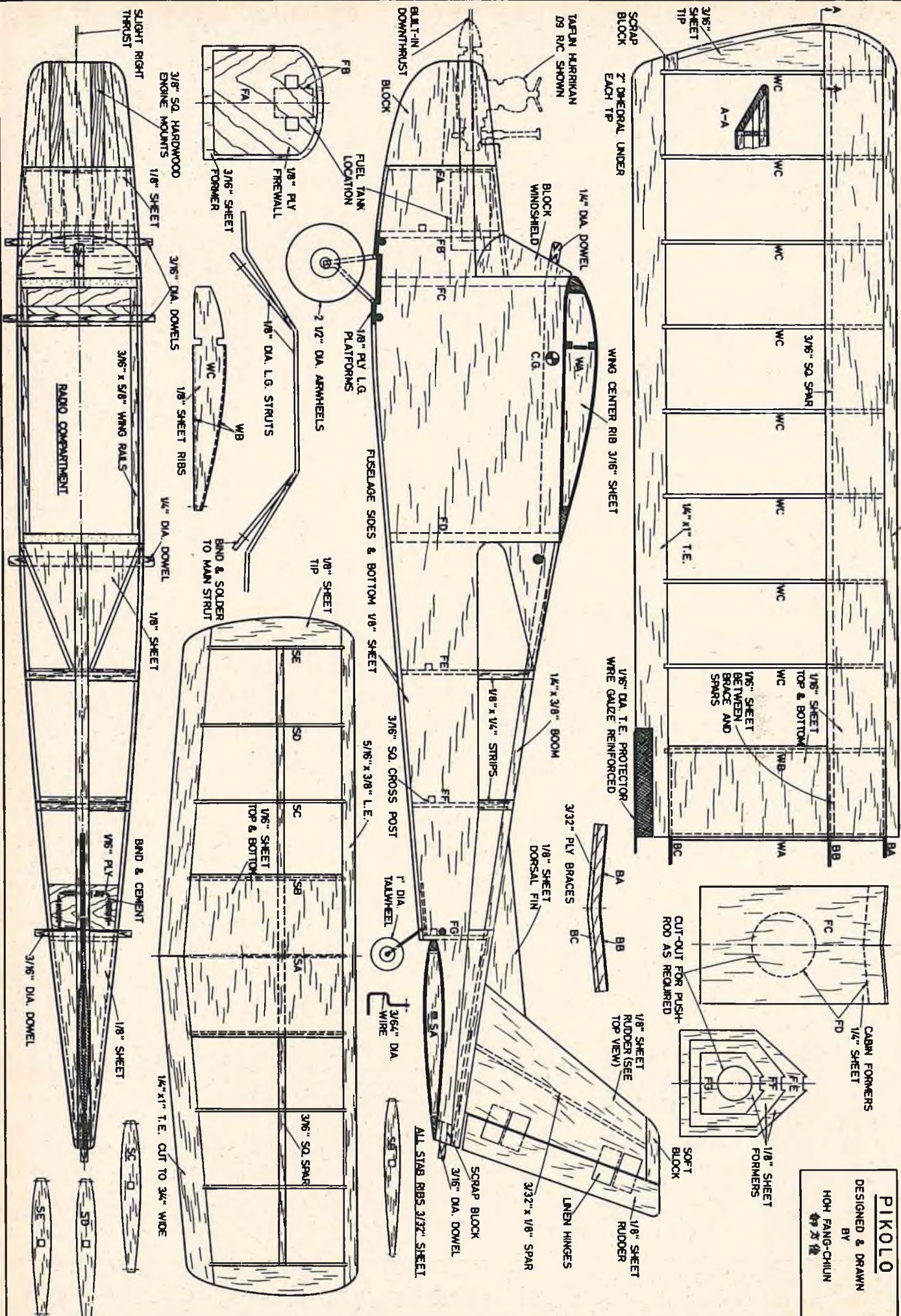

3/8" x 5/8" L.E.

3/8" x 5/8" L.E.

1/8" x 1" T.E.

1/8" x 1" T.E.

1/8" x 1" T.E.

1/8" x 1" T.E.

1/8" x 1" T.E.

1/8" x 1" T.E.

1/8" x 1" T.E.

1/8" x 1" T.E.

1/8" x 1" T.E.

1/8" x 1" T.E.

1/8" x 1" T.E.

1/8" x 1" T.E.

1/8" x 1" T.E.

1/8" x 1" T.E.

1/8" x 1" T.E.

1/8" x 1" T.E.

1/8" x 1" T.E.

1/8" x 1" T.E.

1/8" x 1" T.E.

1/8" x 1" T.E.

1/8" x 1" T.E.

1/8" x 1" T.E.

1/8" x 1" T.E.

1/8" x 1" T.E.

1/8" x 1" T.E.

1/8" x 1" T.E.

1/8" x 1" T.E.

1/8" x 1" T.E.

1/8" x 1" T.E.

1/8" x 1" T.E.

1/8" x 1" T.E.

1/8" x 1" T.E.

1/8" x 1" T.E.

1/8" x 1" T.E.

1/8" x 1" T.E.

1/8" x 1" T.E.

1/8" x 1" T.E.



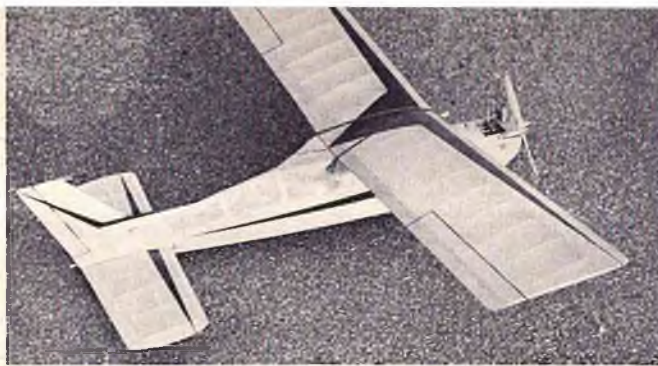

(Continued from Page 22)

Now cement the lower spar and sheet wing tip in place. The opposite wing panel is built in the same manner on the back side of the drawing. The three dihedral braces are cut from  $\frac{3}{32}$ " plywood. To join wing panels, first cement brace BB to the  $\frac{3}{16}$ " thick center rib WA, checking carefully that the joint is at right angle. Fill the gaps between brace and wing spars with  $\frac{1}{16}$ " strips and cement this unit to one panel side, allowing several hours for drying. Now join opposite wing panel very carefully with spar ends joining each other precisely. Cement the leading- and trailing-edge braces in place, using spring-loaded wood clamps to hold them in position. Complete the wing by adding leading edge- and center-section sheeting, both on top and bottom. Note that the leading edge sheeting butts against the back of the leading edge but rests on top of the spar. Finally, add the trailing edge protector wire, reinforced with gauze as shown on the plan.

The stabilizer may be built next. Note that the trailing edge is cut down to  $\frac{3}{8}$ " wide from  $\frac{1}{4}$ " x 1" stock. Since the stabilizer has a symmetrical airfoil I suggest you assemble it "in air" rather than on the working board. Slide and cement the ribs onto the mainspar, checking the alignment frequently to avoid warps. Next, add leading edge, trailing edge and sheet tips. Cover top and bottom of the center section with  $\frac{1}{16}$ " sheet before final sanding.

Start the fuselage by cutting all the components. For fuselage sides, medium-hard balsa is preferred. Cement cabin formers FC and FD to the sides and be certain that the joints are at right angle. Now cement front formers FA and FB in place and join the fuselage sides at the rear with a small balsa block. Add remaining formers and complete rear fuselage with top

boom and  $\frac{1}{8}$ " sheet covering as shown. Install a suitable metal fuel tank between the hardwood engine mounts and cover front top with  $\frac{1}{8}$ " balsa strips.

With regards to the fuel tank, I personally believe that a permanent metal one is entirely satisfactory for sport flying purposes, as in the case here. The one shown on the plan gives my model a powered flight of approximately 20 minutes. With a .15 engine a good 15 minutes engine run should be obtained.

Landing gear platforms consist of three  $\frac{1}{8}$ " plywood plates. Cement these in place. Before covering the fuselage bottom with  $\frac{1}{8}$ " sheet do not forget to cement tailwheel components in place. The tailwheel wire should be bound to the platform with heavy thread using plenty of cement. Nose- and windshield-blocks are now added and sanded to shape. Use soft blocks for this purpose to facilitate the sanding. Leave all hardwood dowels at this stage. These are glued in place after the fuselage is covered in order to facilitate the covering.

The vertical stabilizer is built up entirely of sheet. Cut two identical fin pieces from soft  $\frac{1}{8}$ " sheet. Cement the  $\frac{3}{32}$ " x  $\frac{1}{8}$ " center spar to the sheet sides and join the leading- and trailing-edges as shown on the cross section of the plan. Add a small block on top of the fin and sand it to a streamlined section. Join the sheet rudder to the fin with durable linen hinges or miniature metal ones.

Make the landing gear from piano wire or dural aluminum, the former method being shown on the plan and as used in the original model. Use lightweight balloon wheels, the air-filled type being preferred but certainly not necessary.

Finish the model by first giving the exterior balsa surfaces two coats of

thin clear dope, sanded lightly between each coat. For covering, use lightweight silk for maximum strength. To cover "open areas," that is, wing, stabilizer and fuselage rear top, it is suggested to use the wet method for freedom from wrinkles. After fuselage covering is completed cement the rudder assembly and dorsal fin firmly in place and add all the dowels as previously mentioned. Now give the entire model at least four coats of clear dope before applying any colored dope with regard to weight and future repairs. If no colored dope is used, add two extra coats of clear dope. The original model is covered with white silk and finished with red decorative lines.

Radio installation is up to you! A general rule is to house heavy components such as batteries and receiver as far forward as possible to avoid a tail-heavy condition which, incidentally, is very common for high wing designs. Also, always secure the battery and receiver packs in place against foam rubber pads.

The engine should give about 2 degrees right thrust. The down thrust may vary from model to model, so the exact amount can only be obtained through flight tests. To start with, the built-in downthrust should be sufficient for a .09 engine. More downthrust will be required if a .15 engine is used. Regarding the propeller, an 8" x 4" size would be correct both for .09 and .15. If a .15 diesel engine is used, increase propeller size to 9" x 4". Before flight attempts, be sure that the Center of Gravity location is according to the plan and there are no warps in the lifting surfaces. Glide testing is good, but not necessary if the above precautions are taken. With an .09 powerplant, full power can be used for tests while reduced power is recommended if a .15 engine is used.







# CONSTRUCTING THE DIGITRIO SERVOS

BY ED THOMPSON

Contributing Technical Editor

**T**HE Digitrio is still going strong. It survived two crashes this month due to a dead battery in the receiver pack. My test pilot ignored short range and erratic motor control on repeated flights until the inevitable happened. That's right, I said two crashes—the second exactly as the first—a result of incomplete testing, ignoring instructions and hoping for the best!

Don't let this happen to you! Above all, follow instructions and don't fly until your system is operating perfectly. If you are going to use your old reed battery pack, check it under load first. You can have defective cells that may not show up with your reed system but will cause you grief with the Digitrio. Both of the crashes this month followed the same pattern. After the surface charge dissipated one cell completely discharged. This allowed a couple of satisfactory flights followed by a "prang." During the satisfactory flights, however, the motor control was erratic due to insufficient range, and if this warning had been heeded trouble could have been averted.

I checked one reed pack after experiencing excessive noise in the system to find all the cells bad except one which the owner had just replaced. This same pack had previously been used with a reed system and according to the owner performed satisfactorily.

In all fairness to my nicads I must admit that they have been subjected to severe discharge rates and occasional

overcharges while testing the system, so, the nicads were not to blame. The point is this: if the system is not operating perfectly or changes characteristics (especially after prolonged consistent operation) don't be lulled into a false sense of security, keep it on the ground until it is right.

In testing some transmitters with more than average power output I found some RF feedback. The shield described at the end of this month's article will prevent this condition. Install it whether you are having this trouble or not. If you don't install it send me your broken crankcases—I collect them!

Rusty Fried flew the Digitrio to fourth place in Class II at the Annual

Arizona Invitational Meet sponsored by the ARCS of Phoenix. Not bad, considering that all the Phoenix and Tuscon pros showed up. He used a Tauri with a Supertigre 23. Those boys from Tuscon are tough to beat, "especially to the hamburgers!"

## THEORY OF SERVO

For want of a starting place let's consider the action of D1. D1's anode is connected to R14. D1's cathode is connected to Q1's collector. One side of C3 is connected to the D1-R14 junction and the other side to the base of Q5. Assume that Q1 is conducting. This forward-biases D1 and the voltage at the junction of R14-C3 is at ground. If we now cause Q1 to cutoff,

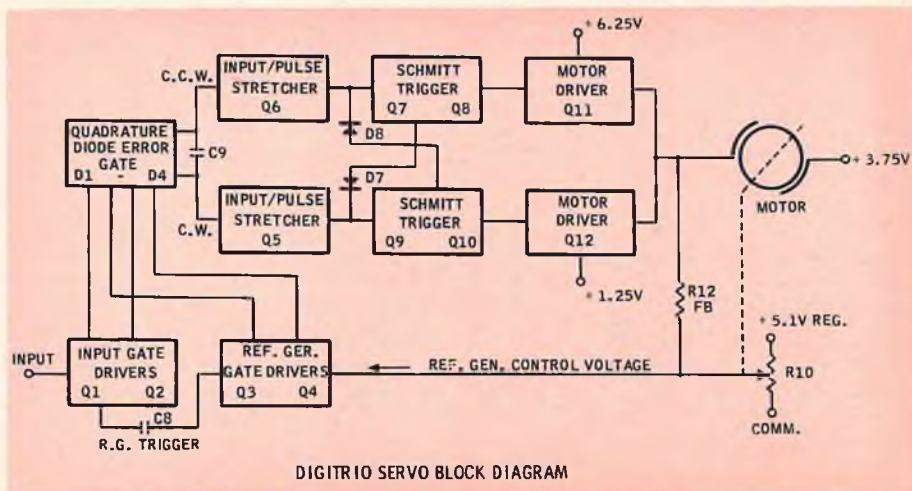



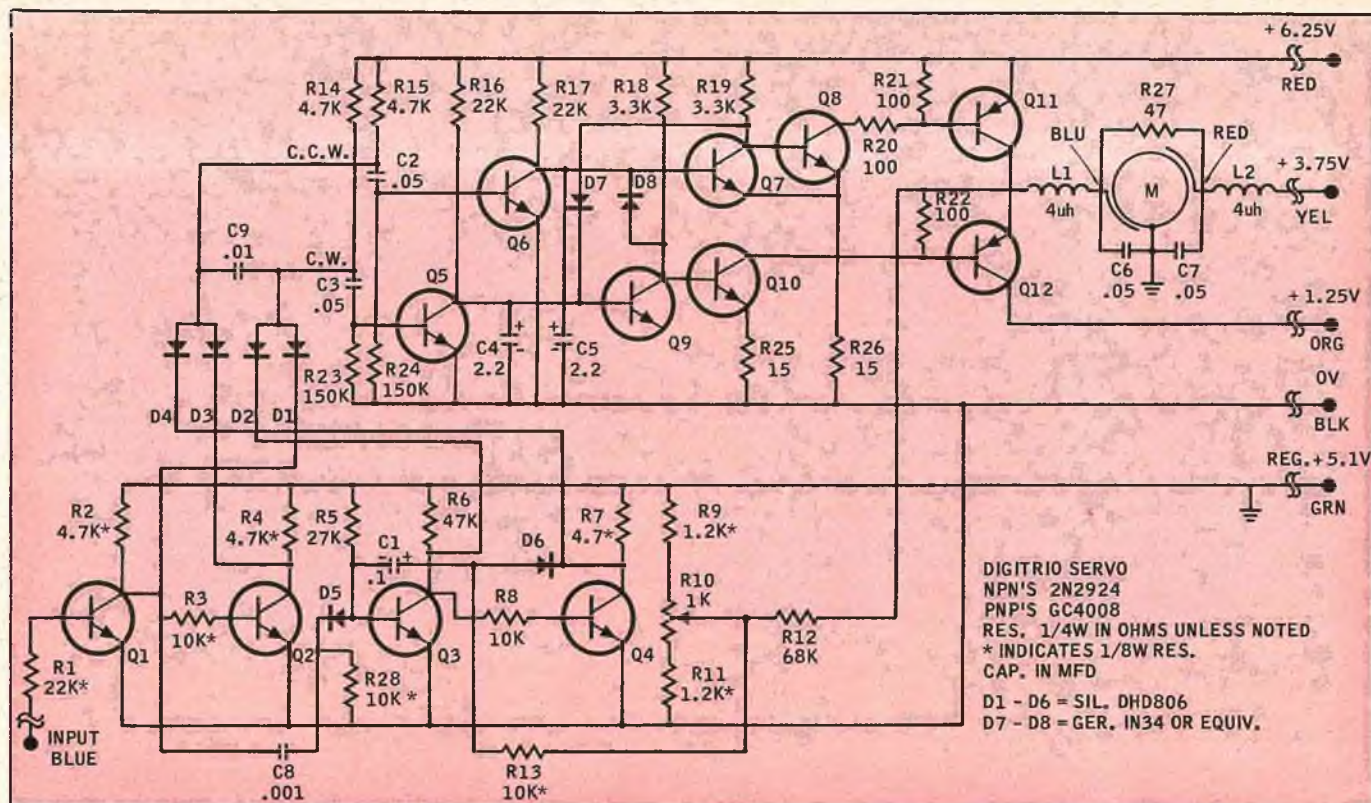

the voltage at the R14-C3 junction will rise to the positive voltage applied to the top end of R14 (in this case +6.25 V). This positive voltage will be transferred across C3 forward-biasing Q5 which will conduct. The base to emitter resistance of Q5 and R23 will discharge this positive voltage and a pulse will result. Q5 will conduct for the duration of this pulse. When Q1 conducts initially a negative pulse will result but Q5 will ignore it. Therefore each time we cause Q1 to alternately conduct and cutoff a positive pulse will appear at Q5's base causing it to conduct.

D2 is connected to the R14-C3 junction also and operates in the same manner except the positive pulse to Q5 is controlled by Q3. It is important to note here that if either diode is forward biased (either Q1 or Q3 conducting) the voltage at the R14-C3 junction cannot rise positive.

Q1/D1 and Q3/D2 work in conjunction with each other to control the positive pulse to Q5's base. Since Q5 is the input stage to the CW half of the servo amplifier the action of Q1 and Q3 controls the servo motor rotation in that direction.

The action of D3 and D4 is identical except they are controlled by Q2 and Q4 respectively. The resulting pulse in their case is delivered to Q6 (CCW half of the servo amplifier). R15, C2 and R24 form these pulses. So we can supply an input pulse to either half of the servo amplifier by controlling the operation of Q1 through Q4 which in turn controls the diode error gate (diodes D1 thru D4). Assume that the servo

is in the neutral position and no input pulses are being applied to R1.

In this quiescent state Q2 and Q3 are conducting - Q1 and Q4 are cutoff. Q2 and Q3 in conjunction with D3 and D2 respectively will place a ground at the R15-C2 and R14-C3 junctions. R10 is mechanically coupled to the output arm and will be centered - this will give a nominal pulse width of 1 MS when we trigger the reference generator (one shot formed by Q3 and Q4). If we now apply a 1 MS positive pulse to R1 we will cause Q1 to conduct and Q2 to cutoff. The leading edge of this pulse also triggers the reference generator (via C8 and D5) and Q3 cuts off while Q4 conducts. This action happens simultaneously and now we hold the pulse producing resistor/capacitor junctions at ground with Q1 and Q4. Since the changeover is instantaneous (we merely swapped diodes) no positive pulse appeared at either Q5 or Q6. At the end of 1 MS the reference generator will return to its quiescent state - Q3 conducting and Q4 cutoff. Since our input pulse is also 1 MS Q1 will cutoff and Q2 will conduct at the same time the reference generator changes state. So we again merely swapped diodes and no servo input pulses were produced. This action is the same regardless of the servo position as long as the input pulse to R1 matches the reference generator pulse. In other words the diode gate is balanced and no error pulses are produced. Let's assume that the reference generator will produce a 1 MS pulse and our incoming pulse is .5 MS wide. We will again trigger the reference gen-

erator at the leading edge of the pulse, cause Q1 to conduct and Q2 to cutoff, and swap diodes. The incoming pulse will cause Q1 to cutoff and Q2 to conduct at the end of .5 MS. Since Q3 is still cutoff (reference generator still has .5 MS to go before returning to its quiescent state) Q1 cutting off will allow the R14-C3 junction to rise positive producing a positive error pulse at Q5's base. Q2 and Q4 are now both holding the R15-C2 junction to ground so no pulse is produced here. When the reference generator returns to its quiescent state Q3 will return the R14-C3 junction to ground and the circuit is ready for another incoming pulse to compare. We will produce a negative pulse at Q5's base when the R14-C3 junction is grounded but Q5 will ignore it. Under these conditions Q5 will receive a positive error pulse each time the incoming pulse is sampled. This will cause the motor to turn in a CW direction. As the output arm moves it changes the position of the wiper on R10 to shorten the pulse width of the reference generator. The servo will continue to move until the output arm has positioned R10's wiper to cause the reference pulse and incoming pulse to be identical in width (in this case .5 MS). No error pulses are produced now and the servo will stop.

Assume now that the reference generator will produce a .5 MS pulse and we apply a 1 MS pulse to R1. Again we trigger the reference generator, cause Q1 to conduct, Q2 to cutoff and swap diodes. The reference generator returns to its quiescent state at the end of .5 MS (Q3 conducting and Q4 cut-



off). Q2 is still cutoff (the incoming pulse has .5 MS to go) and Q4 cutting off allows the R15-C2 junction to rise positive placing a positive error pulse on Q6's base. The servo motor will now run in a CCW direction until R10 is positioned to cause a 1 MS reference generator pulse. Again no error pulses are produced and the servo will stop.

I have used only three examples of pulse comparison but the action of the servo is infinite. It will respond any time the incoming and reference pulses are not identical, regardless of where the servo is positioned or where the stick is moved up to the limits of its travel.

The servo amplifiers consist of an input/pulse stretcher stage, Schmidt trigger and motor driver. Let's consider the CCW half first. Q6 is normally cutoff and R17 holds Q7 in conduction. Since R26 is common to both Q7 and Q8's emitter the base to emitter voltage of Q8 is essentially 0 V and Q8 is cutoff. The voltage drop across R26 is now dependent upon Q7's conduction. This places Q11's base at the same voltage as its emitter and it is cutoff.

If we apply a positive pulse to Q6's base its collector will go toward ground and remove forward bias from Q7. This allows Q7's collector to go positive forward biasing Q8. The voltage drop across R26 is now dependent upon Q8's conduction and the positive voltage at Q7's emitter is regenerative to Q7 tending to cut it off even further. Actually there is a discreet level at which the regenerative action takes place giving a threshold voltage for Q6 to work against. This gives a defined on and off voltage for Q11's base. When Q8 conducts the junction of R20 and R21 goes toward ground (negative as far as Q11's base-emitter junction is concerned). This forward biases Q11 which conducts. Q11's collector goes to +6.25 V which places 2.5 V across the motor (the other side of the motor is at +3.75 V). This 2.5 V is positive at the Q11/Q12 junction with respect to the battery side (yellow lead). We must convert the short input pulses into a smooth DC voltage to run the motor. C5 is charged to +6.25 V by R17. When Q6 conducts it discharges C5 rapidly due to the low resistance across Q6. It charges much more slowly through R17 when Q6 is cutoff so it holds the collector voltage below Q7's forward-bias point between pulses. This "stretches" the pulses into a smooth DC voltage for the motor. The action of the Schmidt trigger provides Q11 with either a full on or off voltage with a discreet operating point.

The CW half of the servo amplifier is identical up to Q12. When Q12 conducts the Q11/Q12 junction goes to +1.25 V. Since the battery side is at +3.75 V we have a 2.5 V voltage across the motor of opposite polarity than be-

fore. Therefore the motor turns in the opposite direction.

D7 and D8 are used to prevent Q11 and Q12 conducting simultaneously (if they do, a short, through Q11 and Q12, would practically exist between the red and orange leads). This, incidentally, could play havoc with the decoder by falsely triggering the different stages. At first glance this "double conduction" may look unlikely, however, since the servo "resolution" is so high it is susceptible to minute variations of pulse width caused by noise, etc. Since we are "stretching" the pulses this could cause both sides to conduct simultaneously. If Q6 is conducting first it will forward bias D8 removing the positive voltage at Q9's collector so that Q10 cannot conduct even if Q9 loses forward bias. If Q5 conducts first it forward biases D7 and the same thing happens to Q7/Q8. Due to other circuit considerations perfect protection is not possible, but it is more than adequate.

L1, L2, C6, C7 and R27 are used to minimize motor noise and are quite effective. C9 is used to prevent "trash signals" caused by differing rise and fall times of the components from producing false error pulses to the servo amplifiers. R9 and R11 limit the servo travel electrically. The values can be adjusted for use with control sticks having different throw measurements

than "Digitrio." Increasing their value will cause more travel and vice-versa. Resistance values of 1.5K work well with the "Bonner Stick Assembly."

R12 is used for voltage feedback to prevent output arm "overshoot." It feeds back voltage to R10's wiper that opposes the voltage change necessary for correcting its position. The closer the wiper is to the correct position the more pronounced its effect. It causes the output arm to "dampen" into its corrected position. If voltage is applied to an electric motor and then removed, the shaft will continue to rotate for a while due to inertia. This would cause the servo to coast past the corrected position and in turn be driven back whereupon it would again coast and the arm would "oscillate" trying to find the precise stopping point but not being able to. This would go on unless some mechanical damping was present or the dead band was sufficient to allow it to coast to a stop. Electrical feedback is used here to allow a minimum dead-band and nondependence on mechanical damping. The reference generator is voltage regulated to prevent trim drift. The component values have all been carefully worked out and what may appear as an innocent change could lead to decreased performance.

#### PREPARING P.C. BOARDS

( ) Make the composite P.C. board



Input: 2 volts/cm vert. 1 mill sec./cm.



A: 2 volts/cm vert. 1 mill sec/cm horiz.

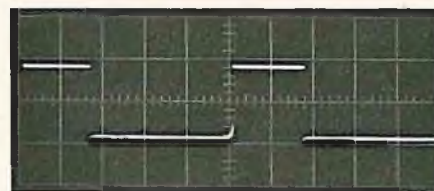

A: 2 volts/cm vert. 1 mill sec/cm horiz.

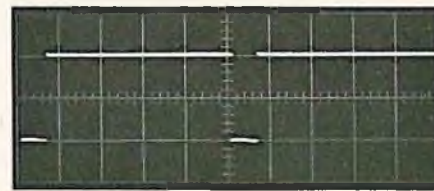

B: 2 volts/cm vert. 1 mill sec/cm horiz.

Dave Holmes submitted the following scope traces from his decoder. Dave's Digitrio on 6 meters.

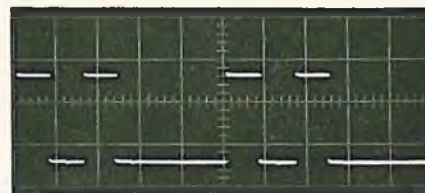

B: 2 volts/cm vert. 1 mill sec/cm horiz.



C: 2 volts/cm vert. 1 mill sec/cm horiz.

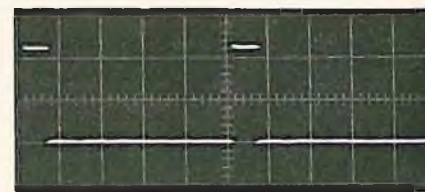

2 volts/cm vert. 1 mill sec/cm horiz. Outputs all same.



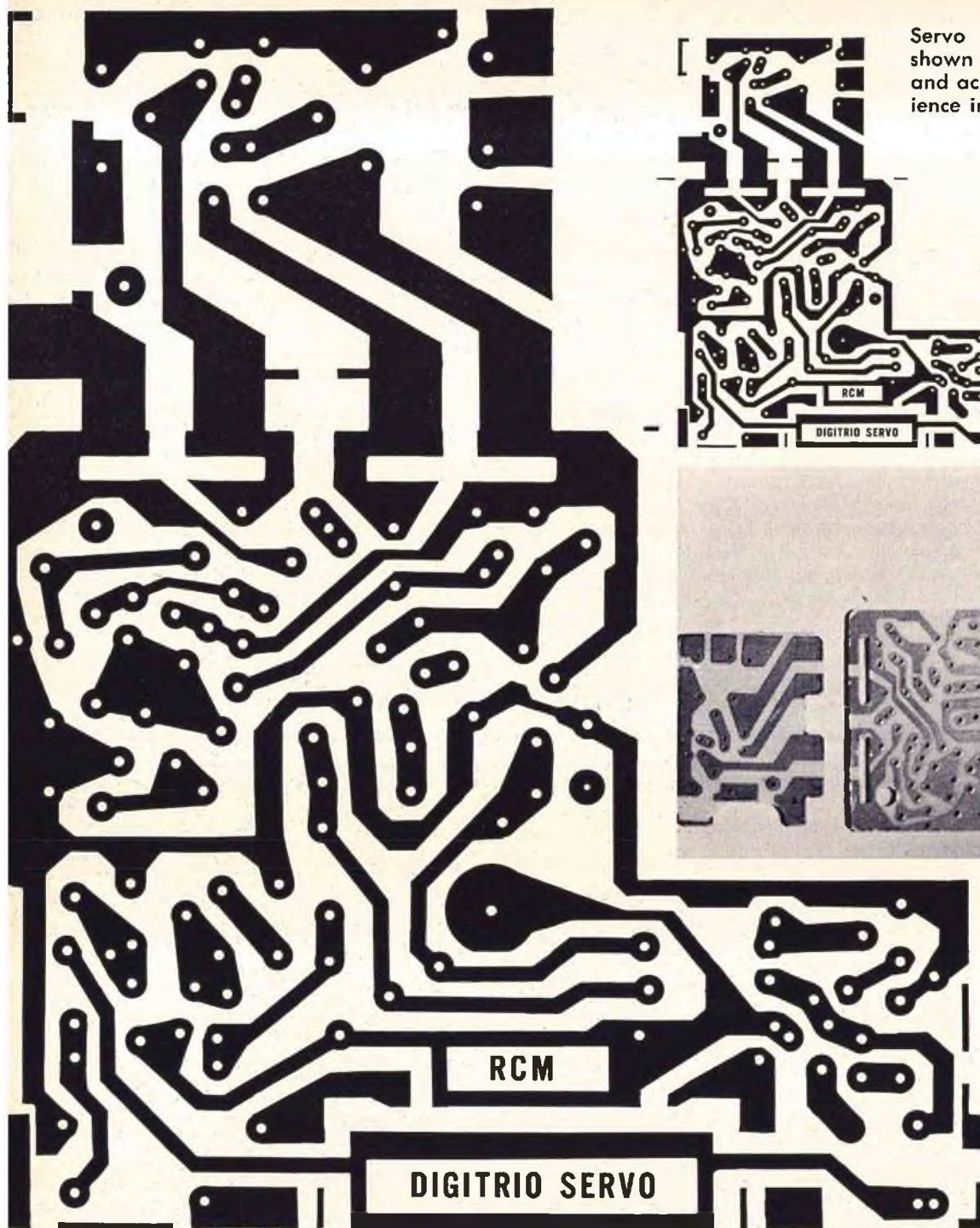

Servo printed circuit board shown three times actual size and actual size for your convenience in photo reduction.

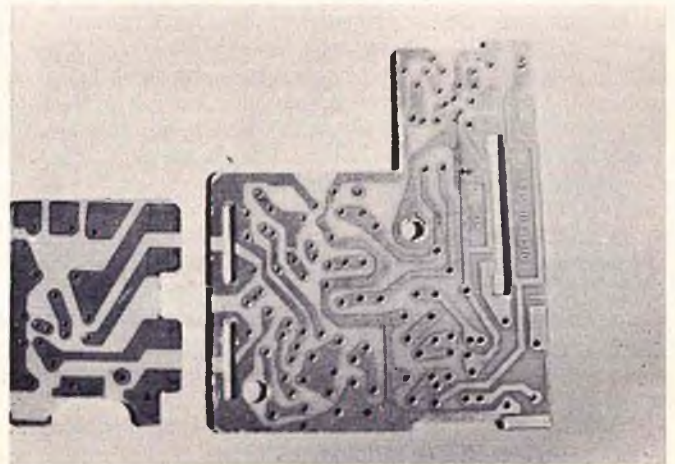

with  $\frac{3}{64}$ " stock and clean thoroughly.

- ( ) Drill all holes with a #65 drill. Enlarge mounting hole and hole B in the main board with a #42 drill. There may be an extra die hole in the board if purchased from World Engines but it will not be used. It will be in the upper right-hand corner of the main board (copper side down).
- ( ) Drill hole A in the auxiliary board with a #31 drill.
- ( ) Remove all burrs around holes in copper lands.
- ( ) Saw two thin slots as shown for insertion of brass wiper later on — use a thin Xacto saw.
- ( ) Make cutout for R10. See con-

struction overlay for exact position (fit but do not install R10 at this time).

- ( ) Cut the two boards apart where shown with a fine Xacto saw.
- ( ) Place main board on C frame and position it so that the board fits into the notches at the front of the frame and with downward pressure at rear of the board it presses into place. Front edge of the board should be flush with front of the C frame. File the board to fit.
- ( ) Fit auxiliary board into place filing as necessary so that the notches in the board fit firmly and the auxiliary board goes all the way down against the main board.

#### PREPARING SERVO MECHANISM

- ( ) Refer to figure 1 and insure that the red dot is at the bottom of the motor as shown. If not remove motor mounting screws and rotate motor. Tighten motor screws in either case.
- ( ) Scrape paint from heads of screws in back of motor.
- ( ) Cut leads to  $\frac{1}{2}$ " and solder .05 disc capacitors as shown—be sure "hot" capacitor leads don't short to motor frame. Heat-shrink tubing can be used on the "hot" capacitor leads for insurance. The easiest way is to solder leads while they are straight and then bend the capacitor down along the side of the motor.



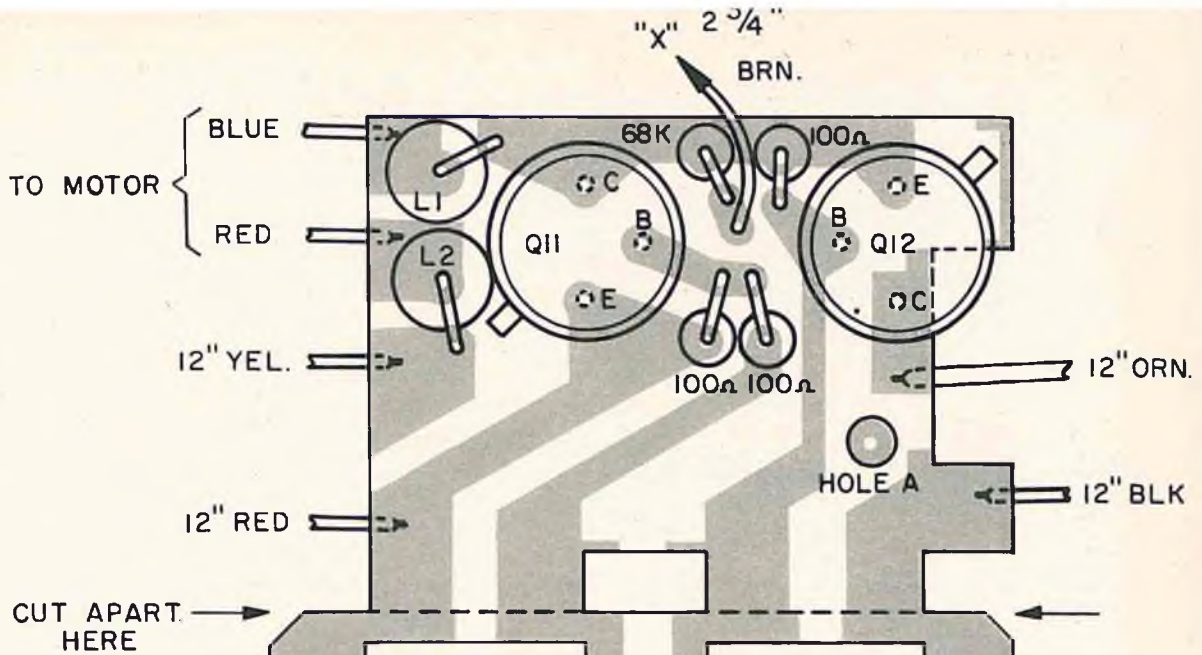

CUT APART HERE

**SPECIAL NOTE**

Errata #3 in the December issue is wrong. The .05 capacitor under L3 and L4 is C11 and no error exists. Sorry, but it shows I am on the job — I even find mistakes that don't exist.

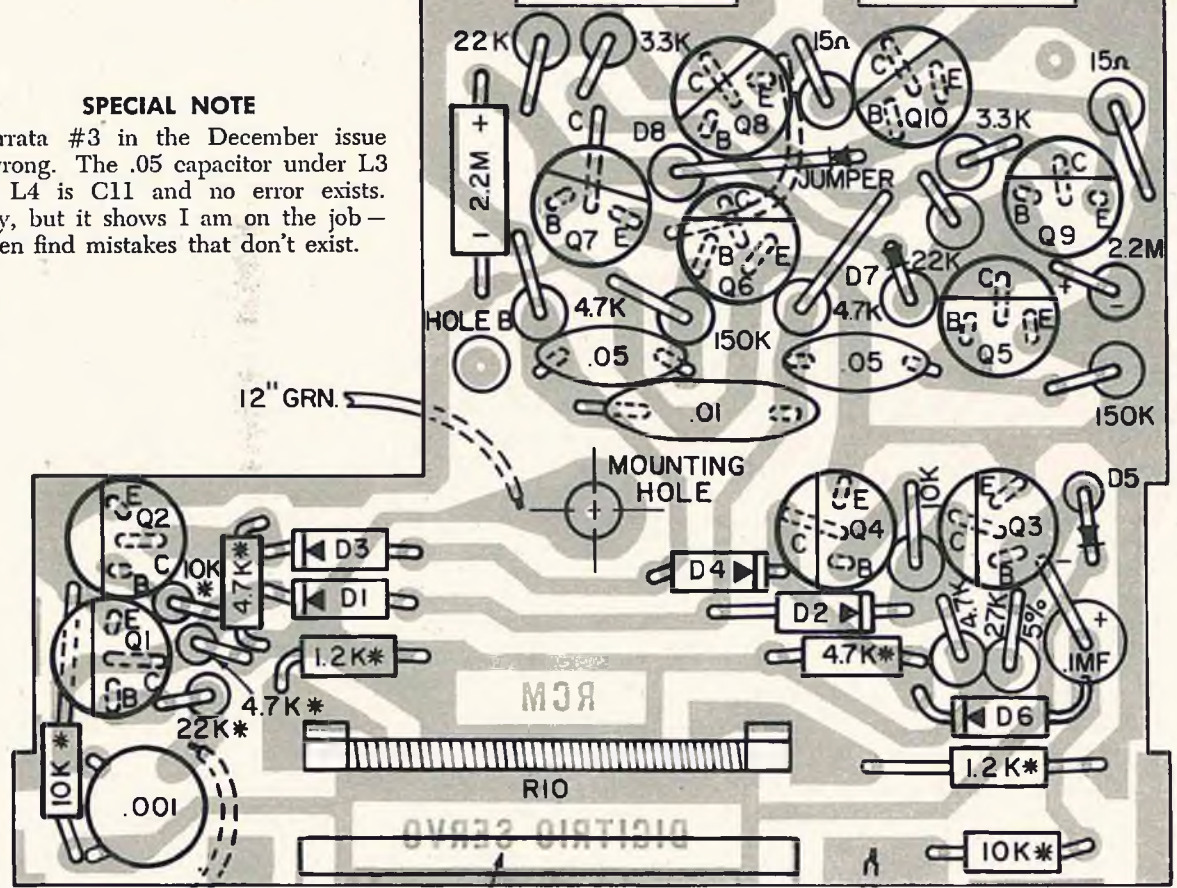

\* DENOTES 1/8 W RES.

- ( ) Solder 47 ohm resistor as shown.
- ( ) Solder 1" red and blue wires to motor as shown. Do not solder the other ends to the auxiliary board yet.
- NOTE: Make sure that no component, wire or solder mound is equal to or exceeds the height of the plastic cap on the motor or a direct "short" will exist when the cover is installed.
- ( ) Refer to the servo instruction sheet supplied with the mechanism for checking gears, etc.

**WIRING THE MAIN P.C. BOARD**

- ( ) Install all quarter-watt resistors flush with board and straight up and down.
- ( ) Mount the two germanium diodes D7 (bar down) and D8 (bar down) observe polarity — make sure D7's lead doesn't short to the 4.7K lead adjacent.
- ( ) Mount 2.2 MFD electrolytics, observe polarity.
- ( ) Mount .1 tantalum, observe polarity. Be sure your tantalum has an insulated cover or it may short to

- "C" frame.
- ( ) Mount two each disc .05's.
- ( ) Mount the .01 disc. Center the body midway between the two .05's as shown on overlay.
- ( ) Mount the .001 disc capacitor. It must be mounted close to the board and bent over flush and parallel with the board.
- ( ) Mount all silicon diodes observing polarity. The ones laying down must be flush against the board. These silicon diodes must be DHD 806's due to physical size requirements — normal size diodes will



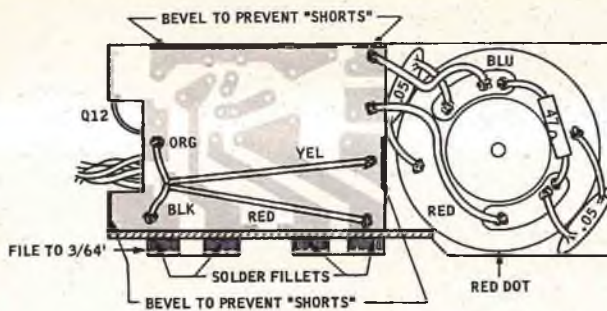

FIGURE 1 REAR VIEW

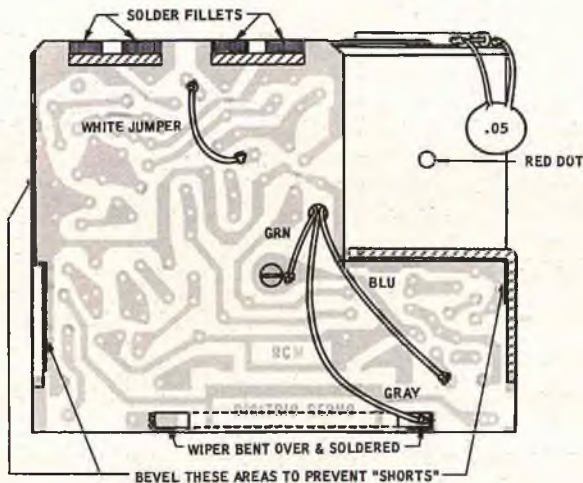
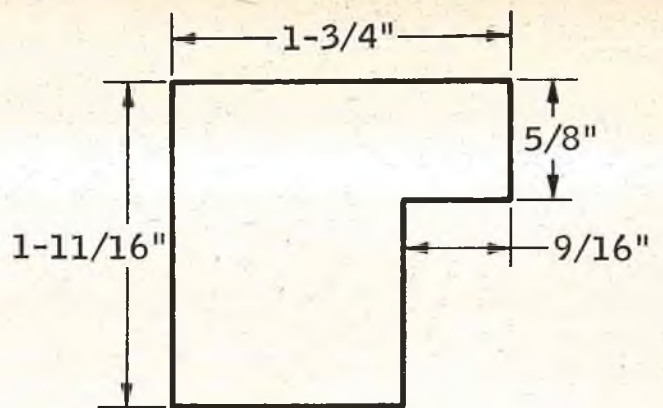

FIGURE 2 BOTTOM VIEW

- not fit.
- ( ) Mount all  $\frac{1}{4}$ -watt resistors. These are shown by an asterisk\* on the overlay and schematic. The ones laying down must be flush with the board.
  - ( ) Mount all 2N2924's. Note all collector leads must be bent out (refer to overlay for correct installation). Mount all transistors so they are approximately the same height or slightly higher than the  $\frac{1}{4}$ -watt resistors overall including leads.
  - ( ) Fit the main board onto the C frame and check for correct alignment (front edge of P.C. board should be flush with front edge of C frame). Insert and tighten mounting screw. (If Q3 and/or Q4 will not permit correct alignment, loosen the mounting screw and reheat their solder joints allowing them to shift slightly while applying corrective pressure to front edge of board.) NOTE: The emitter leads of Q3 and Q4 are close to the C frame. If sufficient clearance cannot be obtained file notches in C frame for insurance against shorting.
  - ( ) Make sure the motor body or C frame does not come into contact with any component lead. Bend any leads that are close to touching to provide adequate clearance. Insure that no lands come in contact with the C frame. Inspect

carefully the areas pointed out in the photos and drawings as potential "shorts." Use an Xacto knife or file to bevel the board in these areas removing enough copper to insure against accidental shorting. NOTE: The C frame and motor are grounded to 5.1 V and any contact in the areas mentioned will be a direct short to the battery supply.

- ( ) Remove the board and with a fine file flat the solder mounds so that they are  $\frac{1}{32}$ " to  $\frac{3}{64}$ " high.
- ( ) Clean the board of all solder resin and foreign material with acetone or dope thinner.
- ( ) Install white insulated jumper routed as shown on overlay by dotted lines.
- ( ) Mount the resistance element so that only about one quarter of the element is above the surface of the P.C. board by bending the tabs over at the bottom and soldering them. Be careful from now on so you don't damage this element.
- ( ) Install the wiper in the slots at the front edge of the board. Take care here so that the wiper lays perfectly flat against the board. Bend the wiper over on the copper side and solder the ends to the lands provided. The proper position of this wiper is slightly rearward of the front edge of the board approximately  $\frac{1}{28}$ " - don't mount it flush



1/64" SHEET

FIGURE 4 INSULATING SHEET

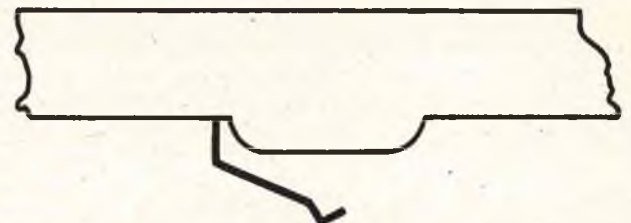

BEND ALL WIPERS AS SHOWN

FIGURE 3 WIPER ARM

as it may short to the top of the servo cover. Be careful you don't scratch, dent, etc., this wiper during installation.

- ( ) Do not install gears or operating arm at this time (we will do this later during final assembly and wiring of servo).

#### WIRING AUXILIARY BOARD

- ( ) Mount Q11 and Q12 flush against board. Enlarge lead holes slightly if they won't go all the way against board.
- ( ) Mount the  $\frac{1}{4}$ -watt resistors making sure that their leads don't contact transistor cases.
- ( ) Mount L1 and L2 making sure leads don't come into contact with transistor cases. Enlarge the holes where the choke body fits so they will mount close to the board.
- ( ) Fit the auxiliary board into main board and check for clearance. If necessary some of the components on main board may have to be mounted lower on the board.
- ( ) Remove the auxiliary board and flat the solder mounds  $\frac{1}{32}$ " to  $\frac{3}{64}$ " high with a fine file.
- ( ) Clean the board with acetone or dope thinner.

#### CONNECTING THE TWO P.C. BOARDS

- ( ) Insert auxiliary board into main board and solder in place. Make solder fillets at the four soldering





Main PC board fitted to "C" frame.

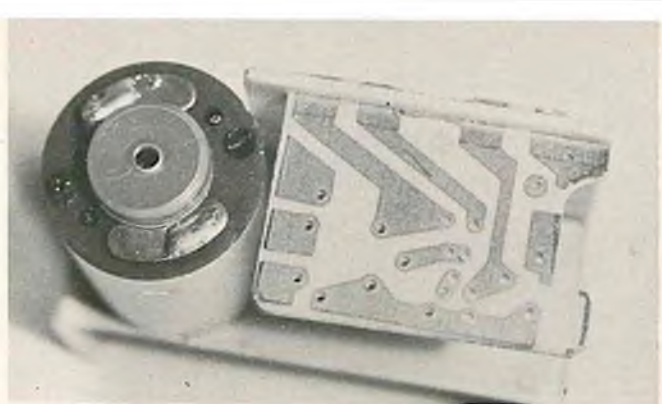

Interlocking auxiliary PC board in place.

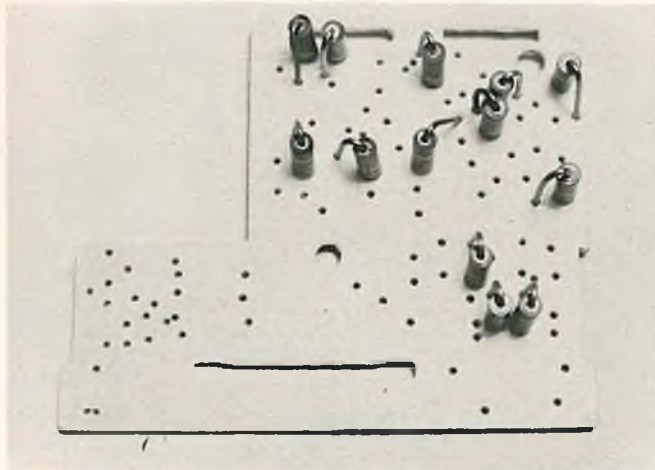

Main PC board with  $\frac{1}{4}$  watt resistors installed.

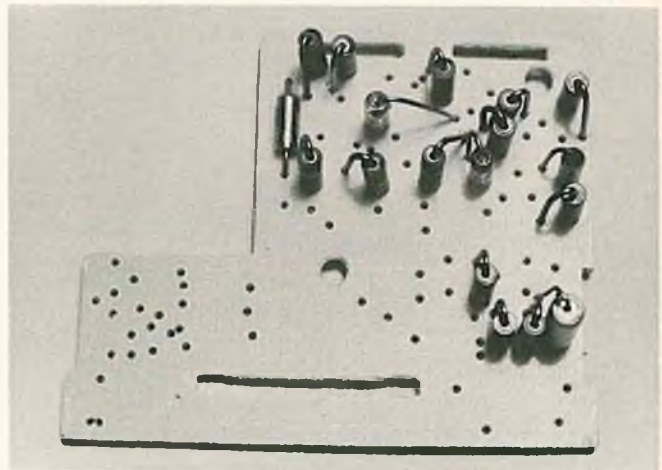

Main PC board with electrolytics added.

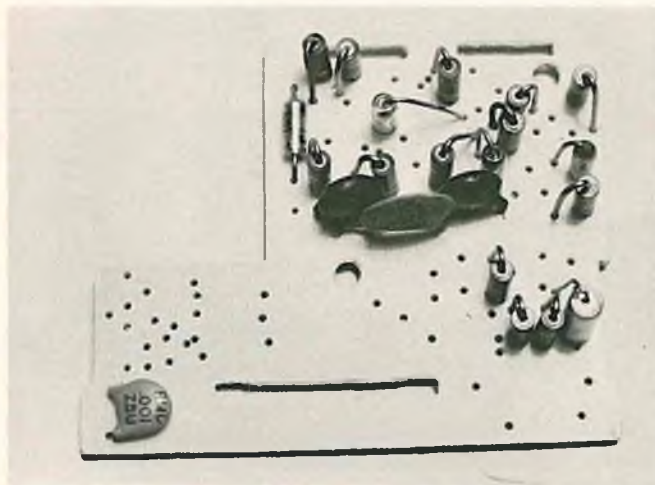

Disc capacitors in place on main PC board.

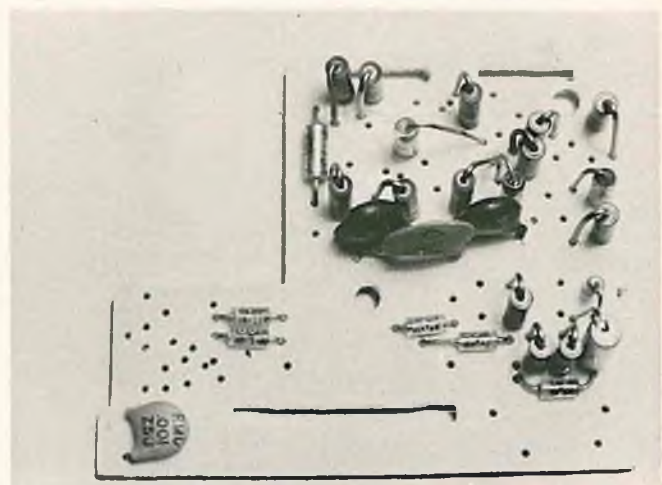

$\frac{1}{4}$  watt resistors added to board.

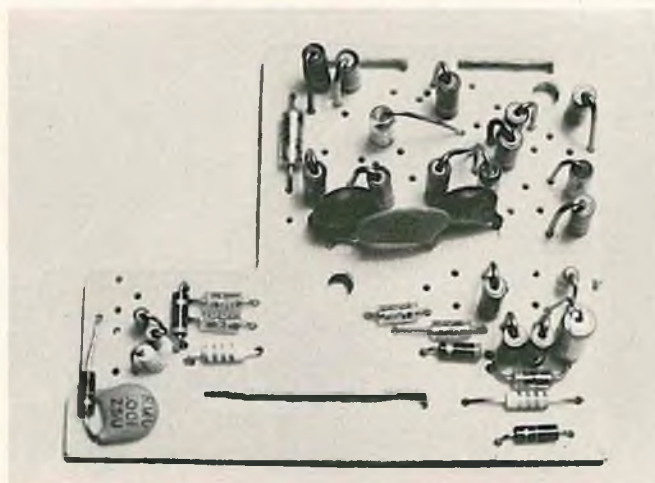

Transistors added in place on main board.



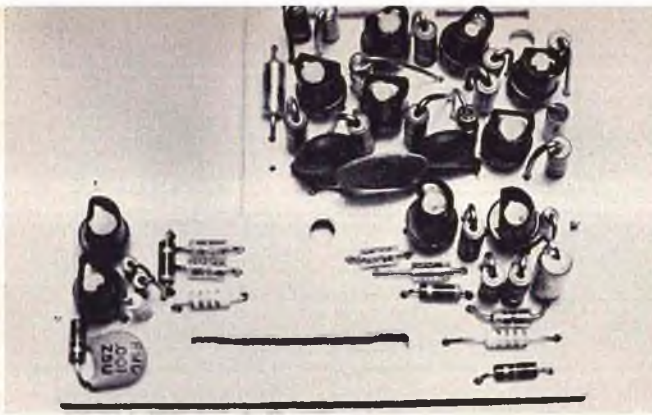

Main board now completed except for wiper and pot.

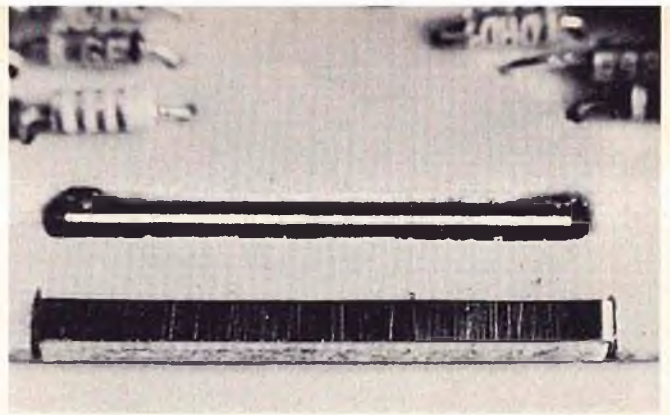

Wiper and pot installed. Follow text carefully when installing.

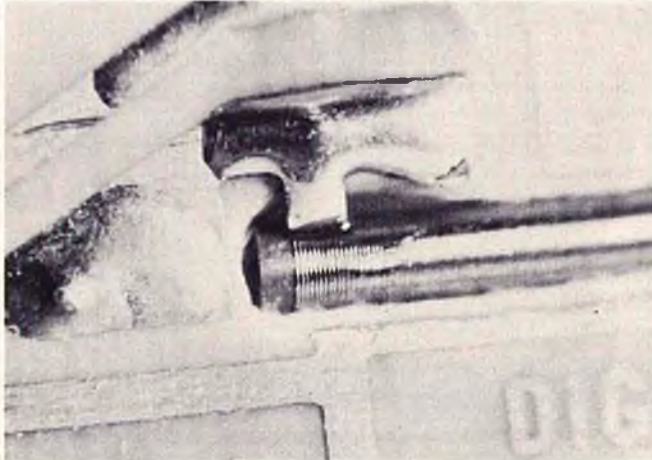

Closeup of pot tab soldered to copper PC land.



Auxiliary board with transistors, resistors and chokes installed.



View of base of main board showing routing of wires between lands.



View of base of auxiliary board illustrating motor components and servo wire routing.

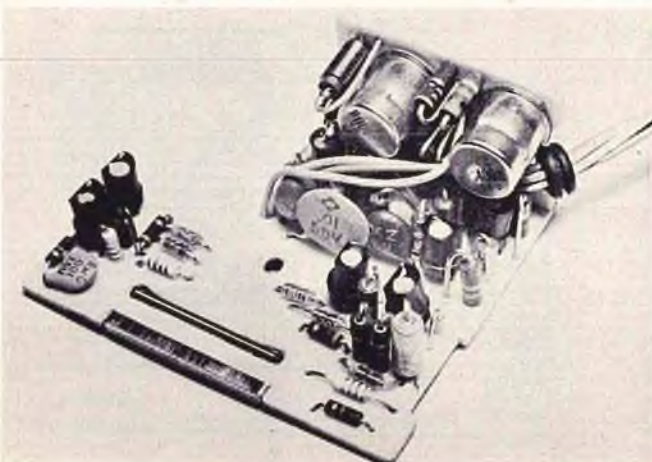

Completed servo amplifier.

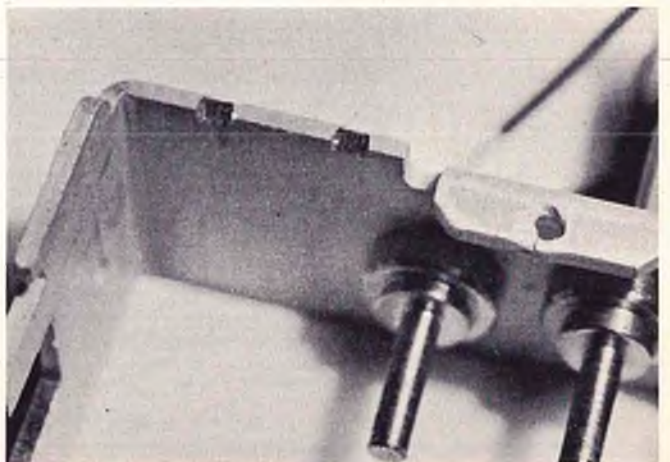

If necessary, notch C frame with file for transistor clearance.





Amplifier installed on "C" frame. Gears and output arm removed in this photo.

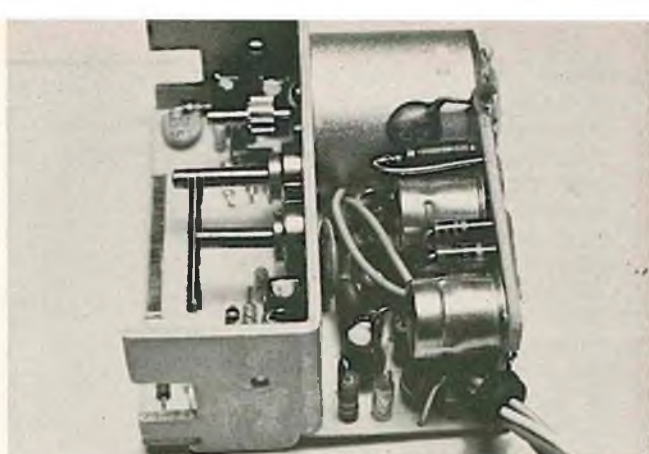

Another view of servo assembly showing auxiliary board and servo motor.

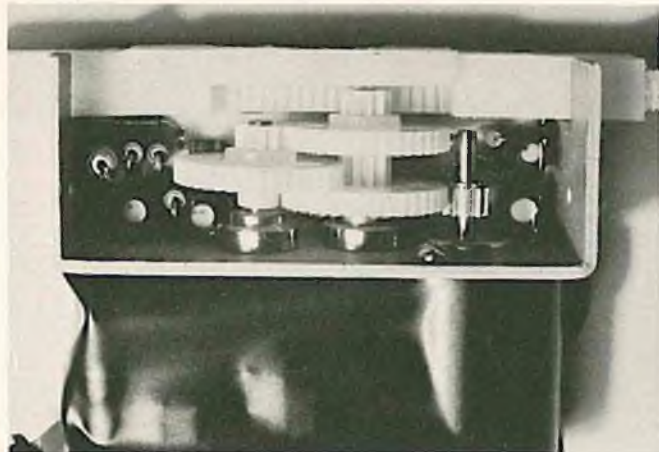

Gears and output arm installed. Note plastic electrical tape around base of frame.

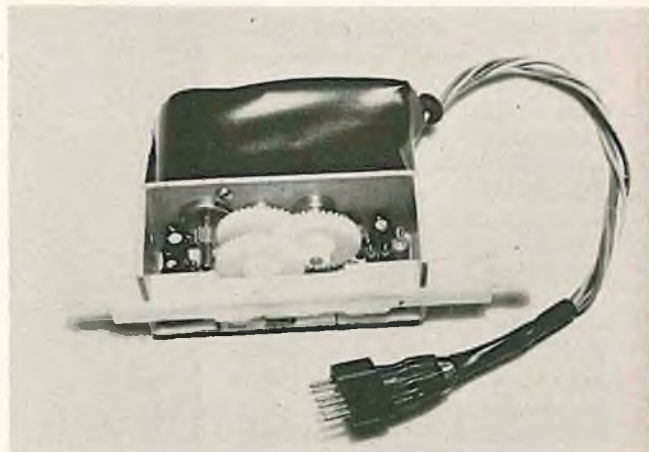

Completed servo less case halves.

points. (Make sure auxiliary board is pushed down flush on main board and at a right angle to it.)

- ( ) Cut 12" pieces of black, orange, red and yellow hook-up wire.
- ( ) Solder them as shown in figure 1 and insert them through hole A in the auxiliary board.
- ( ) Cut 12" pieces of blue and green and a 2 1/2" piece of brown hook-up wire.
- ( ) Solder them as shown in figure 2 and insert them through hole B in the main board.
- ( ) Route the blue and green wires over the top of main board components so they come out at the cutout in the auxiliary board along with the four leads from the auxiliary board.
- ( ) Insert and solder the other end of the brown wire into the vacant hole between Q11 and Q12 (68K ohm lead).
- ( ) Slip a 1/8" grommet over the servo lead wires to hold them in place and out of the way.

NOTE: All wires should be routed between solder mounds. If any wire is routed over a solder mound it will be pressed down by the cover and may cause a "short."

#### FINAL WIRING OF SERVO

- ( ) With completed amplifier on the

C frame make a check for last minute clearances, wiring, etc.

- ( ) Secure the amplifier with the mounting screw and again check for clearances, etc. Make sure the inside .05 motor capacitor doesn't short against any lands on the auxiliary board (see figure 1). Bevel the board if necessary.
- ( ) Solder the blue and red motor leads as shown in figure 1. Leave some "slack" in the wires to prevent breakage by vibration.
- ( ) Bend the wiper arms as shown in figure 3.
- ( ) Put the gears and push/pull arm in place one by one and work the servo by hand (use the second idler gear when fully assembled). Insure that the gears and/or arm do not rub or hit any component. If necessary trim the "knob" slightly on the bottom of the output arm to clear the .001 capacitor.

NOTE: When inserting or removing the output arm be careful the wipers or R10 are not damaged. Jack Port recommends using a thin piece of insulating sheet as a "shoe horn."

- ( ) Check alignment of wiper arms on R10 and brass strip making minor adjustments if necessary. The middle arm is not used and should

"ride" between the brass strip and R10. Tension of wipers will be correct if they extend to bottom edge of P.C. board with output arm in line with C frame slots.

- ( ) Twist the servo leads together and slip a 1" piece of large heat-shrink tubing over them.
- ( ) Cut your leads to desired length (6" is about average).
- ( ) Unravel the end of the leads for about 1".
- ( ) Tin each lead and slip a 1/2" piece of small heat-shrink tubing over each wire.
- ( ) Clean and tin each pin of the connector where you are going to solder.
- ( ) Solder all wires as shown in previous wiring diagram.
- ( ) Slip the heat-shrink tubing in place and heat with a match or by rubbing your soldering iron over it. A match works better but may discolor the wires.

#### FINAL ASSEMBLY OF SERVO

- ( ) Remove output arm and gears.
- ( ) Check overhang on Q12 as per figure 1. It should not extend beyond edge of P.C. board.
- ( ) Bevel areas of P.C. board shown in figures 1 and 2 to provide clearance between copper lands and



cover.

- ( ) Wrap a  $\frac{3}{4}$ " wide piece of black electrical tape around motor and P.C. board as shown in photo. This will give additional protection against accidental contact between case and components, especially Q12's case which is internally connected to its collector lead.
- ( ) Place top cover (with output arm cutouts) in position and adjust until top edge is flush with top edge of C frame. If holes in case and C frame don't line up "carve" away aluminum with an Xacto knife inserted in the cover holes.
- ( ) Tighten the cover in place with two each #2 x  $\frac{3}{8}$ " screws.
- ( ) Insert gears and output arm — check final tension and alignment at this time.
- ( ) Center and cement insulating sheet, provided with servo, to bottom cover with contact glue.
- ( ) Slip on bottom cover and tighten securely with four #2 x  $\frac{3}{8}$ " screws.
- ( ) Check output arm for binding. There should be a slight amount of "play" in all directions when worked by hand. If not adjust the cover. Do not attempt to operate the servo mechanically or gears may be damaged.

- ( ) Save mounting kit for installation.

#### PRELIMINARY CHECKOUT

- ( ) Measure the resistance between the black and green wire (black to black meter lead and green to red meter lead). You should read approximately 1.2K ohms. If you read a "short," check for shorts in the areas pointed out in the article.
  - ( ) If the above reading is normal, and with the meter still connected, squeeze the servo case all over while observing the meter for shorts. If any show up during this check, correct the trouble before proceeding.
  - ( ) Make the same check with the red lead connected to the red meter lead and black to black meter lead. You should read approximately 1.5K ohms and not show a short while squeezing; correct the trouble here also before proceeding.
  - ( ) Run the same check between the black and orange lead. The normal reading is approximately 1.7K ohms.
  - ( ) Run the same check between the black and yellow lead. The normal reading is approximately 1.6K ohms.
- NOTE: While the above tests are not very scientific they may prevent "pranging" an airplane later on.
- ( ) If you have a good understanding of the circuitry you can check

## SERVO PARTS LIST

REFERENCE NUMBER	DESCRIPTION	MANUFACTURER OR SOURCE	MANUFACTURER'S NUMBER
C1	.1 MFD Tantalum	T.I.	SCM104FPO35D2
C2	.05 Disc	Erie	Z5E
C3	"	"	"
C4	2.2 MFD (axial leads)	W.E.	CT 225
C5	"	"	"
C6	.05 Disc	Erie	Z5E
C7	"	"	"
C8	.001 Disc	RMC	SM .001 MF
C9	.01 Disc	CRL	CK 103
D1	Silicon Diode	W.E.	DHD 806
D2	"	"	"
D3	"	"	"
D4	"	"	"
D5	"	"	"
D6	"	"	"
D7	Germanium Diode	Ohmite	1N34 or equiv.
D8	"	"	"
L1	4 uh RFC	W.E.	4 uh RFC
L2	"	"	"
Q1	2N2924	G.E.	2N2924
Q2	"	"	"
Q3	"	"	"
Q4	"	"	"
Q5	"	"	"
Q6	"	"	"
Q7	"	"	"
Q8	"	"	"
Q9	"	"	"
Q10	"	"	"
Q11	GC 4008	T.I.	GC 4008
Q12	"	"	"
R1	22K $\frac{1}{4}$ W	Ohmite	LIDVS
R2	4.7K "	"	"
R3	10K "	"	"
R4	4.7K "	"	"
R5	27K $\frac{1}{4}$ W 5%	"	LID6D
R6	4.7K $\frac{1}{4}$ W	"	LIDSM
R7	4.7K $\frac{1}{4}$ W	"	LIDVS
R8	10K $\frac{1}{4}$ W	"	LIDSM
R9	1.2K $\frac{1}{4}$ W	"	LIDVS
R10	1K Wirewound (Linear)	W.E.	1K SPL
R11	1.2K $\frac{1}{4}$ W	Ohmite	LIDVS
R12	68K $\frac{1}{4}$ W	"	LIDSM
R13	10K $\frac{1}{4}$ W	"	LIDVS
R14	4.7K $\frac{1}{4}$ W	"	LIDSM
R15	4.7K $\frac{1}{4}$ W	"	"
R16	22K "	"	"
R17	" "	"	"
R18	3.3K "	"	"
R19	" "	"	"
R20	100 "	"	"
R21	" "	"	"
R22	" "	"	"
R23	150K "	"	"
R24	" "	"	"
R25	15 "	"	"
R26	" "	"	"
R27	47 "	"	"
R28	10K $\frac{1}{4}$ W	"	LIDVS

#### MISCELLANEOUS — ALL ITEMS AVAILABLE FROM WORLD ENGINES

Servo Mechanism with Cover, Insulating Sheet, Screws and  $\frac{1}{4}$ " Grommet  
 Male Six-Pin Servo Plug  
 Servo Mounting Kit  
 Package Hook-up Wire  
 No. 2 x  $\frac{1}{4}$ " Screw  
 Set P.C. Boards  
 1" Large Heat-Shrink Tubing  
 4" Small Heat-Shrink Tubing  
 Wiper —  $\frac{3}{4}$ " x  $1\frac{1}{4}$ " .006 Brass Stock

For Complete Set of Miscellaneous Items Plus R10 Order DTSM-1.

For Complete Servo Including Electronics Order DTSC-1.

NOTE: Again physical size will limit substitutions. Before you purchase substitute items make sure they will fit; don't buy them on an assumption.



your complete system now. If not (and no local Einsteins are available), spend the rest of the month getting your plane ready.

Next month I'll explain final tuning and testing as well as trouble shooting and preventive maintenance.

NOTE: If you don't know exactly what you're doing or the system is not operating perfectly - wait - don't fly it - you were warned! While waiting you can also recheck all construction for errors, replace all components you substituted hoping they might work (chances are they won't), straighten out all shortcuts you took, etc.; in other words make sure your system is according to the articles. If it is not, please don't tell anyone it's a Digitrio.

Give it another name like "Mickey-Mouse-itrio."

### ADDING COPPER SHIELD TO TRANSMITTER

Some Digitrio transmitters have exhibited RF instability with the antenna retracted or removed. This is due to RF radiation from L5 entering the base circuit of the final amplifiers Q2 and Q3. With the antenna fully extended (assuming resonance) the impedance at the base of the antenna is relatively low and radiated RF voltage of L5 is minimum.

When the antenna is retracted (non-resonant) or removed the impedance rises as does the radiated RF voltage of L5. This can cause regeneration. The solution of course is to reduce the effect of L5's radiation when the antenna is non-resonant or removed. The copper shield described below will accomplish this and is easy to install. I recommend its use even if you are not having this trouble.

- ( ) If your Digitrio is already built remove L5.
- ( ) Cut the shield as shown and clean it thoroughly.
- ( ) Bend it to shape and check for fit.
- ( ) Pre-tin all surfaces to be soldered and solder top joints.
- ( ) Place it in position and solder it to the P.C. board. Use enough heat to allow "wet" solder flow insuring a tight "RF" bond.
- ( ) Drill a  $\frac{1}{16}$ " hole for L5's lead and install L5. Use a piece of small heat shrink tubing over the lead sticking through the shield to prevent shorting.

NOTE: Center L5 in the shield compartment and insure that it does not contact the shield at any point. L5 will have to be moved over slightly toward the antenna mount and a short extension of L5's opposite lead may be necessary if L5 was previously installed. As a further precaution C4 and C5 should be mounted close to and bent over flat against the board to minimize stray RF pickup by their plates.

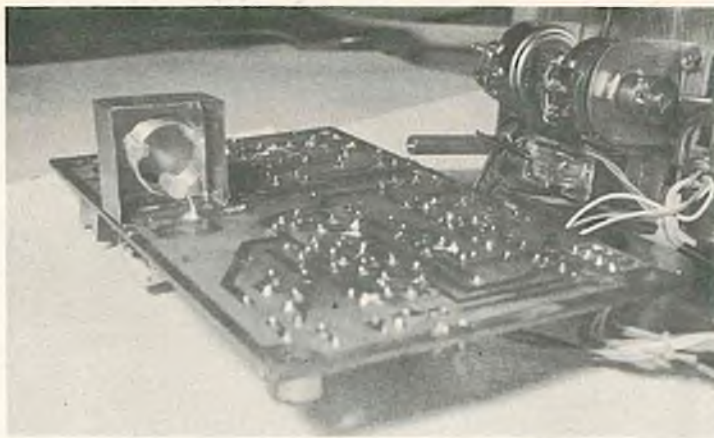

RF shield added to transmitter P.C. board. Below: Pictorial for adding shield.

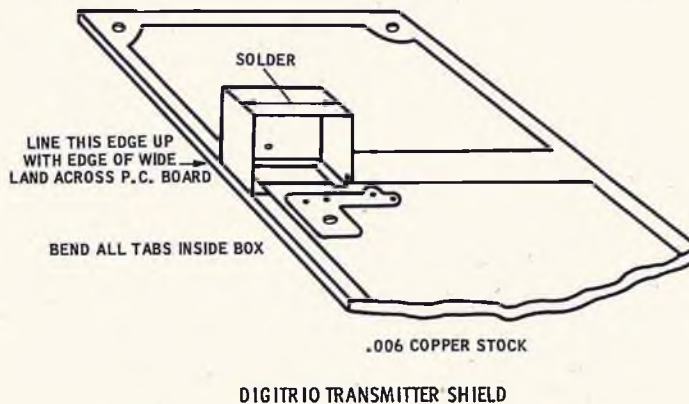

Full size pattern for thin copper RF shield. Below: Ed Thompson's Tauri with Digitrio.

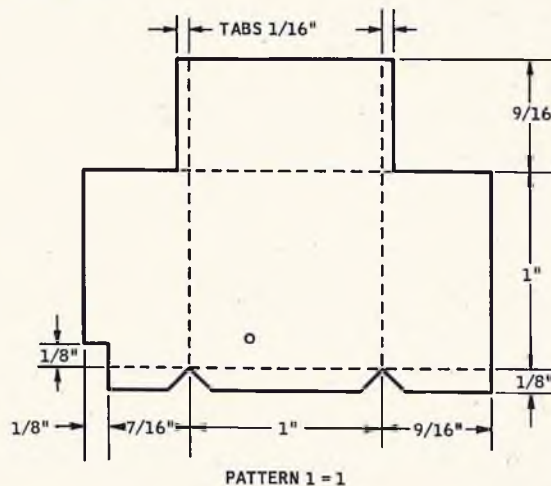



# BUILD YOUR OWN FIBREGLASS FUSELAGES



It's that way with both weather and fiberglass — many people talk about it, but so far, few people have done anything about it. There are many beautiful fiberglass fuselages available on a commercial basis, but not many "home built." That doesn't mean it isn't possible to turn out a superior product in your own workshop, without all the special equipment. In fact, all that's needed to build a fuselage, cowling, or even a boat, is the fiberglass materials, woodworking tools, a large pair of scissors and a ventilating fan.

Fiberglass has many advantages over balsa for an R/C fuselage. With the attrition rate from Sunday flying ("must have been interference") and the lack of time available for building, the speed of reproducing from the master mold easily solves the time problem.

In watching some of the more experienced contest fliers, I have noticed that they stick with a good design and with modifications, may build 5 or 10 prototypes, sometimes 2 or 3 concurrently (just in case!). The ready duplication from a fiberglass mold makes this practical. It proved to be so easy and fast — and just plain fun — that I didn't stop until I had a half dozen

completed. Another advantage that appealed to me was the beautiful compound curves obtainable. They can be achieved quite effortlessly and without adding the weight which can't be avoided in built-up, balsa block structures. These curves also serve to give the fuselage rigidity and strength. This last factor — the strength of fiberglass — has been recognized for quite some time in model building. For example, fiberglass has been used for reinforcing the front end of balsa fuselages for several years.

If you can obtain any shape you want in fiberglass, why not one that looks like the real thing? The Hawker Tempest, illustrated here, was selected because of its pleasing appearance, and similarity in aerodynamic configuration to successful multi aircraft. The method described, however, would suit any aircraft. The detailed construction information is followed by a summary.

## Construction

The fashioning of the male mold or "plug" will require your most careful attention — your final product can't be much better than this original.

The object is to make both halves of the fuselage at the same time and in

one piece, but in such a way that they can be separated into equal halves. This was accomplished with dowels as illustrated in photograph 1.

Two clear pine planks were dowelled together after cutting the basic shape (top and side views) with a band saw. (Sort of reminds you of the old solid balsa models, doesn't it?) Wing fillets were individual blocks of pine, white-glued into position before carving. Carving was done in the rough with a chisel, then long sweeps with a plane, followed by a disc and drum sander in a  $\frac{1}{4}$  inch power drill applied to the curved areas. Incidentally, if you have a lumber yard that sells imported wood, it may be possible to get large blocks of balsa to use instead of pine. The balsa can always be re-used later for another project.

Final sanding should be done with a sanding block to prevent a raised grain. Then Hobby Pox "Stuff" should be thinned to paint consistency and brushed on. Block sand between coats. When the wood grain is completely filled, mount each half on a  $\frac{1}{2}$  inch plywood plank by screwing them on from the back. (See photograph 2.)

(Continued on Page 55)



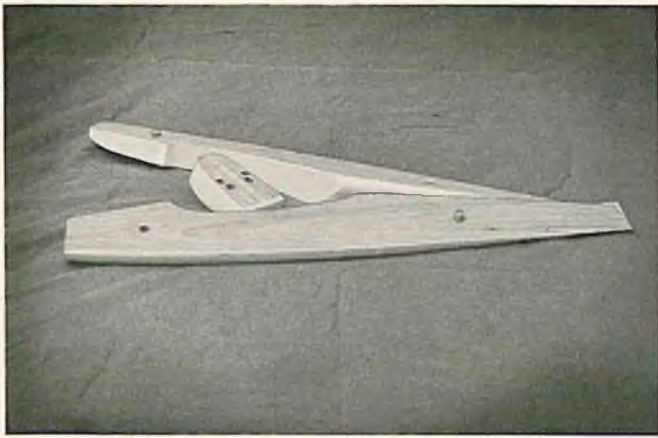

The carved "plugs" showing the dowels joining the 2 halves as a single unit while shaping. The chin radiator was also doweled under the nose to assure that the curves flowed between the three units.

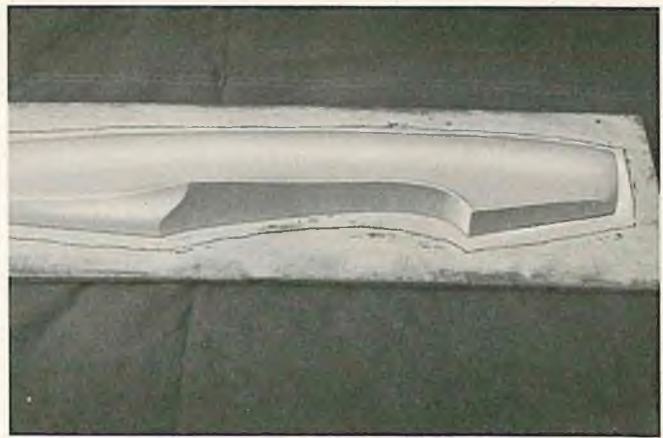

The "plug" was screwed to a plywood plank. The line drawn on the plank outlines where the female mold should be trimmed to provide a flange. The flange on the female mold serves to screw it down to the supporting frame shown in the next photo.

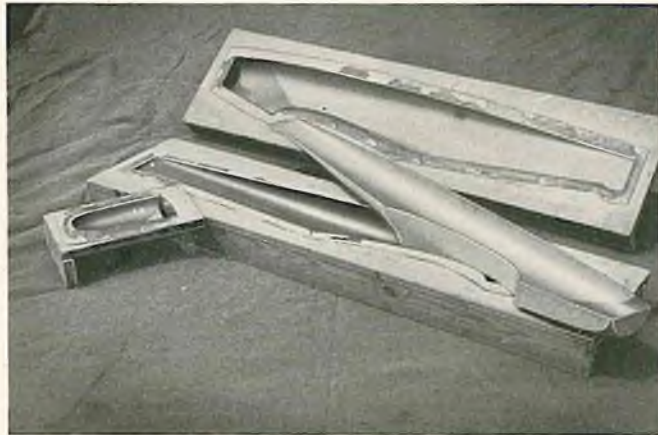

The top mold has a finished fuselage half, yet to be released. The reinforced nose section can be seen. The lower fuselage mold has been released and the fuselage half is setting free. The small mold contains a chin radiator dowel.

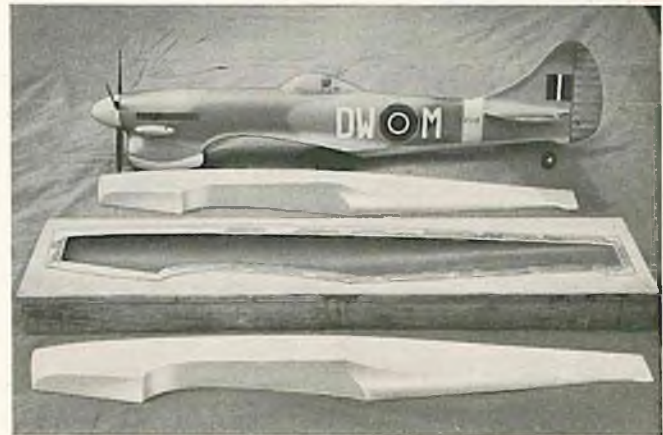

The 4 stages: Bottom, the carved "plug." The female mold in its frame. A finished fiberglass shell before joining. Top: The joined and finished "Tempest" fuselage.





# REGATTA

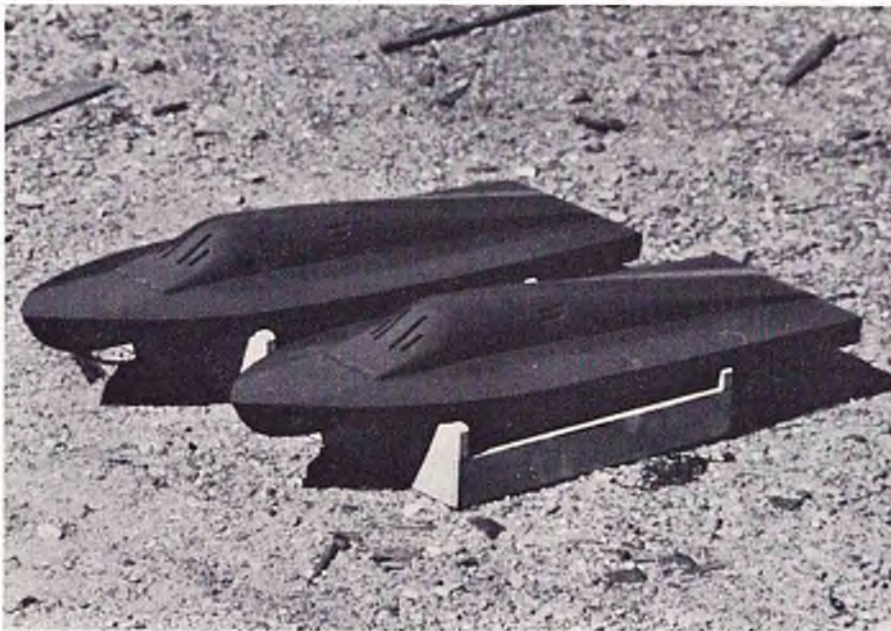

Two Rossi .60 boats by Holger Schweizer and Helmut Renninger.

**F**ROM Holger Schweizer, 7 Stuttgart-Mohringen, Anne Frank-Weg 1c West Germany came a special report on boating activities in Germany. There are three major classes of combustion engines — Class F1 V 3,5 for 21 cu. in.; Class F1 V 10 for .60 cu. in.; and Class F1 V 30 for 1.80 cu. in. The first two categories are the most widely used events, with the V 30 being the special class of England, due to the big Gannet OHV and 15 ccm glow engines. These larger mills are built into big runabouts, similar in design to the “Cobra,” popular in the U. S.

The three point hydro, widely used in the United States, is not popular in Germany. Their popular favorite is a round bottom hull with average measurements of 28" x 12½". This class is powered by either .5 or 10 cc engines. All European record trials are run with this combination of hull and motor.

The speedway, or course, used by the German boatmen is a triangle, per

the drawings. Each leg is 100 feet long. After driving the course, a 180 degree turn is made, and then a return run. The fastest time to date was driven by Kurt Matschulat with 27 seconds for the 3,5 and 22 seconds in the 10 ccm class. The triangle shaped course requires fast and precise throttling, with straightaway speeds in the 40-50 kilometer range for the 3,5 boats and 60-70 kilometers per hour for the larger 10 ccm boats.

In a future report, Holger will give details of certain specialized items, such as hulls, engines, props, radio gear, etc. Interested U. S. boatmen are invited to correspond with the author directly for exchanging information on both internal combustion and electric powered R/C craft.

A blast of the starting horn and a wave of the green flag marked the beginning of the DeVry Dolphins first IMPBA regatta. The day was Sunday,

September 19, and the site was Potawatomi Lake, Wheeling, Illinois.

It was the Dolphins first regatta, and it turned out to be one of the best of the season. Bob Pachman, Dolphin Commodore, loaned the club all of his experience gained in full-scale boat racing in order to help make the regatta a huge success. There was never just one boat on the course — but, in most cases, anywhere from two to five, all running at the same time. Even movies can't do justice to the excitement brought on by this kind of R/C boat racing — you just have to be there to really feel the thrill and excitement in the air.

Each race consisted of four laps, or one-half mile. The race began after all boats were in the water, circling to the right of the starting line, and after the one minute clock time had elapsed. The starting horn blasted, the starter waved the green flag, and the race was on.

The first race of the Regatta was between five boats, all in the .20-.29 engine class. Three minutes were allowed for starting engines, and in that three minutes time, and the sixty seconds before the horn sounded, two boats were already out of the race. A third soon followed, and only two boats were still running when the white flag was waved to signify one more lap. Randy Peterson with his Hornet was the eventual winner, and the only one of five to complete the required four laps.

In the .45-.65 engine class Ron Buck of the Minute Breakers came in first with his White Heat 60-Rossi combination over Jack Peterson of Downers Grove, Illinois and Larry Atkinson of Beloit, Wisconsin.

As there were ten entries for the “F” class engine, they were broken up into groups of four, four and two. At the beginning of the last two laps, Donn Jordan with a fiberglass White Heat and Marianne Preusse with a fiberglass Cobra were running just about even when Donn's boat stopped “dead” in the water. With a clear field and only three-quarters of a lap to go Marianne ran her Cobra into Donn's White Heat and she too was out of the race. Further inspection showed only minor scratches on the paint of Donn's boat while Marianne's had a broken strut, missing propeller and bent shaft to put her out of commission for the rest of the day. Donn later placed second in this event.

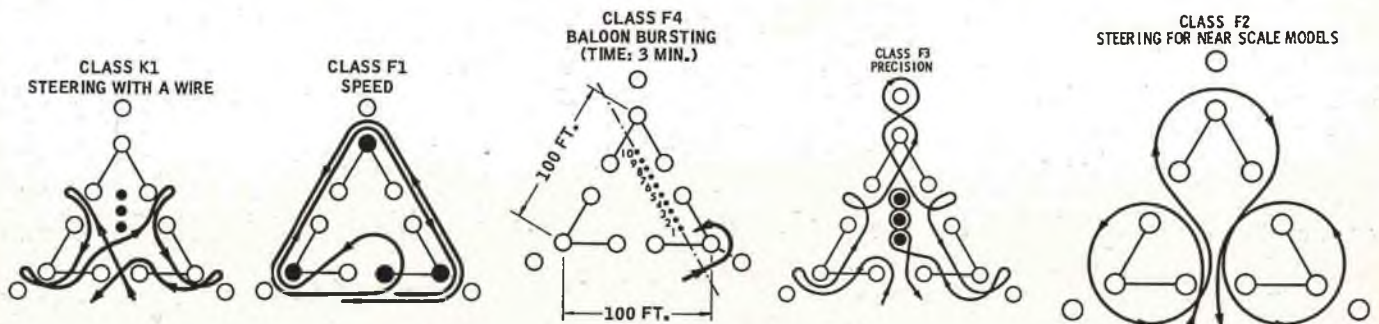



In the second race between boats in the "F" class, Mert Mischnick placed first with his orange and white Trident. It was during this race that Gene Milasius steered into the idle boat of a fellow club member, Ronald Piencak. Ron's boat was a beautifully finished run-about hull so you can imagine the extensive damage a hydro can do to a boat like that at full bore!

In the Sr. Sweepstakes Jack Peterson with his Tigre powered Challenger II skipped ahead of Donn Jordan and Mert Mischnick for a well-deserved first. This isn't the first time that Jack and Randy Peterson have gone home with first place trophies.

Multiple racing four and five boats at a time is growing in interest rapidly here in the Midwest. Even the "new-comers" who never ran with anyone else are trying their hand at it and finding it much more exciting than running "solo." Not every contest features multiple-boat racing, but a good many of them do. The I.M.P.B.A. and many of its members here in the Midwest continues to experiment with new and better ways of running this type of regatta in the hope that they will be able to come up with a definite set of rules for all I.M.P.B.A. multiple boat racing regattas.

**YOUR** boating activities, designs, and projects are welcomed by R.C.M. Address:

Regatta Editor, R/C Modeler Magazine, P. O. Box 487  
Sierra Madre, Calif.

Jim Whitlatch, reporting from the West Coast, mentions that practically all of the R/C boat clubs in California belong to W.A.M. This enables the western clubs to obtain insurance, contest sanctions, and establish W.A.M. records for  $\frac{1}{16}$  mile straightaway and/or  $\frac{1}{4}$  mile oval. Two hull classes are available, hydro or monoplane, and in several engine classes within the two categories. This is quite similar to the I.M.P.B.A. Once a year the "Council," or organization of W.A.M. boat clubs, sponsors a two day meet held in Delano, Calif. This is probably the best R/C boat site in the state, and being only thirty miles north of Bakersfield, it is centrally located for the benefit of boatmen throughout the state.

This year, there were approximately 60 boats at the meet, entrants coming from San Diego, Los Angeles, Bakersfield, Santa Maria, San Francisco, Sacramento, and various points in between. Gas Precision, Three Lap Speed, Speed Obstacle, and Multiple Boat Racing events were held. Engine classes were Class A (.00 to .40), Class B (over .40).



Lewis A. "Steve" Stevens with scale SK boat. Original design twin .60.



Twin .60 uses steel con rods, ball bearing mounted, original design diaphragm carb. 15,000 R.P.M. alternate firing.



Joe Barazota of San Francisco with Mc-Coy .60 hydro. Plans on twin .60.



Modelers Jack Krohn and Steve Much with original ski hull and gas precision shrimp boat.



San Francisco's Frank Snowden with a twin .60 ski boat. Engine by Dick Tyler.



Roger Norsikian with one of his beautiful Norco Cruisers, built of course, from Roger's Norco kit!



L. to r.: Carl Offerman, Bob Foley, Lou Staples at Timers table. Note bull horn and electronic timer.



Jim Whitlatch's Ski at speed. Note multi boat racing starting clock — same as used for full-sized craft.



# RCM TECHNICAL BREAKTHROUGH!

## THE DIGITAL DECABULATOR

An Inverse Reactive Current Servo  
Developed By The RCM Technical Staff

*It seems as though many breakthroughs are being made in our hobby. As proof of this look through the last several months copies of the different model magazines. Everything from the kicking duck to pulsed reeds are described as breakthroughs even though some of the items were conceived as far back as "Air Trails."*

*We at RCM are embarrassed that we haven't come up with a breakthrough of equal magnitude and would like to offer this article to show how much we are concerned. We feel that this article is equal to or exceeds any breakthrough published in the model press over the last decade, and is our official breakthrough for 1966.*

FOR a number of years, work has been proceeding in order to bring perfection to the crudely conceived idea of a servo that would not only supply inverse reactive current for use in unilateral phase detractors, but would also be capable of automatically synchronizing cardinal grammeters. Such a servo is the "Digital-Decabulator." Basically, the only new principle involved is that instead of relying upon

hydrostatic activation of the negative control mechanism the machine has a magnetic amplifier thrust action.

The original machine had a base plate of prefabricated amuline, surmounted by a malleable logarithmic casing in such a way that the two spurving bearings were in a direct line with the pentametric gear. The ambifascient lunar waneshaft was supported so that side fumbling was effectively prevented. The main winding was of the normal lotus-o-delta type, placed in panendemic semi-boloid slots in the stator, every seventh conductor being connected by a nonreversible tremie pipe to the differential girdle spring on the "up" end of the grammeters.

Forty-one manestically spaced grouting brushes were arranged to feed into the rotor slip-stream a mixture of high S-value phenylhydrobenzamine and 5% remenerative tetryliodohexamine. Both of these liquids have a specific pericosities given by  $P \ 2.5C \ 6.7$ , where P is the diathetical evolute of retrograde temperature phase disposition and C is Cholomondeley's annular grillage coefficient. Initially N was measured with the aid of a metapholar refractive pilfrometer (for a description of this in-

genious instrument, see L. E. Rempelverstein in "Zeischrift for Elektrotechnistatichs-Donnerblitze," Vol. v11), but up to the present date nothing has been found to equal the transcendental hopper dadoscope.

Electrical engineers will appreciate the difficulty of nubing together a re-gurgitive pruwell and a supremitive wennel-sprocket. Indeed, this proved to be a stumbling block to further development until, recently, it was found that the use of anhydrous nagling pins enabled a kryptonastic bolling shim to be tankered.

The early attempt to construct a sufficiently robust spiral decommutator failed largely because of a lack of appreciation of the large quasi-iestic stresses in the gramlon studs. The latter were specifically designed to hold the roffit bars to the span-shaft. However, when it was discovered that wending could be prevented by a simple addition to the living sockets, almost perfect running was secured.

The operating point is maintained as near as possible to the h.f. rem peak by constantly fromaging the bitumogenous spandrels. This is a distinct advance over the standard nivel-sheave in that no dram-cock oil is required after the phase detractors have remissed.

Undoubtedly the Digital-Decabulator has now reached a very high level in technical development. It has been successfully used for operating noffer trunnions (similar to ailerons). In addition, whenever a varescent skor motion is required it may be employed in conjunction with a drawn reciprocating dingle arm to reduce sinusoidal depletion.

Of course some work is still necessary before it can be manufactured but the advanced technician should find this article invaluable as reference material. One word of caution! BEFORE STARTING WORK ON THE SERVO BE SURE YOU FULLY UNDERSTAND ITS OPERATION!



"Oops!"



"I forgot to switch on the what?" (Dedicated to Ralph Brooke)



# NATIONAL MINIATURE PYLON RACING ASSOCIATION

P. O. Box 487 • Sierra Madre • Calif.



Goodyear pylon offers the supreme challenge to the racing pilot, the ultimate in spectator enjoyment.

**T**HIS month, the N.M.P.R.A. column will be brief, due to the special report by Hal deBolt in the last issue concerning the Goodyear event. There is a great deal of merit to Hal's article, and we urge each and every RC'er N.M.P.R.A. member or not, who is interested in the Goodyear pylon event, to express his opinions and suggestions based on the comments in that article. From the beginning, the N.M.P.R.A. was established to provide an event that would re-create all of the excitement of full-scale air-racing, yet designed so that every RC'er would have an opportunity to participate — not just the expert flier category. This is **your**

event — don't let it get away from you now. Your comments and suggestions, and your voting membership in the N.M.P.R.A. will assure the ultimate success of this event for everyone concerned.

Along this same line of thinking was a recent contest held September 19th in Lakewood, N. Y., and hosted by the Flying Aces. This meet featured the Goodyear Pylon event, but in order to give everyone an opportunity to fly, Robert "Doc" Gulvin, CD, scheduled two other events — Open Pylon and Cabin Type Pylon. Perhaps some of the statistics will be of value and in-

terest to other Contest Directors in their planning for future events.

Forty-six entrants paid \$5 each to enter the Flying Aces one day affair. Ninety percent of the contestants had never before flown in a pylon race, yet competed three at a time, in the three events. Entrants were permitted to enter all three categories with as many planes as the individual elected to use. The three contest categories gave variety to the meet, along with a change of pace from the usual speed machines. Although not an N.M.P.R.A. event, the Cabin Type Pylon saw such entrants as two deBolt Champions and a Trainer in the same race — flying much slower than the usual Goodyear ships, and giving the newcomer to competitive flying a chance to decide whether or not he would like the Goodyear event. As it turned out, these flyers will all be Goodyear entrants next year!

The main objective of the Flying Aces in conducting this meet was to get as many flights in as possible. As a result, there were three planes on the starting line while each race was in progress, with three additional planes in the pits directly behind the starting line. Records shown that between 9:00 A.M. and 4:00 P.M., 160 flights were called! Only one mid-air collision occurred, that being caused by a hand launch directly in the path of another plane. One plane was damaged, the other re-started his motor and flew in the subsequent race.

General statistics for the event included records for 46 entrants with 79 planes on the field to fly. Of the latter, fifteen were Goodyear participants. The Goodyear Perpetual Trophy was sponsored by Marlin Rockwell Corporation and won by William Dart of Lakewood, N. Y. with a time of 3:08 minutes. The Grand Prize and Orbit 3+1, was won by Thom Griebm of Jamestown, N. Y. Spectator interest was high with approximately 1000 persons attending.

It is quite possible that this type of meet is hatching a new breed of flyers

*(Continued on Page 58)*

R. Van De Walker of Norwalk, Calif., with his "Johnny Reb."

Spectators experience the same thrills as in full-scale racing with the added "plus" of identifying with model aviation.





# KITS AND PIECES



**T**HIS month's column will undoubtedly cause a few raised eyebrows among a few of our readers and possibly amongst the R/C kit industry.

We had heard via the vast R/C grapevine (probably unequaled even in the underworld) of a new kit being produced — Phil Kraft's Kwik-Fli Mk II, the fantastic contest winning machine that was featured in RCM a few months ago. The claims concerning the kit were unbelievable at best. We had to have one!

After considerable searching, the manufacturer and distributor was located, the former being Jensen Enterprises, P. O. Box 214, Glendora, California, and the latter NEMO Hobby Distributors, 4720 Peck Road, El Monte, California, and our order was placed.

The Kwik Fli arrived about two weeks later. The box was almost destroyed in our eagerness to "get at" the contents. The parts were immediately spread out on the kitchen table. It is said that "seeing is believing" — not anymore! The finished parts that came out of that box were **unbelievable!** Several of the better local craftsmen were called in to have a look — either to confirm this opinion, or to confirm the fact that I had been brainwashed by the boys out West. They unanimously agreed that they had never seen balsa pieces like these! Every part appeared to be, well . . . beyond words. There was not one diecut part. Instead, each piece appeared to have been individu-

ally machined to finished shape from the most beautiful balsa that I have ever seen. More about this later.

According to the instruction book, the first days' work was the construction of the stabilizer, the rudder, and the left-hand section of the wing. So be it. The stab is sheeted framework construction. The two bottom sheets were butt glued together (a perfect fit). The trailing edge spar, the leading edge spars, the tips and center doublers were then glued to the bottom sheet. Each of these pieces was pre-cut to **exact** shape and length and required **no** trimming whatever to mate flush around the perimeter of the bottom sheet! Now came the supreme test — the diagonal ribs. These were placed in the framework, working from each end toward the center — and that's exactly where they met. These diagonal ribs were not only cut to length, they were also pre-beveled! The top sheeting was added, and the entire structure weighted to assure flatness.

Rudder construction amounted to no more than gluing the main fin to the dorsal fin, again, a perfect match, both parts having straight and square mating surfaces.

We were somewhat wary of the wing construction, since the plans call for a "lapped" spar joint at the center section, although a butt joint could have been used. Each spar had been tapered to a thin edge at one end, and it seemed a shame that this much effort had been put into this extensive bit of work by

Jensen Enterprises. The spars were laid out in their proper mating order, per the plans, and the left panel spars were selected and oriented.

Construction of the panel was begun by laying the top trailing edge sheet on the plans. The inside of the sheeting is pre-beveled to match the rib shape at the trailing edge! Warning — this wing is built **top down** over the plans. The rear spar and spar doublers are glued to the sheeting, using caution to position the spars exactly as indicated. The front spar and its doubler are blocked up  $\frac{1}{16}$ " and the ribs glued into position — **upside down!** The bottom spars and doublers are then glued into place, followed by the leading edge of the ailerons, which are built as part of the wing and then cut out. The front sheeting (pre-beveled and marked), landing gear mount, and rear sheeting are now glued into place. The pre-cut capstrips (that's right, pre-cut) complete the basic framework, which is now allowed to dry thoroughly. Actually, the capstrips had to be trimmed about  $\frac{1}{16}$ ", and this was our first encounter with a knife!

The following evening, the right-hand wing panel was constructed, following the same procedure as for the left hand panel. The fuselage was built using the  $\frac{3}{8}$ " top sheet as a building base. Triangular longerons are glued into place on the top sheet (the longerons are notched for servo rails and tapered at the rear). The bulkheads are now glued into place, along with the servo rails

RCM Digitrio with Bonner stick assembly. Over 50 flawless flights to date.

Servo switching mechanism used in last month's Regatta One sailboat.

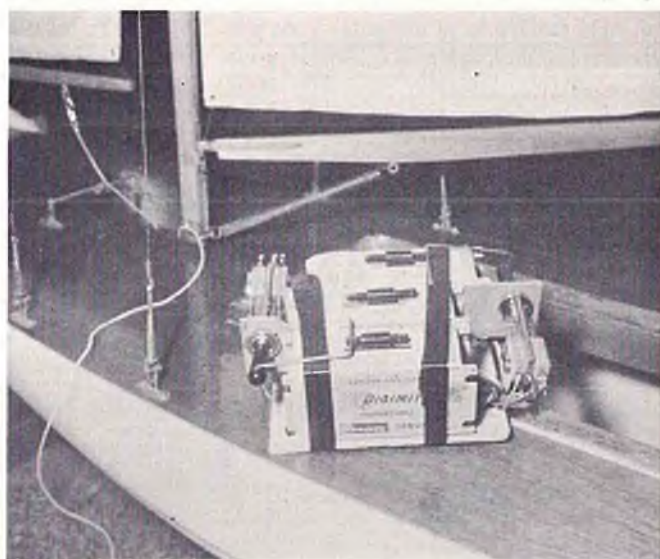





Kwik Fli Kit parts out of box.



Closeup of some finely finished parts.



Basic stab construction.



Assembling wing ribs, spars, and T.E.



L.E. and aileron ribs added.



L.E. sheeting secured. T.E. in place.

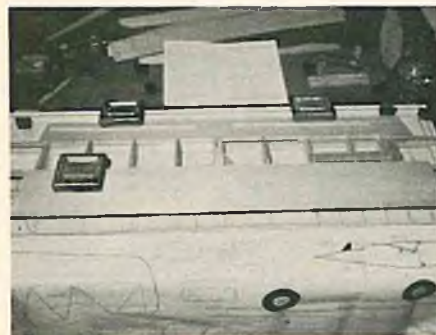

L.E. planking glued to spar.



Center section added to complete panel.



Longerons and bulkheads glued to top sheet.



Adding the sides.



Doublers and portion of rear stringers added.



Fuselage bottom sheet added.



Epoxying fire wall in place.

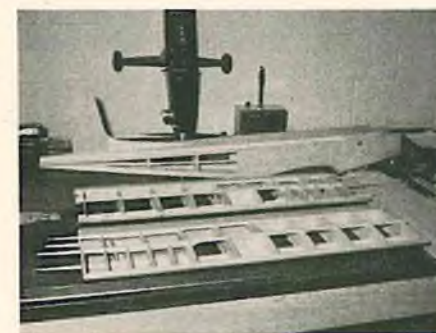

All basic assemblies.

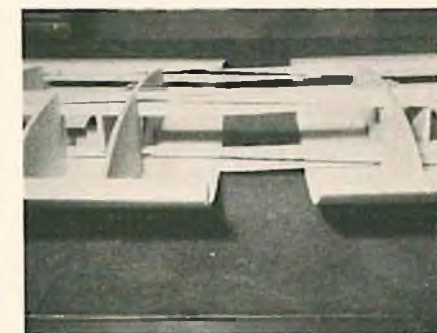

Lapped spar wing joint.



and pushrod guides for throttle and steering. The fuselage sides are glued into place along with the side doublers. The instructions call for the stabilizer to be installed at this point, with the rest of the fuselage built around it. We temporarily installed a dummy stab in order to get the proper opening, leaving the actual assembly until later. The fuselage stringers and bottom longerons were then put in place. Each of these terminate at an angle to the stab, and each was pre-cut — not only to proper length, but also to the exact and correct angle! The rear bottom fuselage sheet was glued into place, and the firewall epoxied in position. A piece of ¼" scrap is required at the leading edge of the stabilizer. Believe me when I tell you that the only scrap is the trimmings from the outboard ends of the wing spars!

At this point, all of the basic construction had been completed and our knife had been rarely used. Everything had fit together unbelievably well — still, we wondered about the wing spars.

The following morning, Saturday, the right wing panel was removed from the

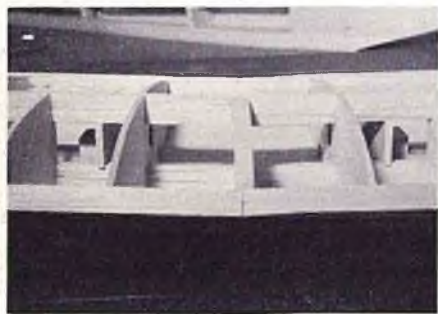

Assembled "Lapped joint"

Magna Jig, ready for joining the panels together. Try to visualize sixteen assorted tapered spars and doublers, all of which are supposed to interlace, forming a joint stronger than a single piece. Carefully, the two halves were brought together, positioning each piece in its proper place. Slowly the joint was slid closed until the sheeting on the two sections met. Not only did the "lapped joint" spar assembly fit, it also positioned the panels at the proper dihedral angle! Epoxy glue was used to make this joint, since white glue has a tendency to "grab" when sliding into a tight fit.

Only after the epoxy had cured did we discover that the aileron servo mounting rails should have been installed when joining the two wing halves. Don't make the same mistake! The remaining wing sheeting was added, and the entire wing sanded before cutting out the "built-in" ailerons.

All that remains, now, is sanding, covering and doping. Total time for construction was two evenings and a Saturday!

If we sound overly enthusiastic about Jensen's Kwik-Fli, it is only because we are! Here is a contest multi ship that is entirely built-up (meaning no foam or fibreglass), that builds as quickly, and in many cases more easily, than the ultra-prefab "almost ready-to-fly." Assembly and fit are as good, and in most cases even better, than one of those fabulous plastic kits of Junior's. Wood is "quadruple A," if such a thing exists, and the cutting is so clean that I am at a loss as to how it has been cut. All edges are straight and true, and, where required, beveled to the proper angle to assure a perfect fit. All of the glue joints should be unusually strong, since they are all wood to wood, and not merely a near fit with a glue fillet. In addition, the Kwik-Fli kit includes an unusually complete hardware set. Aileron bellcranks and horns, rudder and elevator horns, complete nose gear with special steering arm, bolts, nuts, washers, a molded canopy, and even Williams Brothers nylon clevises are all included. About the only things not included are covering materials, glue, and wheels!



Kwik Fli II

"how do I operate the controls from my system?" Our solution turned out to be very simple. The F&M proportional system had been installed in a Top Flite "Tauri," with three servos mounted side by side. The servo board was pulled out intact, and mounted in the boat. Two pieces of plywood were cut and slid between the servos, one extending out each end. This whole mess was then securely taped together. A lever switch (the type used on read transmitters) was mounted on each piece of plywood and actuated by the servo. Each switch controls one of the sail drive motors. The third servo operates the rudder. This type of installation will work with any type equipment, reeds or proportional. Sailing has turned out to be quite a ball, having logged over ten hours to date. Sometimes I think the spectator reaction is the best part — they just can't seem to understand it. . . .

We test flew our RCM Digitrio proportional system in a tired old "Tauri," and to everyone's complete satisfaction. This may sound like a plug for RCM



Ready for covering

Jensen Enterprises is a small outfit, not capable of large scale mass production of kits. Estimated delivery time is one to three weeks, each kit being carefully and individually assembled. Many dealers throughout the country will be stocking the Kwik-Fli, distributed to them through NEMO. We do not mean to imply that the average mass-produced kit by the leading kit manufacturers should be compared to the Kwik-Fli, since manufacturing techniques presently required to turn out large quantities of a kit do not permit the "Tender Loving Care" so apparent in the Kwik-Fli. We would suggest, however, that other kit manufacturers obtain one of these kits for their own evaluation and edification. Better kits, in many cases, could regain sales lost to foam and fibreglass!

There you have it — the Kwik-Fli Mk II by Jensen Enterprises — \$34.95 and a real winner!

I have one local "taker" on my sailboat race challenge to date. The big problem with sailboats seems to be

(it is), but we have built two Digitrios (Digitrii?) without a hitch. The one test flown will stand up with the best as far as range and servo resolution (ability to track accurately) are concerned. With only four flights, we would be foolish to comment on interference or reliability, although bench test and experience indicate that both should be excellent. Note that we are using a Bonner stick assembly on ours, with throttle control on the top of the can.

AAMCO has announced the release of their Aeromaster biplane. This is the ship that was the hit of the DCRC Symposium and also the recent Nationals. The Aeromaster has a span of 48" with an area of 817 squares, and designed for either sport flying on six channels, or all-out free style aerobatics on full house. We will be building this one. Available about January 25 at your dealer. Price will be \$34.95.

Meanwhile, back at the office, our  
(Continued on Page 52)



# CUNNINGHAM ON R/C



**T**HERE is an old saying that goes — “You don’t get something for nothing.” This is nowhere more true than in the pursuit of our hobby of radio control. You can, however, get something **more** for just a very little effort and use of imagination. Every issue of this, and other model magazines, usually carries several ideas or thoughts on how to make a given idea work, or how to accomplish a given task by an easier method.

Actually, the purpose of this article is not to present too many new ideas, but to encourage you to think of some new applications for existing ideas. The “something for nothing” portion is simply that with a little use of brain power you can get a lot more out of your radio gear than it was originally intended to give. Not in range, or in transmitter power, but in the use and application of servos.

Most of the modelers who have grown up through pulse rudder and galloping ghost have had to try their hands at many types of gadgets. This was simply due to the fact that there were very few servos on the market for this type of operation, and those that are sold are generally an extension of an individual modeler’s solution to his particular problem. But, in the simple proportional setup, you must be an inventor and tinkerer of sorts, and as such, you generally come through this phase better equipped to tackle unusual circumstances in multi work.

The best modus operandi for tackling a given problem is to first identify the problem, and then set about in a systematic way to solve it. Problems such as how to make a simple engine control for pulse rudder or galloping ghost, or rigging a bomb drop, or how to couple ailerons to rudder, or how to make a simple retractable landing gear are but a few of the ideas to consider. It is easy to take the receiver and servos from the box, screw the servos to a board, fasten this in the aircraft, then

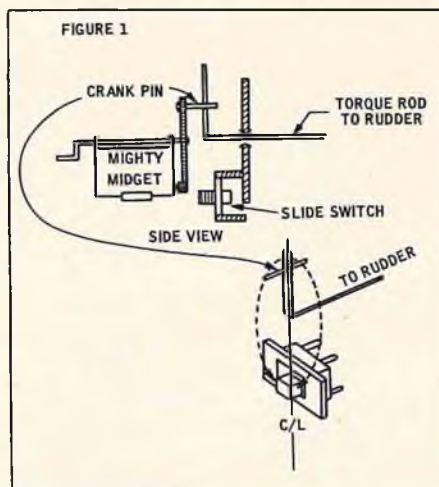

plug in the batteries — simple, almost foolproof — and, let’s face it, just about all that ninety percent of the RC’ers want to do. But, for you other ten percent that would really like to have something a little different, the following ideas are presented.

A simple method for rigging engine control for pulse rudder was a very momentous problem to me some time ago. Pulse omission detectors and pulse rate detectors were just making their way into the language of the RC’er, but a simpler solution was tried — and it worked! Pulse has long since been abandoned as the major interest in RC, but the idea is still good and may be adopted by you for some other use.

A slide switch was used with a separate battery source to operate an SN escapement hooked to the throttle. The switch was taken apart, the spring removed, and then the switch mounted in the ship in such a manner that the rotating crank of the Mighty Midget motor would flip the switch in one direction for high engine and another for low. The switch further served the purpose of acting as a limit stop for the crank. The system was simple, and yet worked reasonably well. A refinement of this was published some time ago in

RCM which used a kickup elevator with pulse rudder. This proved much easier to hook up and use than galloping ghost systems and did approximately the same job — in some ways better.

Moving on to multi work, ten channels of control seem just about all that the normal modeler could, or should want, and if you omit the ten thousand variations on a Bonner Digimite, the only system that offers you more is a twelve channel rig. If you have a six channel system, or a ten channel receiver and transmitter, and wish to obtain more control functions, then you have to use the old ingenuity. You can duplicate a ten channel setup by mechanically coupling several operations into one.

For example, if you want to have a trim function, but have only six or eight channels, then the easiest way to do this is to tie in the trim elevator function to the throttle control. True, it isn’t quite the same as flying with a pure trim control, but the primary use of trim is to change the flying character of your ship at low and high speeds. Therefore, if you wish to keep the nose of your ship down at high speed, rather than climb out at high throttle, tie the engine speed servo to the elevator servo with a system similar to a DuBro in-line trim bar. Any other will work, but this will do a fine job. Tie the engine and trim together so that the setting for high engine will give you a down trim setting, and a low throttle will give you an up trim setting. Getting just the right amount is a matter of trial and error, much like learning just what the right amount of trim is satisfactory when using a trim servo. The illustration also pictures a variation of this that can be used with a smaller ship flying on only four channels with elevator trim tied in, or the same system can be used in place of the in-line type trim bar.

Next, the ailerons can be tied into the rudder servo. This idea has been advanced many times before, and we are not going to present another method, but rather, delve into the basic idea behind this feature and then let you use the idea itself for anything you may wish. The illustration shows the correct way of analyzing your setup in order to

(Continued on Page 51)

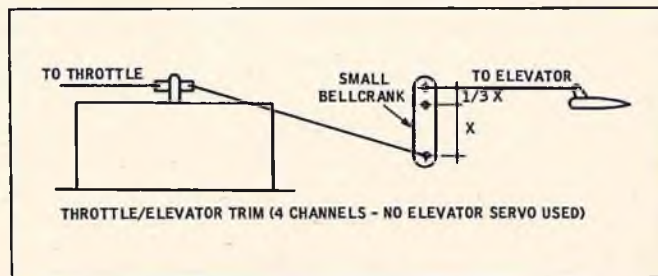
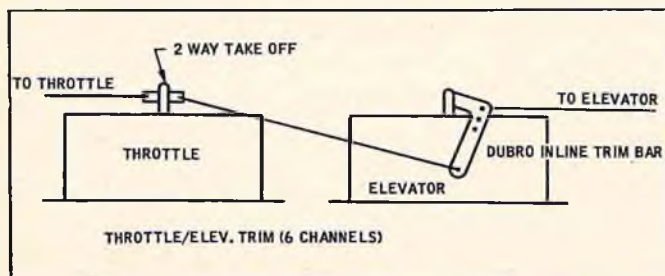



# TOP OUT

BY JERRY KLEINBURG



Five champs from the four corners of the U. S. who competed in the Tournament of Champions held in Oklahoma City. Cliff Weirick on the left gets the attention of DeBolt, Brooke, Kraft, and Kirkland during a moment between rounds. Cliff holds their attention when he's flying, too. He won Goodyear Pylon to repeat his Nationals win in that event.

## INVISIBLE FLIERS

**J**ACKIE GARDNER, 1965 Nats Class I winner writes that he feels the rudder class is not developing at its full potential because it is not receiving a reasonable share of attention in the modeling press. He believes participation and general development is being hampered by an artificial vacuum due to a lack of coverage. As a consequence, he concludes, growth toward an FAI activity and better Nats performance for rudder fans is delayed and that this in turn is detrimental to RC in general.

Since other voices have also indicated similar dissatisfaction a survey of coverage of class I Nats action as reported in all other modeling media was made to test the validity of the complaint. It was reasoned that since the Nats is covered by all magazines in considerable detail examination of reportage rendered the no. 1 modeling event would provide some indications or proof of the contention. The results were so conclusive that it's almost anti-climactic to repeat them here! However, for those who are curious here are the statistics:

Of a total of 153½ column-inches of written material in all media 4½ inches (2.7%) were devoted to class I. In pictures, only 3 of 86 (3.4%) showed rudder activity. Considering picture space it was found that of 826 square inches presented, 34 square inches (4.1%) dealt with class I subjects. Give or take a little, it amounts to 3.3% of space and coverage given to RC for the 1965 Nats.

Breakdowns were interesting with a major monthly providing only a microscopic 3 lines (60 column-inches deep) in their 73 column-inch (693 lines) coverage while devoting 2 of 48 pics to RO. A bi-monthly did better by giving 4 column-inches of description to class I matters out of a total of 78 inches. Another bi-monthly that limited Nats coverage to photos devoted 143 square inches to RC, gave none to class I! Even the AMA magazine ignored rudderites completely in their 2½ column-inch 'technical' coverage of RC at Willow Grove.

Since these figures pretty well speak for themselves further comment is just about unnecessary. With the rapid growth of RC it is believed all segments of the hobby/sport may grow and that

this is possible without detracting from any segment or at its expense. Therefore partisanship, if indeed this is the underlying cause of the poor coverage, is somewhat misplaced. More than likely however, the indifferent reporting is an oversight. Since model magazines tend to give their customers what the customer wants a post card expressing those desires to the modeling editors should awake them to the obvious void and should prompt action to bring about balance. In the meantime we'll try to cover as much as possible. . . .

## FIESTA DE AMISTAD

Del Rio, Texas, was the scene of another modeling contest linked to a civic celebration and where visitors to the Fiesta de Amistad learned of RC flying. Held on the U. S.-Mexican border, October 23 and 24, spectators from the two countries lent an international air to the competition. Hosted by the BORDER EAGLES RC CLUB, the meet had spacious accommodations on Laughlin Air Force Base. Capt. Stan Jansen heads the club which has 23 airplanes flying among its 15 members. Single channel flying is most popular since only 3 of the planes are multi-channel jobs. Chuck Winchester is their top contest flier having won the Air Force Training Command rudder crown as well as placing at the San Marcos and Austin meets during 1965. Turnout at the meet was light for this first affair but plans for next year are optimistic for growth of this latest addition to the contest circuit.

## NATS FLIGHT DATA

L.A. Johnston (122 Valencia St. Garland, Tex.) our favorite flight line coordinator whom we mentioned in the December issue, sends added info on the number of flights made at Willow Grove which was quoted in our November column as being less than at Dallas in 1964. "LA" proves his dedication to a smooth running flight by maintaining statistics of the flights made each year at the annual National meet so that a competent analysis may be made of the effectiveness of flight operations. (Johnston was a coordinator for the 64 and 65 Nats, has offered his services for the Chicago Nats this year.) "LA" reports that 167 fliers scored 927 flights for an average 5.6 rounds. In 1964 an average of 9.1 flights was attained by 112 fliers making 1021 flights, 94 more scores than in 1965. Reduced flights, Johnston says, resulted from less time being afforded the pattern event as a consequence of more pylon, 5PM shut off each day, and 11AM quitting time on Saturday to accommodate scale flying. All in all, about 8 hours less time was available. In addition, fewer drop-outs by Novice fliers who had their own hot competition going, as well as few-

(Continued on Page 52)



# SUNDAY FLIER

By KEN WILLARD

**Our "small plane man" comes up with a sport Goodyear design for 3+1 proportional or single channel. To be presented later this year.**



**T**HE mail gets more interesting with each issue of RCM. You modelers that are Sunday fliers, like me, have some pretty strong opinions. Maybe this would be a good time to air them. There isn't room to publish all of the thoughts expressed, so I've tried to pick out a good typical example.

The subject is "Small Multi for Small Pocketbooks." We all know that multi rigs and proportional gear are more expensive than single channel, but a lot of modelers would still save up and buy the big rigs, except that there's still that great big model, expensive engine, and gas bill.

Does it have to be that way? Read what Sherwood Heggen, of Bricelyn, Minnesota, says:

"I have had something on my mind for some time, and I haven't found a solid reason as to why it can't be done. As a matter of fact, I've partially proved that it can be done. . . . I've wondered ever since I bought my multi (10 channel Kraft reed) last spring why there are no contest caliber airplanes below

4½ pounds or below .45 engines. These airplanes come out smelling expensive! Not only in construction, but in the fuel these monsters drink!

"I was told by a leading kit producer that a small multi would not be good due to its weight. I went ahead and built my small multi and also flew it. The plane was a Minnie Mambo with 8 channels — RETM — and an OS 15 RC engine. The plane was completely stock except for a ¼" plywood underside for battery hatch, landing gear, and servos, a strip of TE stock for elevator and maple mounts for my .15. The manner in which this plane flew was truly a thrill, especially to a newcomer to multi, like me. . . . After having launched it off for its first official flight, I about shook out of my drawers as I watched it scream away from me like a scalded dog. Gathering myself back together after being surprised by the speed of this thing . . . with about 150 feet of altitude and what I would guess to be about 55 mph air speed, elevator and right rudder were applied, and what do you know —

a roll! Not a funny looking barrel roll, but an **axial** roll! Who says small RC isn't feasible? Loops? Beautiful! Power on spins were the 'Wow! Look at that' type. Even though the wing loading (24 oz.) was high, the plane could be slowed down quite well for a fairly easy touch down. . . .

"The money angle of RC is a big one to fellows like me. Trying to pay for school and keeping up the car that gets me to that distant school doesn't leave too much, if any, in the budget for something to fly. . . . I have to stop eating for a week so that I can buy a gallon of fuel! There always seems to be a mishap, too, which wipes out that wing! Back to the bank account for about 8 bucks for that 600 sq. in. job. First thing you know there's \$30 gone and it didn't all have to be spent. The airplane doesn't have to be big. My Minnie Mambo proved that. If the plane isn't big the engine doesn't have to be big. Thus, we have killed 2 birds with one stone. The materials for the plane will cost less, and the engine won't take as much fuel. Now I'm not saying that a 3 footer with stunting capabilities is in order, but why in the world can't somebody come up with a stunting 4 footer!! Sure there are high wing planes for 1-6 channels, but is this true multi stunt? No! The planes have positive incidence, a whole pile of dihedral, and no provisions for ailerons. The positive incidence is most undesirable since you have to fight to keep the plane from climbing after a loop, dive, or high speed pass. Also inverted flight is poor. This is what I would like to see:

(Continued on Page 50)



Top Dawg in sidview. 38" span, Orbit 3+1 proportional on R. E. M.





PRICE LIST	
Adhesive Kit	\$3.95
AMECO Foam Blocks (pair)	3.50
AMECO Foam Cutter w/Electrical System	27.95
Entire AMECO Foam Core Kit which includes all items above plus full instructions.	\$4.95



#### GUARANTEE

Every AMECO product is guaranteed against defects in material or workmanship. If you are not 100% satisfied with any AMECO product, return it in the same condition as received and AMECO will promptly refund the entire purchase price.

## WORTH WAITING FOR!! The QUALITY line of RC foam products from AMECO

The AMECO Foam Core Kit (both pictures) provides everything that the average modeler requires for perfect wings, stabilizers, fuselages, etc.

The AMECO Foam Core Kit Includes:

- Adhesive Kit — one pint of Quick-Bond foam cement, one pint of Thinner, roller-applicator.
- Amecore Foam — two 12" x 3" x 36" blocks — a high strength-to-weight ratio polystyrene foam which requires no coring!
- The Incomparable AMECO Foam Cutter — after months of development, our prototype cutters have cut hundreds of cores without a single

electrical or mechanical failure! Features includes one- or two-man operation; comfortable handle grip; a power switch located by the right handle for ease of operation; balanced design; no ceiling suspension required; close tolerances held through factory jig construction.

- Complete Electrical System — cool running step-down transformer pack with five foot power cords.
- Complete Instructions With Every Kit!

ORDER TODAY — PROMPT DELIVERY (all items sent postpaid within U.S.A.)

Send Check or Money Order (Sorry, No C.O.D.'s) to:

## ADVANCE MODEL ENGINEERING CO.

P. O. BOX 300 — NUTLEY, N. J. 07110

"Progress through Quality"

Telephone (201) 667-1702

### SUNDAY FLIER

(Continued from Page 49)

#### KEN WILLARD SAYS . . .

"DON'T MISS THE  
R/C MODELER ANNUAL,  
AVAILABLE IN FEBRUARY!"

"Four foot wingspan, low wing, 10 channel, trike gear, zero trim, dihedral which is meant exclusively for an aileron ship, and engine size from .19 up to .35. What would be wrong with this?"

Nothing. Individually, a lot of modelers are doing something similar to Sherwood's desire.

But maybe his comments on high

wings not being true multi stunt could rile up some modelers. Maybe some high wing designs aren't good stunters, but some of the best contest designs in existence are high wing — or, if you prefer, shoulder wing designs.

The control and performance of a multi design is not so much a function of wing placement as it is a combination of force balances combined with the individual skill of the pilot.

For a smaller model, using multi gear, the high wing could even be a better all around performer.

In either event, the rising interest in a good small multi design is certainly evident, and I'm all for it, but with a little proviso. And that is, for true all around utility, the model should also perform well with single channel equipment, either servo or escapement. And that presents a good problem in design, particularly if you want it to look nice, and not just be "another multi design." We are all aware of the fact that multi

designs are all getting to look very much alike. The exception, of course, is the "Goodyear racer" type, recently popularized by Jerry Nelson.

A few years ago I proposed a 1/2A pylon racing event, with certain scale-like requirements so the model would be realistic. The "Scorcher," a 1/2A racer, was designed to meet the requirement. But the idea didn't catch on until Jerry modernized it with his .40 powered class.

Well, since there have been so many letters asking for a small multi, I've designed one that's intended to fill the requirement. After we've completed the flight tests and eliminated any bugs that may show up, we'll publish it some time this coming spring.

Also, for the single channel enthusiast, we're building separate versions using one of the new servos.

The model has a "family resemblance" to the old "Scorcher" but is completely new — bigger, heavier, more room, more power, but right in the size and power class you fellows are asking for.

But let me close with an observation — no matter who designs it, or what configuration it has, no four foot, or smaller, design will ever compete successfully against the six footers — all other things, like the pilots, being equal. The reason is obvious; the bigger, heavier and more powerful contest designs, because of their mass inertia, will always be smoother, and can handle different wind and weather conditions better.

Conversely, the big jobs fly faster, hit harder, take more time and money to repair, cost more to operate, and are harder to transport.

So let's go small multi (with a single channel version for slim wallets), for all around funday Sundays. I'll keep you posted.



Wally Marra of Sunnyvale, Calif., with 42", 3 1/4 lb. original. Fox 15 and 6 channel on R. E. M. Flies fast but easily controlled. Spins like a top. 3 transmitters, one mounted horizontally.





# NEW

## PYLON RACING ACCESSORIES

for the Miniature Goodyear Event  
of HIGH IMPACT, PAINTABLE, MATERIAL



6719 SALT LAKE, BELL, CALIF.

Nylon

### WING MOUNTING KIT

Four Piece WING MOUNTING KIT .99c



### RACING SPINNERS

2 1/2" Diam. \$ 1.59    2 3/4" Diam. \$ 1.79



Two Piece, Held with Prop-Nut and Washer

BUBBLE CANOPY .98c 10"

### Moulded WHEEL PANTS

Set of Right and Left \$ 3.10    Length 9 3/4"

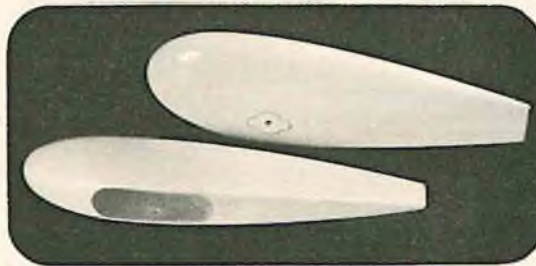

### Moulded CHEEK COWLS

Set of Right and Left \$ 1.98    Length 8 3/4"



### RACING PILOT

2 5/8" SCALE PILOT \$1.10



### RACING WHEELS

SMOOTH CONTOUR 2 3/4" Diam.  
SC-2 \$ 2.25



HEADREST CANOPY .79c

Coming Soon "La Jollita" Goodyear Racer

## CUNNINGHAM ON R/C

(Continued from Page 47)

#3 RUDDER/AILERON CONNECTIONS

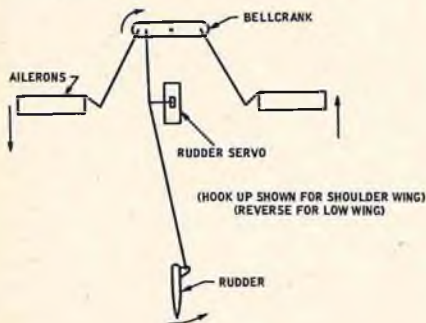

insure that the linkage will really give you a right turn at the rudder as well as a right turn at the ailerons. The new three-plus-one proportional systems couple the ailerons electronically to the rudder. It is my opinion that the rudder is by far the most useless control of all, and that many more and pleasing flights will be made through the use of aileron only aircraft than is now being done. Nevertheless, check to see that your potential hookup does come out right. I have always been tempted to cross-control this type of coupled system to see just what would be the result of this "mix-and-match," but have never had a ship that was expendable enough to try out the idea! It could be surprising and

might lead to something that no one else has yet tried.

Another illustration shows yet another overlooked, simple function of coupling controls—that of connecting the throttle servo to a set of wing flaps, or if you wish to be different, to a set of dive brakes hinged to the sides of the fuselage. Since most multi ships are balanced much further rearward than their full size counterpart, it is advisable to throttle back in easy stages in order to prevent a loop with fully extended flaps. As in everything else in aircraft design, there are more than just one way of doing something, and a number of different types of flaps. The simplest form is to drop the trailing edge as in the full-span aileron setup. This creates additional lift as well as drag. If you hinge a drag flap to the bottom surface of the wing, this will not create lift but only drag. At any rate, you will have to experiment with the correct amount of flap area for your ship. The degree of flap extension should be between 45 degrees and 60

#4 THROTTLE TO FLAPS

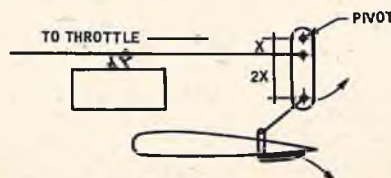

degrees from horizontal.

Another method of tying flaps to the throttle has been used by my good friend Bob Lutker with much success. Bob rigged up a micro-switch to his throttle servo in such a manner that when he passed the mid point on his throttle control the arm on top of the servo contacted the micro switch, thus energizing another circuit containing an additional servo, thus lowering the flaps. Still another hookup of a similar type would be to rig your throttle servo in such a manner that one half of it is used for throttle and the other half used for flaps. You throttle back to low engine, using one half of the servo operation, and then from there on the remaining half operates the flaps. This system has many disadvantages, but perhaps these thoughts may trigger a better idea on your part.

One of the drawings accompanying this article illustrates a simple setup for obtaining nose gear control along with rudder. This, of course, is old hat to almost everyone now, but it is surprising how many systems are found that make a very hard problem out of a simple one. The drawing is more or less self-explanatory. Use a two inch bellcrank of one of the popular two-bit control line variety and mount it to the side of the body in a vertical position,

(Continued on Page 56)



# For a good steer in multi-boat hydro RaCing . . .

look to the pioneer and leader in competition-proven design in hulls and fittings! . . .

## OCTURA HYDROS

are designed to meet all the rugged requirements of multi-boat racing: acceleration, cornering, straight-away speed, and maneuverability.

**WHITE HEAT 30**  
for .20 to .40 engines.

**WHITE HEAT 60  
& 4-60**  
for .45 to .65 engines.

**WHITE HEAT V;  
X; XIV; XV**  
for O & R "Compact" 1 h.p. engine.

If your dealer cannot supply you—send stamped, self-addressed envelope for literature and prices.



## OCTURA ACCESSORIES

for trouble-free designs, competition proven power and accessories: hulls, motor mounts, flywheels, universals, stuffing boxes, struts, rudders, cowlings, propellers, "Kool Klamps, and the correct power plants for your hulls.



## OCTURA MODELS

8148 Milwaukee Ave., Niles, Illinois 60648

**YOUR ONE SOURCE FOR ALL R/C BOATING SUPPLIES!**

## WORLD WIDE R/C

**PARDON US** if we brag just a little about our products and services. Our many, many fine customers, be they men or women, novice or expert, know **WORLD WIDE** as the **DEPENDABLE** place to shop for radio control components, expert service and friendly counsel.

We have been told that only at World Wide can the R/C hobbyist find such a wide range of proven equipment at prices pleasing to any budget as well as courteous service and accurate answers to the most knotty problem. This is as it should be. Our people are all modelers.

Come into our new store or write (our mail order department is the greatest) and let us prove how well satisfied **YOU** will be with World Wide. Drop us a card or letter for your copy of "Quick Blips" or shoot us a dime for our latest catalog. Please don't forget your name, address and zip code.

Write: World Wide Radio Control  
7845 Wyoming Avenue  
Dearborn, Michigan 48126



## KITS AND PIECES

(Continued from Page 46)

lovable editor is busily jabbing pins in a Mattel doll which he has affectionately named Bernie — all this because I failed to plug the forthcoming Radio Control Modeler Annual, to be available February 15th. There, I said it, now cut that out . . .

Actually, the Annual will be a must for every RC'er—sport, Sunday, or contest flyer. The editors and staff of RCM have worked tirelessly to assemble material the world over to put forth the kind of Annual that **you** want. Construction articles with full size pull out plans, feature articles, how-to articles, electronic articles, hints and kinks, equipment data, and much, much more. There was only one small problem, though — we had to forcefully convince The Dewey that a 20,000 word Editor's Preface and a life-size pull out full-color photograph of himself (autographed) was not really essential.

Anyway, we all have our idiosyncrasies. Don't miss the Annual.

Don't forget the Toledo Conference, February 26-27. This is one of the biggest RC shindigs of the year.

Till next month — see **you** at the . . .  
. . . oh, well, anyone for ice fishing?

## TOP OUT

(Continued from Page 48)



Ed Narlett and Chuck Winchester show their single channel equipment. Pair won rudder class honors at Del Rio, Texas, meet. (Dig the distinctive polka dot flight caps, sported by all Border Eagle R/C Club members.

er aborted flights (indicating better engine performance, radio gear improvement, and advances in flying ability) kept flight lines fuller in 1965.

Johnston lists three possible means of keeping the contest a valid demonstration of flight talent and equipment capability: (1) Limit entry (regional qualifying), (2) Increase flying time (7 A.M. to 7 P.M. since daylight is available) and, (3) Eliminations. We heartily endorse no. 2, but to overcome the need for more Navy judges we agree with "LA" to augment the need with AMA teams from 4 or 5 sections of the country. This last idea is not new but it's not known if any effort has

(Continued on Page 62)



# The Roostertail



The Official Publication of the  
International Model Power Boat  
Association

General Office:

2405 19th Avenue Broadview, Ill.

When compared to solo racing, the mad dash around pylons in multiple boat racing is strangely intimate. Each pilot knows exactly who his opponent is and their duels are often likened to the clashes between armoured knights of Medieval times.

As this excitement has caused an increasing interest in multiple boat racing, it may be timely to consider a new class for racing, and discuss its merits. Would it not be interesting to have a boat race where the boats could compete on an equal basis? The rules put forth would be identical to the existing multiple boat rules for racing with just a couple of additions. In this event, all boat hulls must be of an SK type configuration and all engines must be of a stock RC type. Engine modifications and hot special fuels would not be permitted in order to allow the boats to compete on the merit of their design and the skill of the pilot. The boats must be painted in a multiple color scheme and have racing numbers on each side of the boat at least 1" high and prefixed by the letters "SK." It would not be necessary for the boat to have a V-drive, but any accessory which would add to the realism of the boat would be desirable. All races would be started with five boats whenever possible, and would be for ten laps on the IMPBA oval.

It is necessary to hear from the membership and get opinions before the rules can be completely formulated. Does this appeal to you or would you prefer that the hull design be left open, and only restrict engines and fuel to "stock" types? Put your opinion on a card or letter and send it to the IMPBA GENERAL OFFICE.

Gary Preusse has been trying to

(Continued on Page 54)

## NEW DIGITAL SERVO compatible with DIGITRIO

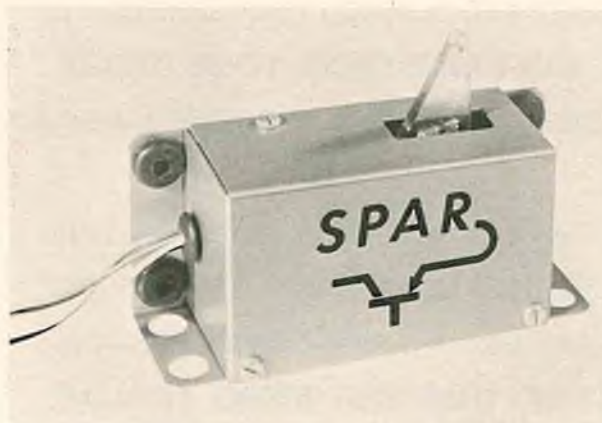

SMALL SIZE

LIGHTWEIGHT

LOW COST \$29.95\* FOB

\* California Residents add 4%.

DISTRIBUTORS WANTED!



ELECTRONICS • 15302 Oak Canyon Road • Poway, California 92064

### ARISTO-CRAFT'S ...

#### ARISTO CESSNA 182 KIT \$39.95



A full-scale model plane for multi-channel or proportional R/C flying. All parts are die-cut; complete with hardware, tank, steerable nose gear and formed landing gear. Wingspan: 72", Length: 56". Engine: .29 to .61.

Also available with 56" Wingspan.....\$29.95  
Same features; Engine: .09 to .19

#### ARISTO CESSNA 319 KIT \$69.95



A twin engine model for multi-channel or proportional R/C flying thrills. Has a wingspan of 74"; length: 53"; engines: .19 to .35. Includes die-cut parts, hardware, tank, steerable nose gear and formed landing gear. Controllable with one engine operation.

### GAS MODEL KITS

### GIANT RADIO-CONTROL



#### ROYAL GRACE R/C KIT \$27.50

For multi R/C. Wingspan: 57 1/2", Lgt. 46 1/2".  
Engines: .35 to .60. All parts of balsa & hardwoods.



#### AERONCA CHAMPION R/C KIT \$24.50

All wood parts pre-fabbed, for single channel or multi R/C. Wingspan 60", Lgt. 43 1/2",  
Engines: .15 to .35.  
(Covering material & wheels not included)

**POLKS HOBBIES**

SEND CHECK or MONEY ORDER, NO COD'S  
314 FIFTH AVE., N. Y., N. Y. 10001  
At 32nd St. (DEPT. RC2 6)

DEALER INQUIRIES INVITED



# THE R/C MODELER ANNUAL

TO BE RELEASED IN FEBRUARY  
WILL BE A LIMITED EDITION VOLUME  
AVAILABLE FROM YOUR DEALER  
OR DIRECT FROM R/C MODELER MAGAZINE

THE EDITORS AND STAFF OF THIS PUBLICATION HAVE STRIVED TO PRESENT A HARD-COVER PUBLICATION THAT WILL BRING YOU THE FINEST COLLECTION OF ALL-NEW MATERIAL THAT YOU CAN USE THROUGHOUT THE YEAR, IN SHOP AND FIELD. REGARDLESS OF YOUR INDIVIDUAL INTERESTS IN RADIO CONTROL, THE RCM ANNUAL IS FOR YOU.

THERE HAS NEVER BEEN A PUBLICATION SUCH AS THIS PRESENTED BY THE MODEL AVIATION PRESS. TO BE ABSOLUTELY CERTAIN OF RECEIVING YOUR COPY, PLACE YOUR ORDER TODAY! YOUR R/C MODELER ANNUAL WILL BE MAILED TO YOU AS SOON AS AVAILABLE.

R/C MODELER MAGAZINE  
P. O. BOX 1128  
LAGUNA BEACH, CALIF. 92652

Please enter my order for the R/C Modeler Annual, available in February, 1966. I have enclosed \$2.00 plus 50c for mailing charges.

NAME

ADDRESS

CITY

STATE

ZIP

## ROOSTERTAIL

(Continued from Page 53)

stir up a little interest in distance running in the IMPBA. His first attempts were a little disheartening but he is gaining the knowledge necessary for longer and faster runs. One cannot imagine the difficulties that may arise when attempting a long distance run with a model boat. First, you must choose a place to run that is free of a great deal of debris. Even small amounts of dead leaves or sticks on the surface of the water will be enough to abort the run. You must have a dependable chase boat and a very patient and willing pilot, you must have good weather, not too windy; and, you must have an IMPBA official or a member of the power boat squadron on board. However don't be discouraged. After running model boats for many years from the shore, it is quite a worthwhile experience to get into a real boat and operate your miniature craft from an equal footing. You can actually get within a half-dozen feet of your boat and judge its operation with crystal clarity.

Gary used a TAS P-7 in a fibre-glass Cobra hull for the distance run. The engine was stock except that it had been water cooled and the intake ports had been enlarged. During the year the boat has run more than 500 miles in reliability tests and endurance runs. Incidentally, at the close of the boating season this boat established a new proto record in the F class. Tests early in the season were conducted to determine carrying capacity of the boat, fuel consumption of the engine and approximate speed under varying conditions. After initial tests had shown that the engine would give almost 100 miles per gallon on gas and oil, he decided to fit the boat with two 1-quart fuel tanks. This mileage was derived from our estimate of the boat being capable of 20 miles an hour with a ready-to-run weight of slightly over 20 pounds. Since the engine will run an hour and a quarter on a quart of fuel it has an approximate range of 50 miles. All of the tests were made with a complete cockpit interior which could have been sacrificed for more fuel capacity without loss of performance. Ultimately the boat had been run with a total weight of over 30 pounds with only a loss of 3 miles an hour. This seems to indicate that the boat and engine are capable of running for over 12 hours nonstop!

Armed with these facts and figures, he talked a friend into making a shake-down run in a small local river. On this first run it was discovered that it is much wiser to have a lesser degree of rudder movement, thus enabling you

(Continued on Page 57)



# FIBREGLASS

(Continued from Page 37)

This will make it possible to provide for the flange on the female molds. Fill any cracks between the plugs and planks, then apply at least 2 coats of Hobby Pox white. It is important that each coat is well hardened before the female mold is started. This will prevent having the finished lift off when the resin is applied. For a smooth final finish, rub down with Brasso, or other good rubbing compound. Now your "plugs" are finished.

The fiberglass female mold will be mounted like a bathtub in a 3/4 inch plywood frame. (See photograph 3.)

The first step is to wax and polish the "plugs" thoroughly—5 times with Simoniz or mold release wax #5. If you want to make doubly sure the mold won't stick spray a coat of P.V.A. (poly vinyl alcohol) release agent onto the plug. It will form a light, even, and easily-released film.

The next step is to apply the Polyester gel-coat by lightly brushing. (Don't forget the hardener!)

If you wish to spray, it can be done by adding acetone to achieve a thin enough viscosity. A dark-colored pigment in the gel-coat will make it easier to gauge that you have an even coverage.

Fibreglass material is available in cloth and as a non-woven mat. The mat is preferred for this job because it will conform to almost any curve once it has been wetted with resin. It is also much stronger and will hold its shape much better than the cloth. The mat fibres are not bundled like the strings of the cloth, thus the resin penetrates more thoroughly. The first layer of mat should be 1 1/2 oz. weight split in half. This thinner layer will adhere tightly to the gel-coat as it is rolled on. The best applicators for applying the resin to the mat are a small roller brush such as those used for trim when painting a wall, and a small brush for patting out air bubbles. It is essential to eliminate all air bubbles as they will form weak spots and distortions in your molds or finished product.

When this first layer of mat has hardened to a "cheesy" toughness, cut the surplus off, leaving a 1 inch flange all around the plug on the plank as shown in photograph 2.

Apply 2 more full thicknesses of mat over the half thickness and trim each one when it is "cheesy." If you let them harden completely you'll need a hack saw to trim them—and dull a good blade!

(Continued on Page 58)

# NEW—From ACE R/C

**NOW** An electric brake for your R/C models, developed by Dr. Walter A. Good. In the testing stage for over a year, this lightweight unit provides up to 8 inch ounces torque drag on 2.4 volts, with a drain of only 160 mls. May be used with 2 to 6 volts. Coil resistance is 15 ohms.

Now get electric braking for your R/C model in this Ace exclusive, by special arrangement with Walt Good.  
Braking action is by magnetism—employs no shoes. Use of special formula alloy, cuts residual magnetism to almost nothing.

Will fit most R/C wheels. Designed for a 5/32" axle.  
Packaged with one brake and complete instructions per package.  
No. 25A55—Ace-WAG Electric Brake . . . \$6.95

# NEW! ELECTRIC BRAKES FOR YOUR R/C MODELS!

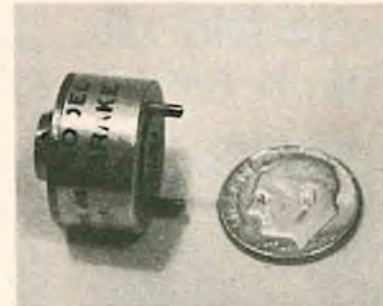

ACE RADIO CONTROL • BOX 101 • HIGGINSVILLE, MISSOURI 64037

## CHANGE OF ADDRESS

Attach magazine label here

If you're moving, please let us know six weeks before changing your address. Place magazine address label here, print your new address below. If you have a question about your subscription, place your magazine address label here and clip this form to your letter.

Name \_\_\_\_\_

Address \_\_\_\_\_

City \_\_\_\_\_ State \_\_\_\_\_ Zip \_\_\_\_\_

# YOU ARE NEEDED!

## ACADEMY OF MODEL AERONAUTICS

F.A.I. Internat'l  
R/C Team Transportation Fund,  
1239 Vermont Avenue, N. W.  
Washington, D. C. 20005

I am contributing the sum of \$\_\_\_\_\_ by  
check\_\_\_\_\_ cash\_\_\_\_\_ money order\_\_\_\_\_ to help support  
the F.A.I. Internat'l's R/C Team Transportation  
Fund. Please record my contribution in  
the name of:

Name \_\_\_\_\_ Age \_\_\_\_\_  
Address \_\_\_\_\_  
City \_\_\_\_\_ State \_\_\_\_\_

**ACADEMY OF MODEL AERONAUTICS**  
1239 VERMONT AVENUE, N.W., WASHINGTON, D.C. 20005

## MEMBERSHIP/LICENSE APPLICATION

Name \_\_\_\_\_ Please Print Plainly  
Street Address \_\_\_\_\_  
City & State \_\_\_\_\_  
Zip \_\_\_\_\_  
New A.M.A. No. will be assigned unless you have one already. \* Fee is included (please check below to indicate license) to which remittance is enclosed.  
 JUNIOR (up to but not incl. 16 years old) \$4.00  
 LEADER (17 years or older) \$10.00  
 FULL STAMP \$1.00  
 If you are a member of another organization, please attach your membership card and indicate organization name.  
 Your license classification is based on your age as of July 1 each year.

All stamps required on A.M.A. license card. To complete in full members must be provided with a letter from their local club or club leader recommending a license classification and stating the reason for recommendation. This letter must be submitted with the application. Club leader's name and address must be provided. If you are a member of another organization, please attach your membership card and indicate organization name. If you are a member of another organization, please attach your membership card and indicate organization name.

# CANADA

WESTERN CANADA'S FASTEST  
GROWING MAIL ORDER HOUSE

## CALGARY HOBBY SUPPLY

1225 11TH AVE. S.W.  
CALGARY, ALBERTA

## R.C. SPECIALISTS AUTHORIZED KRAFT DEALER

Everything for the Aeromodeler  
Full line of all major mfgs. Most deliveries from stock. Complete stock Sig Balsa wood. Check our prices first.

Send 25c for catalog

## Radio Control HEADQUARTERS

AMERICA'S HOBBY CENTER 145 West 22nd St., N. Y., N. Y. 10011

- ALL ORDERS OVER \$3.00 PREPAID...  
ORDERS UNDER \$3.00 ENCLOSE 25c FOR POSTAGE AND HANDLING.
- | RADIO CONTROL EQUIPMENT   |  | Reg.   | Sale   |
|---|--|--------|--------|
| CITIZENSHIP TWO TRANSMITTER & 10-10 RECEIVER.....   |  | 189.90 | 129.95 |
| CITIZENSHIP RSH SUPER NET RECEIVER.....   |  | 24.95  | 25.95  |
| CITIZENSHIP SP2 TRANSISTORIZED TRANSMITTER.....   |  | 39.95  | 28.95  |
| CITIZENSHIP 4LR w/ TCR TRANSISTORIZED SERVO (ECU).....                                    |  | 25.95  | 18.00  |
| ELECTRONICS TRU FLITE ALL TRANSISTORIZED TRANSMITTER.....                                 |  | 29.95  | 24.95  |
| ELECTRONICS SIMULATED ENGINE ESCAPEMENT.....  |  | 14.95  | 9.95   |
| CITIZENSHIP 8 CHANNEL SUPERNET RELAYLESS OUTFIT WITH 16L-16L-11D SERVO, TCR SERVO(2)..... |  | 207.15 | 128.95 |
| ARAFI RELAY RECEIVER VICE TRUCK.....  |  | 29.95  | 12.95  |
| 2MR MIMETIC COMPACT ESCAPEMENT.....   |  | 7.95   | 5.95   |
- READY TO OPERATE R/C OUTFIT BOTH TRANSMITTER & RECEIVER \$24.88
- FULLY TRANSMITORIZED  
RECEIVER: VOLT RELAYLESS DEPT. 1.2 VOLT REG. BATTERY 1 1/2" x 1 1/2" TURNS: 300 INDEPENDENT PERCELLS MEASURES: 2 3/4" x 2 1/4" x 1/2" COLLAPSIBLE ANT. WIRE SWITCH.
- | RADIO CONTROL ACCESSORIES                        |  | Reg. | Sale |
|--|--|------|------|
| FAST & LINES Regular 29e Each...SET OF FOUR FOR  |  | .90  | .90  |
| INLINE TRIM BAR...JACK SET FLEET TYPE 2          |  | .55  | .55  |
| 24 FEET FLEA HEIGHT HOOD-UP WIRE (8 COLORS)..... |  | .60  | .39  |
- | RADIO CONTROL ENGINES |             | Reg.               | Sale        |
|-----------------------|-------------|--------------------|-------------|
| ENR .05 R/C.....      | 9.95 6.39   | RECEV. 25 R/C..... | 12.95 9.49  |
| FLEET 158 R/C.....    | 14.95 16.00 | FOX 50 R/C.....    | 34.95 29.95 |
- | RADIO CONTROL AIRPLANES                                |       | Reg.  | Sale |
|--|-------|-------|------|
| DUBOIL LIVEWIRE PURSUIT For. 28-.05 ENG. 66" WINGS PAN | 18.95 | 14.95 |      |
| DUBOIL LIVEWIRE CUSTOM For. 35-.05 ENG. 85" WINGS PAN  | 21.95 | 15.95 |      |
| ELECTRONICS LIBERTY 7 For. 30B-.05 ENG. 40" WINGS PAN  | 7.95  | 5.95  |      |
| BENKLEY R/C BUSTER For. 15-.35 ENG. 48" WINGS PAN..... | 18.95 | 9.95  |      |
- Send for our NEW R/C Catalog listing everything available in R/C  
CONTOUR'S S RECEIVER KIT \$7.95, ASSEMBLED \$13.05, FAM PIONEER RECEIVER \$19.95, FAM ECHO TRANSMITTER \$29.95, MC WIGGAM CHARGER \$5.95, ASTRO 1000 MONITOR \$14.95, ASTRO PEE BEE RECEIVER AND TRANSMITTER \$24.95, ASTRO 33 RECEIVER AND TRANSMITTER \$30.00, 85% 70" CHARGER \$7.95, CRYSTAL: 15, 20, 25, 30, 35, 40, 45, 50, 55, 60, 65, 70, 75, 80, 85, 90, 95, 100, 105, 110, 115, 120, 125, 130, 135, 140, 145, 150, 155, 160, 165, 170, 175, 180, 185, 190, 195, 200, 205, 210, 215, 220, 225, 230, 235, 240, 245, 250, 255, 260, 265, 270, 275, 280, 285, 290, 295, 300, 305, 310, 315, 320, 325, 330, 335, 340, 345, 350, 355, 360, 365, 370, 375, 380, 385, 390, 395, 400, 405, 410, 415, 420, 425, 430, 435, 440, 445, 450, 455, 460, 465, 470, 475, 480, 485, 490, 495, 500, 505, 510, 515, 520, 525, 530, 535, 540, 545, 550, 555, 560, 565, 570, 575, 580, 585, 590, 595, 600, 605, 610, 615, 620, 625, 630, 635, 640, 645, 650, 655, 660, 665, 670, 675, 680, 685, 690, 695, 700, 705, 710, 715, 720, 725, 730, 735, 740, 745, 750, 755, 760, 765, 770, 775, 780, 785, 790, 795, 800, 805, 810, 815, 820, 825, 830, 835, 840, 845, 850, 855, 860, 865, 870, 875, 880, 885, 890, 895, 900, 905, 910, 915, 920, 925, 930, 935, 940, 945, 950, 955, 960, 965, 970, 975, 980, 985, 990, 995, 1000.

RED HOT BUY !! CITIZENSHIP ANALOG  
CITIZENSHIP ANALOG SYSTEM \$250.00 WITH A FREE BONUS GIFT  
CERTIFICATE FOR 50% OF MERCHANDISE OF YOUR OWN CHOICE...!

WE ALSO SELL TO DEALERS  
HOO-ADO AGENCY DISTRIBUTORS EVERY REPUTABLE R/C ITEMS. WE HAVE THE WORLD'S LARGEST INVENTORY OF R/C EQUIPMENT. WRITE FOR OUR SERVICE PROGRAM.

WE WILL PAY YOU TO SEND FOR THIS WORLD'S NEWEST & MOST COMPLETE R/C CATALOG

SEND ONLY \$25  
For our New R/C Catalog  
Get a 50% CREDIT  
Refundable With Your Next Order

HERE IS OUR BRAND NEW R/C FANS!  
PHOTOS & DESCRIBES ALL FANBUSS  
BOMBS EQUIPMENT & ACCESSORIES...

Order by Mail Form  
AMERICA'S HOBBY CENTER, DEPT. RC1M  
146 WEST 22ND ST., N. Y., N. Y. 10011



# NEW! TAKE OFF PRODUCTS BY RAND MFG. CO.

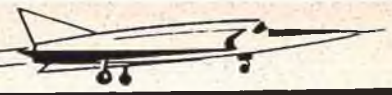

## ACTUATORS AND SERVOS FOR R/C

There's someone new in the radio control business — Rand Manufacturing Company, manufacturer of precision mechanical devices since 1957. And now entering the modeling field with new "Take Off" products, including these three radio control actuators. With more to come — the complete line of actuators and servos for Pulse and Proportional Control Systems. Be on the look-out for them.



New "Take Off" cleaner.  
8 oz. makes one gallon.  
Sprayer included.....\$1.98

**LR3 Features:** (1) Proportional rudder and elevator plus positional engine control. (2) Use with any Pulsar (or Pulse System). Optimum Pulse Rate 4-12 P.P.S. 6 P.P.S. neutral. Optimum Pulse width 70-30%—30-70%. (3) Fully R. F. suppressed 5-pole, double-brush, highest-quality motor. (4) No tricky linkages—all push rod hookup. (Beginner's Delight). (5) Designed specifically for galloping ghost operation, utilizing an entirely new concept for "Gallopless" flying. (6) The most proportional control for the least money. (No tinkering. Ideal for beginners.) (7) Reliable 2 hour operation per charge using 500 M.H. NiCad Batteries. (8) Power Supply: plus or minus 2.5 volts (5 volt center-tapped supply). Size: 1" x 1-11/16" x 2". Weight: 1/4 oz. \$19.95

**H.R. 1 Features:** (1) For use on all pulse proportional systems. (2) A fast-acting actuator, custom-designed to provide high reliability, high torque, light weight, and low drain. (3) Power supply: plus or minus 2.5 volt (5 volt center-tapped supply). Size: 1" x 1 1/2" x 2". Weight 1/4 oz. ....\$15.95

**H.R. 2 Features:** (1) Proportional rudder with positionable engine control. (2) A fast-acting actuator, custom-designed to provide high reliability, high torque, light weight, and low drain. Ideal for use with any Pulsar or Pulse System. Can also be used with H.R. 1 actuator on "Kicking Duck" applications. (3) Power Supply: plus or minus 2.5 volt (5 volt center-tapped supply). Sizes: 1" x 1 1/2" x 2". Weight: 1/4 oz. ...\$18.95



For "Take Off" products or catalog, see your local dealer or use this handy order coupon:

<p>How to order</p> <p>Orders will be shipped post paid within the U.S.A. and Canada. (Except Air Mail, add 25c each). Foreign countries, add 50c each for regular mail or \$1.50 each Air Mail. No C.O.D. please.</p> <p><input type="checkbox"/> Pre-paid cash with order only, please.</p> <p><input type="checkbox"/> Please send catalog.</p>	<p>NAME _____</p> <p>ADDRESS _____</p> <p>CITY _____ STATE _____ ZIP CODE _____</p> <p>AMT. Enclosed with order \$ _____</p>	<p>Product</p> <p><input type="checkbox"/> L.R. 3 _____</p> <p><input type="checkbox"/> H.R. 2 _____</p> <p><input type="checkbox"/> H.R. 1 _____</p>	<p>Quantity</p> <p>_____</p> <p>_____</p> <p>_____</p>
	<p><b>RAND MANUFACTURING COMPANY</b></p> <p>8909 HUBBELL AVE.      DETROIT 28, MICHIGAN</p>		

## CUNNINGHAM ON R/C

(Continued from Page 51)

or screw it to the motor mount bearer. It is simple, out of the way, and will allow for easy adjustment or removal. And, by directing the wire linkage through another surface, such as the bellcrank, removes most of the shock load from the rudder servo.

The next Mickey Mouse setup that we are going to explore is very interesting to me and has long been overlooked by almost everybody in the ranks of avid fliers. That is the ease of hooking up a drop mechanism to allow you to drop bombs, parachutes, streamers, or anything else at will. The illustration shows the first, and by far the easiest

setup. Simply steal a bit from the standard hookup for brakes, tie it to a release trigger, and there you have it. When you give up-trim, blooie, you hit your best buddy with a water bomb! In case you don't have a fiendish mind, or your childhood was a little secluded, penny balloons make the best water bombs and do give off a great splash upon contacting the ground. If you have an extra servo to use, or have created an extra servo by coupling some controls, then you can carry the bomb drop idea still farther and use this spare servo to trigger a very simple bellcrank setup to drop multiple bombs, such as the arrangement shown. If you think about it for a minute, I'm sure that you will realize that the good old rudder could be disconnected and the pushrod connected to a permanent

mount on the side of the body. The rudder servo could then be used for a bomb drop setup, utilizing the extreme limits of the servo travel to trip the bombs. The nose gear could still be hooked up in the normal method. Full deflection is almost never given to the nose wheel on takeoff. The rudder is generally used only on takeoff and in a spin, so why not?

Yet another idea for hooking up drop mechanisms is to use the trim or throttle servo to trip a micro switch, which in turn, operates a Mighty Midget motor, with a drum attached to the gear. The drum has a chord wrapped around it, and as the micro switch is hit, it runs the Mighty Midget, winding up the cord around the drum and pulling a series of releases to drop just about anything you wish.

The ideas are really endless, if only you will let your imagination wander a bit and get away from the idea that each piece of equipment can do only one job. The more ideas that you think up, the more that you will have to work with. Almost every idea starts

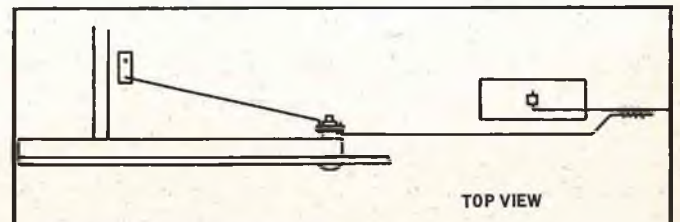
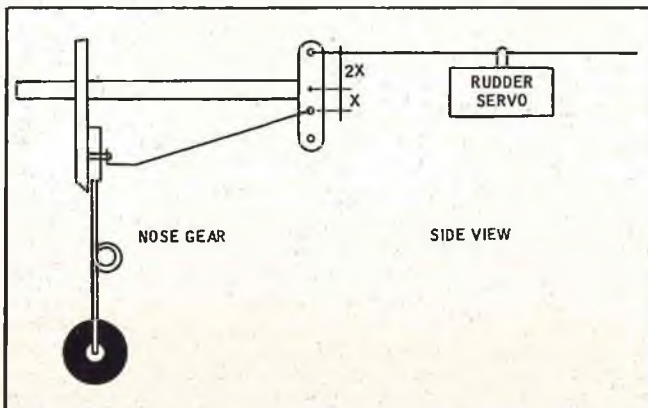



# The Only Complete Galloping Ghost System Available

**MODEL GG-1200**  
**\$119.95\***



The revolutionary new light-weight, fast-acting, custom actuator designed specifically to be used with this system has low drain and high reliability. The actuator utilizes an entirely new concept in mechanical design. The transmitter and receiver are the now-famous MIN-X Pulsmite 1200S combo which has proven itself with 2 years of reliable service to our customers. Audio frequency selective receiver virtually eliminates the effects of electrical noise and interference.

**FEATURES:** • Proportional (GG) rudder and elevator, plus positional engine • Completely matched system • Prewired harness including all necessary switches and connectors • No tricky linkages — all push rod hookup • Fully noise suppressed.

### SPECIFICATIONS

#### RECEIVER (Super Het):

Power Supply ..... 3 to 3.75 volt  
Size ..... 1" x 1 7/8" x 2 7/8"  
Weight ..... 3 1/2 ounces  
Operating Temperature ..... 20° to 140°F.  
Sensitivity ..... 2 Micro volts

#### TRANSMITTER:

Power Supply ..... 9 volt dry cell  
Size ..... 2 1/2" x 5" x 6 1/2"  
Weight ..... 2 lbs. with battery  
Operating Temperature ..... 20° to 140°F.  
Tone Frequency ..... 1200 cps.

#### ACTUATOR:

Power Supply ..... Plus or minus 2.5 volt. (5 volt center-tapped supply)  
Size ..... 1" x 1-11/16" x 2"  
Weight ..... 1 1/4" ounces including wire and plug

\*If purchased separately: Pre-wired harness, \$3.95 Servo (LR-3), \$19.95

# Dual Simul Proportional System

**FEATURING**  
**ENGINE CONTROL**  
**MODEL DP-1200**  
**\$199.95\***



The popular Pulsmite transmitter, Superhet 1200 receiver, and Minicoder PL have been teamed up with unique new servos to give fast-acting control. The fast-acting rudder and elevator actuators custom-designed for this system have a new design concept incorporating high reliability, light weight and low drain. Audio frequency selective receiver virtually eliminates the effects of electrical noise and interference.

**FEATURES:** • Proportional rudder and elevator, plus positional engine control • Completely matched system • All push rod hookup • Prewired harness including all necessary switches and connectors • Fully noise suppressed.

### SPECIFICATIONS

#### RECEIVER (Super Het):

Power Supply ..... 3 to 3.75 volt  
Size ..... 1" x 7/8" x 2 7/8"  
Weight ..... 3 1/2 ounces  
Operating Temperature ..... 20° to 140°F.  
Sensitivity ..... 2 Micro Volts

#### TRANSMITTER:

Power Supply ..... 9 volt dry cell  
Size ..... 2 1/2" x 5" x 6 1/2"  
Weight ..... 2 lbs. with battery  
Operating Temperature ..... 20° to 140°F.  
Tone Frequency ..... 1200 cps.

#### ACTUATORS:

Power Supply ..... Plus or minus 2.5 volt. (5 volt center-tapped supply)  
Size ..... Rudder and elevator — 1" x 1 5/8" x 2"  
Engine — 1 3/16" x 1 5/8" x 2 3/4" overall.  
Weight ..... Rudder and Elevator — 1 1/4 ounces each.  
Engine — 1 1/4" ounce.

\*If purchased separately: Pre-wired harness, \$4.95, Servo (HR-1), \$15.95 ea.

Send literature today. I enclose 15c for handling.

# MIN-X

MIN-X RADIO, INC.  
3714 GRAND RIVER  
DEPARTMENT 18  
DETROIT, MICH. 48204

Name \_\_\_\_\_  
Address \_\_\_\_\_  
City \_\_\_\_\_ State \_\_\_\_\_

with another, and perhaps you will come up with the best way to add the big "V" of versatility to your equipment and aircraft.

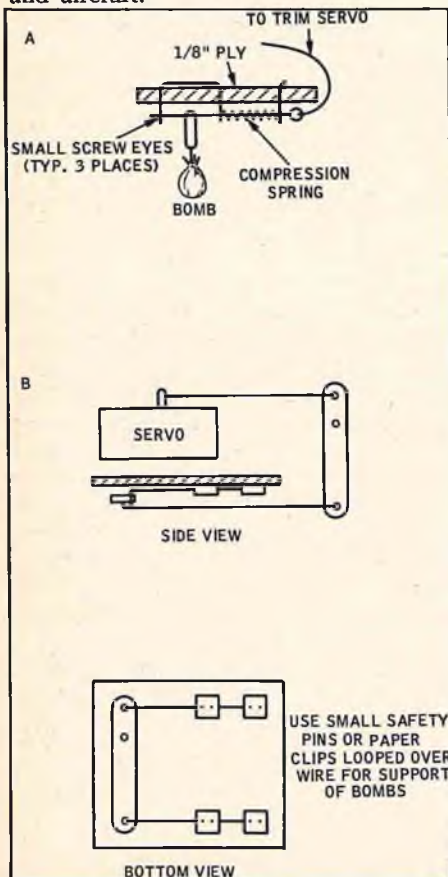

## ROOSTERTAIL

(Continued from Page 54)

to steer a straighter course. After approximately 10 miles, there seemed to be a smell of burned rubber coming from the model. After pulling along side to inspect the model's exhaust, it was observed that the water cooling had stopped discharging into the rubber exhaust hose, causing it to get hot and produce the obnoxious odor. At this, the engine was stopped to avoid overheating the engine. As he picked the boat out of the water, he noticed three little leaves draped evenly over the water pickup. Needless to say, the boat went back to the workshop for modifications. He ended up adding a weedless water pickup to augment the existing system, and this pickup seemed to do the trick.

Due to the press of the contest season, additional running was not scheduled until the fall. The course chosen was the Fox River, between Algonquin and McHenry, Ill. It would allow the room necessary for running and in the fall it would be relatively free from boat traffic. The crew consisted of Jack Peterson, owner and pilot of our 17-foot chase boat; Donn Jordan, I.M.P.B.A. secretary; Scott Jordan, who ran his O&R powered Cobra; and Gary Preusse. Scott and Gary started their engines

and proceeded up the river for a number of miles. Scott's boat was running considerably slower than Gary's due to a rich setting of the needle valve. This was one problem that caused Gary little concern because he could control his needle setting by radio. Scott decided that his boat would slow the pace too much and he aborted the run to allow Gary to continue at a higher speed. The distance between the two towns is 16 miles and we planned to turn around upon reaching McHenry and try for a round trip distance of 32 miles. Just a few miles short of McHenry Gary must have picked up some weeds which reduced his speed to a humiliating 12 miles an hour. They continued on to McHenry, and Gary drove his boat around in circles as Scott readied his boat for the down river portion of the run. As they started down river, the tables were now turned and Gary had the slow boat. They continued down the river for quite a few miles and thoroughly enjoyed the simultaneous running while flashing by the docks and people in their boats. At about 9:00 a.m., Scott's engine quit because of a lean needle valve setting, again proving the desirability of an RC needle valve. By this time in the morning they had already passed or been passed by quite a few boats including one express cabin cruiser approximately 30 feet long.

(Continued on Next Page)



### The BABCOCK BC-21 System Complete system: \$39.95

- The lowest priced interference-free single channel system on the market today.
- Provides selective rudder plus up-elevator from a single escapement.
- Designed for the smaller models, but adequate up to .15 size.
- Complete system includes transmitter, receiver, escapement, battery clip and switch panel.



### The BABCOCK BC-22 System Complete system: \$59.95

- Provides proportional rudder-only control from an exclusive new magnetic actuator design.
- Right and left buttons for "full-response" rudder-only stunting.
- Designed for models up to .07.
- Complete system includes transmitter (built-in pulser), receiver, PA-9 proportional actuator, battery and switch panel.



### The BABCOCK '27' System Complete system: \$79.95

- The maximum amount of control available to the single channel flyer. Provides selective rudder, selective elevator, plus motor control.
- Pilot stick control eliminates push-button flying.
- Completely pre-wired and cabled, and includes torque rods in place and stubbed out. Universal joint couplers provide "bind-free" torque rod operation.



- ✓ Standard 9-volt transistor radio batteries used throughout
- ✓ A new concept in superregenerative receivers — interference immunity from Citizens Band operation due to the extremely high selective audio frequency of 6000 cycles
- ✓ No FCC license required . . . you save \$8.

### SPORT FLYERS SPECIAL! LIMITED TIME ONLY **FREE COX .020 ENGINE AND FULL SIZE D.Q.A. 704 PLANS WITH ANY SYSTEM PURCHASED**

A DRY-CELL BATTERY CHARGER FOR CHARGING THE 9-VOLT TRANSISTOR RADIO BATTERIES USED IN THE BC-21, BC-22, AND '27' SYSTEMS PROVIDES UP TO TEN TIMES NORMAL BATTERY LIFE.

— \$4.95

**ACT NOW! Offer Is Limited!**  
Send cash, check or money order.  
California residents add 4% tax.

**BABCOCK CONTROLS INC.**

P. O. Box 666

Laguna Beach, Calif. 92652

*(Continued from Preceding Page)*

Possibly this made Gary a little over confident in crossing wakes. As he attempted to cross what he considered a small wake, the prop began to cavitate, and, due to the weeds on the propeller, he could not stop the cavitation and accidentally killed the engine! The unhappy part about it was that he was less than 7 miles from completing a round trip, and in spite of his reduced speed, he still had plenty of fuel left for the remaining distance. He returned home that day disappointed in not completing the round trip run but at least satisfied that someone had finally set a point to point run in the IMPBA record book. It may not be spectacular in distance, but at least it's a mark to shoot at in the future. He has about 50 feet of movie film of his run and lots of determination left for the next run.

This is just an example of the new and interesting things you can do with a model boat. Who says you've got to run around in circles all by yourself? Let your imagination run away with you and there's no limit to the amount of fun you can have. Let us hear from you about your brainstorm, that's what the IMPBA is for!

New Records		All ¼ mile oval	
C-2	Lee Pender	0:44.6	20.01 mph
D-2	R. Voelker	0:40.5	22.22 mph
F-1	C. Preusse	0:49.0	18.4 mph
F-2	E. Mundt	0:33.8	26.6 mph

### FIBREGLASS

*(Continued from Page 55)*

Wait for the mold to harden before releasing it from the "plug." While you are waiting, prepare a ¾ inch plywood frame to support your female mold. The frame will make the mold stable when you are working with it, and will prevent it from becoming distorted.

Now you have all but finished your production mold. Release it from the "plug" by wedging it up with pine splints all around the outside. It should then break free with a satisfying "pop." All that's left to do now is screw it into the frame. (Photograph 3.)

#### Joining Fuselages

The female mold should be silken smooth. This is accomplished with fine wet paper and Brasso. Wax the mold and polish it 5 times. If your surface is smooth and polished enough, it will not be necessary to use P.V.A. The gel-coat for the fuselage may be colored — preferably a light color to contrast with the dark female mold. (Sky blue was used for the Tempest.) It should be sprayed on for a light, even coverage.

Lay in a half thickness of 1½ oz. mat. It should be possible to do it with one sheet. Once it is wetted with resin, you

will not have any trouble making the mat conform to the shape of the mold with roller and brush. Be sure to get all the air bubbles out. When it hardens to a "cheesy" consistency, trim the edge with a sharp knife. Reinforce the nose and wing area with a second application of half thickness mat, and trim. Incidentally, have a quart can half filled with acetone (with a lid) handy in which to dunk your brush and

*(Continued on Page 60)*

### N.M.P.R.A.

*(Continued from Page 43)*

for the competitive spirit and enthusiasm was at an all-time high, with many newcomers entering competition for the first time and discovering that it was one of the most enjoyable aspects of our hobby — when an equal chance is afforded to all.

Send your cards and letters to the N.M.P.R.A., c/o R/C Modeler Magazine P.O. Box 487, Sierra Madre, California, concerning your views and comments on making the Goodyear event the type of event **you** want. And, if you are not an N.M.P.R.A. member — join today, and help make this new event one of the best R/C has to offer!



YOUR FLIGHT

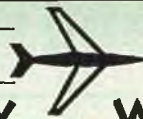

IS ONLY AS TRUE AS YOUR WING

USE **HAPPY WING** CORES — and be sure

TYPES — Include Instructions, Precut Dihedral Angle, Servo and Dihedral Brace Cutouts

BEACHCOMBER	CRUSADER	INTERCEPTOR	CANDY	\$ 15 <sup>00</sup>
BOSCH TAPER	KWIK-FLI	TAURUS	ROBIN	
SWEPT TAURUS	KWIK-FLI II	CITRON	VIPER	
L.G. Mounts Included with Above				

FALCON SR.	JENNY	*ARISTO-CAT	\$ 12 <sup>00</sup>
*FALCON 56	STORMER	*No Servo Cutout Unless Requested	

MATCHING STAB CORES (Except Robin & Viper) \$ 4<sup>75</sup>

IMPROVED "KWIK STICK" Foam-Balsa Contact Cement. Pt. \$2.50

We highly recommend GLAS KRAFT fuselages as a perfect mate for our Robin, Candy & Viper wings. SEND CHECK OR MONEY ORDER WE PAY POSTAGE

Satisfaction Guaranteed

CUSTOM PRODUCTS

1205 green acres rd. ph. 504-835-7447



metairie, louisiana zip code 70003

Jim Kirkland Stan John Bob Lien Les Sanborn

## FIBREGLASS

(Continued from Page 58)

roller between layers, otherwise they will harden and be useless. You should be able to reproduce both fuselage halves in an evening.

### Joining the Halves

Inasmuch as your original plug was made in one piece, the edges of the two halves should meet perfectly with little need for trimming. They should be fitted together with fibreglass tape on the inside and epoxied.

To make a rigid tape, roll resin into a 4 inch strip of fibreglass cloth the same length as your fuselage. This can be done on a waxed piece of masonite or glass. When "cheesy," cut straight strips tapering from 1 inch to 1/2 inch wide. (The narrow end will be at the tail end.) After sanding the strips to a rough surface—this is important—epoxy a strip on the inside of one fuselage half at the top, and another on the bottom. Half the width of the strips should protrude to be fitted into the other fuselage half when the epoxy has hardened.

Before joining and epoxying the two halves, be sure they fit easily, and if necessary (as it was with the Tempest), drill for small self-tapping screws

to hold the halves in place while the epoxy hardens. This will prevent twisting. The holes and the joint should be filled with epoxy glue, then sanded to give a strong, smooth, hidden seam.

Two or three bulkheads are all that will be necessary. Cardboard dummies should be fitted to determine the shape for permanent 1/8 inch plywood bulkheads. I used a 5/16 mahogany firewall and installed a Merco 61 on a Tatone mount. Fibreglass cloth wetted with epoxy was used to anchor it in place. The thrust line can be adjusted before the epoxy hardens. An alternate method would be to fit conventional hardwood motor rails in place. Spruce servo rails are fitted and epoxied to the fuselage sides. To total weight of the Tempest fuselage including engine mounts, bulkheads, and tailwheel was 18 oz.

Finishing with Hobby Pox or dope should be done only after fine sandpapering. Colored dope will adhere if clear is sprayed on first.

### Summary

The various stages of the project are illustrated in photograph 4, and are detailed as follows:

#### A. The Mold

1. Carve and finish a "plug" or master mold from 2 halves dowelled together.
2. Mount them on 2 plywood planks

and paint with Hobby Pox (white).

3. Polish with Brasso and then wax and polish 5 times.
4. Spray or brush dark-colored gel-coat.
5. Apply split (1/2 thickness) 1 1/2 oz. mat with polyester resin and trim, when "cheesy," to give 1 inch flange.
6. Apply 2 layers of full thickness mat and trim when "cheesy."
7. Release all around with pine splints and mount in frame.

#### B. The Fuselage

1. Wet paper and Brasso the female mold. Wax and polish 5 times.
2. Spray in light colored gel-coat.
3. Apply 1/2 thickness of 1 1/2 oz. mat and trim. Add 1/2 thickness reinforcing to nose and wing areas, and trim.
4. Make rigid tape and epoxy to edge of first half, let harden.
5. Fit second half and drill for self-tapping screws before gluing 2 halves.
6. After 2 halves are joined and epoxy has hardened, take out self-tapping screws. Fill holes and seams with epoxy to be sanded when hardened.
7. Fit bulkheads, motor mount, and servo rails, then epoxy to finished fuselage.

**NOW, 24 HOUR ASSEMBLY!**

COMPLETE CONTROLS!  
Rudder, Elevator,  
Ailerons and Engine.  
Wing Span: 57"  
Wing Area: 620 sq. in.  
Wght.: 5 lbs.

COMPLETE KIT  
only \$16.95



.19 to .45  
Engines

2 or 3 wheel  
landing gear!

SINGLE TO MULTI CHANNEL RADIOS!

TAKE A GOOD  
LOOK AT

"JENNY"

THE NEW LIVEWIRE!

Versatile!

Use the "JENNY"  
for . . .

TRAINING!  
ACROBATICS!  
CONTESTS!  
COMBAT!

and considerable FUN!  
SEND FOR COMPLETE DETAILS!

New Type Kit!

Assemble the "Jenny"  
.. Like a plastic model  
from completely finished parts, even the plywood fuselage! Kit has many unusual features plus all the bits and pieces required.

deBOLT MODEL ENG. CO.

3833 HARLEM RD  
BUFFALO 15, N. Y. U. S. A.



## WYANDOTTE STORY

(Continued from Page 6)

quite high among the finalists, and is quite a sight to see Bill Bertrand and his Tin Lizzy, along with Walt George and other members taxiing their multi planes down Fort Street amid the blare of the High School bands. Other members distribute gliders along the way, adding to the excitement of the younger spectators. The I.C.R.C.C. also maintains a demonstration team which is always ready and willing to fly at any civic event, having flown countless such demonstrations for various groups over the past years.

The present flying site for the Wyandotte club is a new and modern field a few miles from the center of town, equipped with parking areas and restraining limits for the hundreds of spectators who gather each weekend to watch the R/C activities. Their Annual Meet, however, is the highlight of the year, attracting contestants from all parts of the United States. Ed Kazmirski, Tom Brett, Hal deBolt, Tom Dion, and many other prominent flyers gather each year to enjoy a fun filled weekend, along with taking home the many prizes and awards. Club contests are held on a monthly basis and the competition becomes tougher every year. The Annual Banquet is a family program where trophies are awarded for the Best Flyer, Most Improved Flyer, and Outstanding Club Member.

The Indian City group is composed predominantly of multi fliers, although they still have their share of rudder, intermediate, and scale enthusiasts. The trend is towards proportional equipment and the new Goodyear pylon racers. With an entire membership building Goodyear ships, the Michigan club can expect some exciting and crowd-pleasing afternoons this coming season.

A training program has also been developed for the junior flyers, and it's quite refreshing to see them give the "old men" a rough time at many of the contests.

Public relations have never been better and the Indian City Club has a long waiting list of prospective members who have developed an interest in the hobby through watching the weekend flying activities. A great percentage of this success story can be attributed to a well-balanced program with a multiplicity of interests. Combine this with their never-ending program of sharing their activities with their families and community, and it becomes self-evident why the history of the Wyandotte club is a tribute to its individual members for their contribution to the overall picture of model aviation.

The Indian City Radio Control Club — RCM salutes you.



Hal de Bolt and Interceptor. First in Multi expert at Indian City meet.



Lee Pennington, club contest director with Senior Falcon. Sampey Proportional.



Keith Finkbeiner of Toledo Weak Signals, second in novice multi at I.C.R.C.C. meet.



# SK DADDLE TOO

27½" long • 10½" beam . . . \$9.95

LIKE MORE SPEED? try the SK• DADDLE

36" long • 14" beam . . . \$21.95

**EASY TO BUILD**  
2 Brand New Models



## DUMAS

featuring the "hot ones"  
designed for "go" . . . ideal for show

## BOATS

P.O. Box 6093 • TUCSON, ARIZONA 85716 • dept R25

with water proof compartments  
for radio control

horsepower, only  
Lloyds of London  
will insure the SK's

- ★ All die-cut mahogany & mahogany plywood.
- ★ For .15-.19 cu. in. engine
- ★ Birch plywood construction
- ★ All pre-cut parts
- ★ For .29-.60 cu. in. engine
- ★ WRITE FOR FREE CATALOG . . . over 30 boats to choose from — including the Historic PT 109 and the Gold Cup Hydroplanes

satisfaction  
guaranteed.  
immediate  
delivery

dealer inquiries  
invited

## TOP OUT

(Continued from Page 52)

been made lately to ask RCers to take on the task. I'm sure "LA" would be glad to hear from those interested in joining with him and Dick Straw of Tyler, Texas (Dick also officiated at the 64 and 65 Nats) in promoting the idea to the AMA and the directors of the next Nats. Perhaps paid transportation could be made to encourage competent officiating. Why not?

Another possibility for more flights is to finalize action on rearranging the maneuver lists to take advantage of current capabilities and reduce time allotted for each flight. This has been kicked around for a long while and it's time action was taken. With the advent of new frequencies there's no need to limit ourselves to only four flight lines either. Goodyear, Pylon, and Scale could be assigned their own frequencies and proceed alone at a separate site without stopping Pattern flying.

Regarding a single flight line for class I, Johnston pointed out that it's an easy matter—all simply register for the same frequency! While a single frequency was intended in the original suggestion, it was desired that the decision to al-

locate a frequency for class I be made by the event director. However, unless one is made it may be a good idea for class I fliers to follow Johnston's suggestion and decide the matter themselves. How 'bout 27.145, OK?

## TOURNAMENT OF CHAMPIONS

Following on the heels of the TORKS annual contest in Oklahoma City was a second major contest, the 1965 INTERNATIONAL RC MODEL AIRPLANE TOURNAMENT OF CHAMPIONS. This was an invitational affair which brought together the top fliers for the year to match talent and technique for some mighty handsome trophies as well as respectable hunks of cash and merchandise. Because of the significance of many aspects of this annual meet a full account is presented. This was the second year for well known Maurice Woods to host the meet and it looks to have a promising and exciting future:

The 1965 INTERNATIONAL RADIO-CONTROLLED MODEL AIRPLANE TOURNAMENT OF CHAMPIONS field of fliers consisted of representation from the four corners of the United States and included the following:

- Howard Bonner — Los Angeles, Cal.
- Dr. Ralph Brooke — Seattle, Wash.
- Harold DeBolt — Buffalo, N. Y.
- Jimmy Greer — Chicago, Ill.
- Maxy Hester — Des Moines, Iowa

- John & Robbie Kelley — Denver, Colo.
- Jim Kirkland — Valpariso, Fla.
- Phil Kraft — El Monte, Cal.
- Byron Lakin — Springfield, Mo.
- Randy McGee — Oklahoma City, Okla.
- Dale Nutter — Tulsa, Okla.
- Bill Powell — Cedar Rapids, Iowa
- Al Solnok — Tulsa, Okla.
- Loren Tregellas — Wichita, Kan.
- Cliff Weirick — Los Angeles, Cal.
- Ted White — Albuquerque, N. M.

THE FIRST DAY, FRIDAY 24 SEPTEMBER. . . . When the meet opened at 9 a.m. the weather was a cold 48°; cloudy but windless. It finally warmed to 59°, a record low. Since everyone had been used to warm weather contestants were chilled all day. Cliff Weirick and Phil Kraft came prepared with jackets while others took pot luck with sweaters, etc. supplied by tournament host Maurice Woods. Coffee was brewed and several gallons warmed fliers and officials through the day. Contestants competed in alphabetical order with Dr. Brooke leading off. On this first flight he used the plane with which he had won the 1965 International RC title in Sweden. The pattern was a standard AMA sequence except that horizontal 8's were deleted and three free style optional maneuvers could be inserted after the spin. Doc

(Continued on Page 64)



## NEW READY TO FLY TRAINER FOR THOSE NEW IN R/C

### TO FLY YOU:

- 1 — Glue Precut Wing Halves Together.
- 2 — Mount Tail Surfaces.
- 3 — Attach Control Surfaces.
- 4 — Install Engine and Equipment.

WING SPAN 65"

AREA 525 □"

EMPTY WEIGHT 2 LBS. 14 OZ.



\$37.95

## TRANSIT — TRANSITION TRAINER

Flys with 6 channel or 3+1 — Controls are rudder, elevator and motor — No ailerons. Recommended engine size .35 or .45.

## DELUX MUSTANG

READY TO FLY!

KIT NOW INCLUDES:

Formed Canopy and Windshield  
 . . . Epoxy Glue . . . Nylon Hinges . . . Control Horns  
 . . . Bellcranks . . . Nose Gear Steering Arm.

FLYS ON RUDDER, ELEVATOR, AND TRIM.

EMPTY WEIGHT 2½ LBS.

65" WING SPAN.



\$34.95

FOR ANY ENGINE .45 OR LARGER

AFTER 6 YEARS OF TESTING AND FLYING, ALL LANIER READY-TO-FLY MODELS FEATURE:

- AIR-O-FOAM WING AND STABILIZERS
- ALL SURFACES PRE-COVERED
- COMPLETELY FUEL PROOF — NO DOPING NECESSARY
- COMPLETELY WARP FREE AND NOT AFFECTED BY TEMPERATURE OR HUMIDITY
- FINISHED RUGGED FUSELAGE
- BUILT IN MOTOR MOUNTS
- PRE-FORMED MAIN AND NOSE GEAR
- ALL PARTS INTERCHANGEABLE AND CAN BE ORDERED SEPARATE
- AIR-O-SHEET EXTERIORS ARE SMOOTH, NON-POROUS, AND FUEL PROOF
- MODELS CAN BE TRIMMED WITH PLASTIC TAPE OR SPRAY PAINTED
- KITS INCLUDE EPOXY GLUE, FITTINGS, AND CONTROL BELCRANKS
- R/C COMPARTMENTS ARE LARGE ENOUGH TO ACCOMMODATE ANY OF THE EQUIPMENT ON THE MARKET TODAY
- ALL MODELS ARE MADE OF AIR-O-SHEET® WHICH IS A CUSTOM MADE THERMOPLASTIC MATERIAL ENGINEERED TO MEET THE NEEDS OF MODELING. AIR-O-SHEET IS A TOUGH PLIABLE MATERIAL THAT WILL SHATTER LIKE FIBERGLASS AND OTHER PLASTICS.

SEND CASH, CHECK, OR MONEY ORDER.  
 SHIPPING CHARGES ARE C.O.D.  
 DEALER INQUIRIES INVITED.

LOOK FOR NEXT MONTH'S  
 NEW DESIGN !!

## LANIER INDUSTRIES, INC.

880 DORSEY ST.  
 GAINESVILLE, GA.

PHONE  
 404-532-6401

## TOP OUT

(Continued from Page 62)

Brooke was on his second optional, a rolling 360° turn, was distracted a moment and then joined the up-elevator club! He demolished his ship and ruined the third Merco engine within 2½ months. Doc's good natured comment was that Mr. Merco was going to complain about such rough treatment of engines! Good sportsmanship credit went to Jimmy Greer for offering a plane to Ralph who used it for the remainder of the meet after agreement to allow a rules deviation was made. It was a tribute to Dr. Brooke's skill that he placed 4th in the final standings flying a completely strange airplane. Other first day casualties included Bryon Lakin who ran his pretty Taurus through high wires due to radio trouble. After flying, the day was ended at a hamburger fry at the home of Maurice Woods.

THE SECOND DAY, SATURDAY 25, SEPTEMBER. . . . The weather warmed a bit, clouds persisted, and the wind came up . . . still uncomfortable. Pattern flying continued from 9 a.m. til 12:30. After lunch there was a round of Goodyear Pylon racing. Instead of using the scale-beauty handicap point system, time handicaps were established based upon a ten lap qualifying

course everyone flew. The following entered: Weirick, Solnok, Nutter, White, Kirkland, Tregellas, Powell, DeBolt, and Woods. Qualifying started roughly. At the outset Woods' plane fail-safed at 300 feet down the course and glided in undamaged. It was found that the antenna had been bunched together in putting in the radio gear. Weirick's ship took off, went straight down the pylon course then unexplainedly rolled over and crashed. For the remainder of the contest Cliff flew the Long Midget that he and Maurice had teamed together on to win the 1965 National Championship in Philadelphia. The rest of the qualifying went smoothly and all times were tallied for handicapping the following day's finals. The rest of the afternoon was spent in pattern flying. That night all contestants and their families were guests at the Wedgewood Amusement Park, the tournament sponsor, where they were treated to an outdoor barbecue and an evening of amusement rides and go-karting. It was reported that it would have been difficult to describe the sight of Howard Bonner, cap on backwards ala Barney Oldfield, racing "Pappy" DeBolt around the go-kart track. It wasn't recorded who ended up karting champ but everyone got in a try, wives included.

THE THIRD DAY, SUNDAY 26

SEPTEMBER. . . . Flying consisted of the final round of pattern and Goodyear Pylon finals. Weather was beautiful, no wind, clear blue sky, and 80° temperature! Pylon racing was conducted on a 50% handicap basis as follows: total 10 lap time difference between two racers was halved and handicapped to the faster plane. It was believed this would result in closer races and performances more readily understandable to the large number of spectators who were on hand. Each time a racer flew the time was clocked and if less than the previous time the handicap was changed for the next heat. In the first round Loren Tregellas won and was awarded combination Thermos and sandwich container set — a procedure the ladies appreciated and had their husbands trying harder to win the appliances awarded in the semi-finals. The second round was open to any type airplane and four ships were raced simultaneously. Ted White handily won the round with Jim Kirkland second. The third round was a Goodyear event. White demolished his plane in this try, cause unknown. Kirkland topped the round with DeBolt second. Final event featured a 25 lap Goodyear with a mandatory pit stop and was won by Weirick and the Woods' Long Midget. In addition to the magnificent perpet-

(Continued on Page 66)



## TOP OUT

(Continued from Page 64)

ual trophy Cliff pocketed \$100 for his efforts. In second place Al Solnok won \$50, while third place honors and \$25 went to DeBolt. "Pappy" suggested a way to overcome the frequency limitation hampering Goodyear finals which was to have multiple frequency transmitters and receivers featuring 'switchability.' The 50% handicap system proved to be an equalizer and made the contest close and exciting for all. Maurice Woods' Midget set a record of 2:33 for ten laps as a bonus extra to all the other happenings. Bob Bennet of Wichita donated the perpetual Goodyear Racing Trophy which gives the Tournament of Champions two permanent trophies to bestow on winning pilots.

Pattern event standings ended up like this . . . Ted White, \$250 for 1st and the permanent Pattern Trophy; Phil Kraft, \$150 for 2nd place; Cliff Weirick, \$100 and 3rd place. Ralph Brooke and Jim Kirkland took 4th and 5th for \$75 and \$50 respectively.

Important help was given the meet by the Oklahoma RC Association and its many hard working members. The Oklahoma Aviation Commission, Mr. Irving Bollingbeck, Chairman, Mr. Keith Lutz, Executive Director, and Mr. Mack Braly, Publicity Director, contributed a great amount of effort in making the contest a success. They provided judges and judged part of the time themselves. Maurice Marris, Commander of the Oklahoma CAP, and many other luminaries in Oklahoma aviation assisted the judging. Special mention also went to Mr. Ted Zahn, chief of Tower Control at Tinker AFB for his much appreciated tournament assistance.

This was the second annual Tournament promoted by Maurice Woods at his Wedgewood Amusement Park and was a lot bigger and better than the first in 1964. Oklahoma City papers, radio, and TV gave wide coverage, far more than last year. An admission was charged this year and over 500 paid on Saturday and 700 on Sunday. Crowd size was impressive considering the newness of this type of activity in a commercial way. Hobby shops of Oklahoma City reported a significant upsurge of interest in RC gear and models since the tournament. Plans are underway to make 1966's affair even more successful than this last tournament.

### CONTEST TECHNIQUES

**WING OVER** - This maneuver begins the aerobic phase of the pattern and introduces a new basic factor which must be considered in doing every maneuver in this phase. This

(Continued on Page 68)

### 4 in 1 GASSER

- FILLS ITSELF
- FILLS AIRPLANE
- PRIMES AIRPLANE
- EXTRACTS GAS FROM TANK.
- FILTERS FUEL AS IT ENTERS TANK
- MANY OTHER USES

\$4.95

SEE YOUR DEALER  
OR ORDER DIRECT

CALIF. RESIDENTS  
ADD 4% SALES TAX

## 4 IN 1 GASSER

4152 NORSE WAY  
LONG BEACH, CALIFORNIA

### QUALITY R/C ACCESSORIES by DU-BRO

#### Du-Bro LINKAGE ARM

(FOR BONNER SERVOS)

Ideal set-up for nose wheel and rudder or engine control where less throw is needed. .050 steel.

only 49¢

Stock No. LA-3

#### Du-Bro DURA-CONNECTOR & V-LINK

For proportional sets using disc servos.

only 98¢

Stock No. DCL-2

#### Du-Bro DURA-COLLARS

Best collars available. Pugged cadmium plated brass. Threads will not strip. Complete with set screws and Allen wrench. Stronger than aluminum type.

4 FOR 59¢

#### Du-Bro TB-2-TRIM BAR

FOR BONNER SERVOS

Can be modified to Ancco servos. Designed for inline or side by side hook-up. Lightweight.

\$1.95

#### Du-Bro 6 SPOKE DURA-HUB WHEELS

Permanently pneumatic stronger unbreakable

2 1/4" (1 3/4 oz.)	\$2.59
2 1/2" (2 oz.)	2.79
2 3/4" (2 1/2 oz.)	2.99
3" (3 oz.)	3.19
3 1/4" (3 1/2 oz.)	3.39
3 1/2" (4 oz.)	3.59

#### SERVO MOUNTING HARDWARE PACK

BOLT (3 48)

WASHER

SPACER

BLIND MOUNTING NUT

SINGLE PACK 55¢

FIVE PACK \$2.39

Hardware for one servo. Stock No. SM 55. Packaged 12 to card.

Hardware for five servos. Stock No. SM 239. Packaged 3 to a card.

#### Du-Bro DUAL TAKE-OFF

FOR BONNER SERVOS

only 49¢

With a Du-Bro DURA-V-LINK it makes an ideal hook-up for dual or single take-offs. take-off from either end of servo. Brass.

Stock No. DT-4

#### Du-Bro DURA-V-LINK

CLOSE-UP OF CLEVIS

only 49¢

For use with Du-Bro DURA-CONNECTORS and Du-Bro DUAL TAKE-OFFS. Also ideal for other servos with eyelet style take-offs. Spring steel. Stock No. DVL-1

#### Du-Bro DURA-LINK GUARDS

For those who feel the necessity . . . a removable safety guard to "positive lock" all links.

4 FOR 10¢

Stock No. LG-10

#### The ORIGINAL Du-Bro KWIK-LINK

CONTROL YOKE ASSEMBLY . . . for any control linkage!

THE TOP QUALITY LINK

Split Coupling Sleeve

49¢

3/4" thread on 4" rod

Stock No. KL-49

MADE IN THE U.S.A.

#### Du-Bro POSITIVE ACTION WHEEL BRAKES

1/2 oz. each. Steel brake drum eliminates scoring. Spring steel control arm.

only \$7.95 pair

WHEELS NOT INCLUDED

#### Du-Bro BLIND MOUNTING NUTS

Can be used on 1/4" plywood (without sticking thru) and thicker.

EACH 20¢

4 per pkg. 3 thread sizes:

2-56 Stock No. BN256

3-48 Stock No. BN348

4-40 Stock No. BN440

**DU-BRO PRODUCTS • 7667 Milwaukee Avenue • Niles, Illinois 60648**



**FOX PROUDLY INTRODUCES A TRULY BETTER MULTI R/C ENGINE**

**WHY IT IS BETTER**

- 1** Reliability is knowing just exactly what your motor is going to do flight after flight — month after month. Unreliability comes from wear; excessive vibration; inadequate cooling and structural weakness. The new Fox 60 R/C is reliable to a degree never before known to model flyers.
- 2** Performance is the capability to fly your airplane anywhere, anytime, thru any maneuver and know beyond a reasonable doubt you can get it back to your landing strip. The Fox 60 R/C has this capability.
- 3** You get Gold Plated Service. A Rolls Royce is no good if you can't get a fan belt. If you have a crash — need a part — or have a problem, call Duke Fox direct.

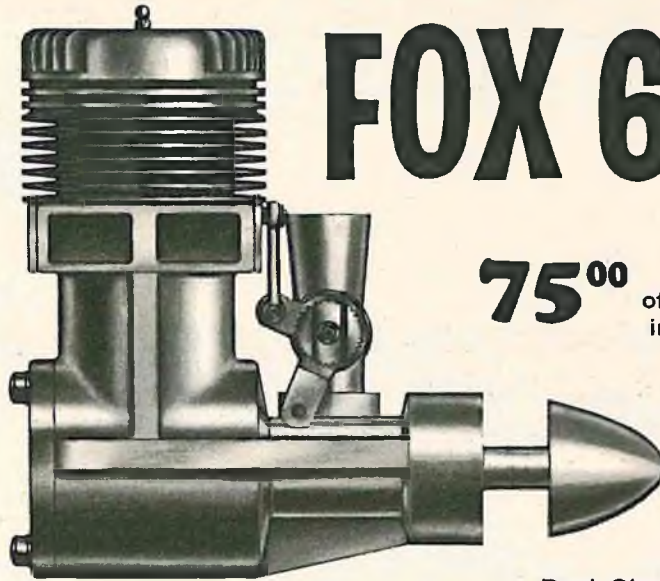

# FOX 60 R/C

**75<sup>00</sup>**

A LIMITED NUMBER of these will be available in the month of January.

Tell your dealer these motors will be shipped on a first come-first served basis.

**SPECIFICATIONS:**

BORE .....907  
 STROKE .....937  
 DISP. ....60  
 RPM....1,800 to 14,000  
           with 11-7 Prop  
 HP ..... .9 with Alcohol  
           1.3 with 25% Nitro  
 MUFFLER-  
 OPTIONAL-EXTRA COST

- Dual Glow Plugs
- Dual Ball Bearings on Crank
- Dual Needle Bearings on Rod
- Cylinder — Nitrided Steel
- Piston — Cast Aluminum. 2 Rings
- Carburetor—Improved Triple Jet Single Barrel Injection Type. All Jets and Idle Stop Adjustable While Motor Is Running
- Factory Run-In of One Hour Prior to Final Adjustments and Check for Full RPM and Freedom from Seizing Tendencies.

**duke's mixture**

Short month — short column:  
 Congratulations to Craig Bankemper of Cincinnati for winning 1st Place Stunt at Cleveland. Craig is only 11. Power — Fox 35. Here is a boy to watch.

Bonanza still waiting for new crankcase. Jess, the mechanic doing the work, said he wanted to get me back in the air before I forgot how to fly — but he thought it would be underpowered with a Fox Motor.

Strange array of parts now seen around shop — gas caps for tractors — wheel nuts for hot rods — spindle shafts for cotton pickers — release buttons for bombs. Honest dollar, you know — but make no mistake — model airplanes are my first love and major source of income.

I have always wanted a properly planned Log Book to record my model flights in. After 30 years, I finally got around to designing and printing one. Has columns for date, airplane engine, fuel, plug, temp, humidity, flight duration and remarks. Also speed chart — engine tips, etc. Send 25c for mailing and handling, or if you have logged over 20 flights on one Fox Plug, tell me how many and I will pay the postage.

Hal Redner sent me nice picture of lawnmower with Fox Superfuel can strapped to engine. Notation on rear — when last seen was at 3,000 feet and climbing.

Surprise of the Month — Unexpected surge of R/C Plug sales explained when found combat flyers are using them to eliminate engine's tendency to cut on sharp maneuvers.



## FOX 40

The most successful Rat Race motor ever produced. Improved for 1966 featuring a big 19/32 shaft. Wrist pin keepers and a host of other refinements.

**27<sup>50</sup>** ● Faster Acceleration  
 ● More Speed  
 ● Better Fuel Economy

This year's NATS Winners:

- 1st — NATS Open — John McCollum
- 1st — NATS Sr. — Thomas Stucker
- 2nd — NATS Jr. — Larry Newman



## FOX 35 STUNT

**16<sup>95</sup>**

The world's most successful stunt motor now in its 17th year of continuous production. 1st Place Stunt Winner every Nationals since its introduction.

This year's NATS Winners:

- Dawn Casmillo — Jr. Stunt
- Gerry Cipra — Sr. Stunt



**FOX MANUFACTURING COMPANY**  
 FORT SMITH, ARKANSAS

### FOX FUELS



**FOX SUPERFUEL** — The oiliest fuel available  
 20% Oil 5% Nitro Pt. 95c Qt. \$1.69 Gal. \$5.50

**DUKE'S FUEL** — Especially compounded for R/C engine  
 Low residue, idle additives 15% Nitro Gal. \$5.50

**MISSILE MIST** — The high performance fuel  
 25% Nitro Pt. 95c Qt. \$1.69 Gal. \$5.50

**BLAST** — The highest performance non-critical fuel  
 available 50% Nitro \$1.50 Pt.

### FOX GLO PLUGS



The Glow Tells the Story — Light up a Fox Glo Plug — Now check any other glow plug. Notice the brighter Fox glow . . . This is why Fox Glo Plugs start quicker and run faster.

FOX STANDARD SHORT..... 49c  
 FOX STANDARD LONG..... 49c  
 FOX HEAVY DUTY LONG..... 75c  
 FOX R/C SHORT..... 98c  
 FOX R/C LONG..... 98c





# DEALERS.....

We are exclusive distributors for the new KWIK-FLI II by Jensen Enterprises. Designed and approved by Phil Kraft.

We are also distributors for a good line of imported scale control line and R/C kits. Send for list of kits available.

## NEMO HOBBY DISTRIBUTORS

4720-22 Peck Rd. • El Monte, California 91732 • (213) GI 8-8913

## TOP OUT

(Continued from Page 66)



Jackie Gardner, Jackson, Miss., rudder fan, displays Nats Class I trophy — ship that he won it with.

factor involves air-space positioning. Until now there wasn't much latitude in selecting where you placed your ship — now it becomes real important to place maneuvers where they may be done best, show best, and be strung together for best flight time and pattern efficiency. Sometimes these are contradictory requirements and hamper good scoring. Where this contradiction exists scores will depend heavily on how well the particular problem is solved. The best place to perform maneuvers is against a northern sky, that is, with your back to the sun and the plane in the north half of the sky. (For those of you below the equator, naturally the opposite is true and the southern sky is most desirable.) However, time limits, other planes in the air, the wind (speed and direction), spectator location, size of space required to do a maneuver, and field obstacles or limits may work against the ideal of using the desired part of the sky — the part that has least glare and reflection and is pleasantest to look into. Be sure to recognize this positioning goal and apply it as much as possible — don't be satisfied to let positioning be uncontrolled, judges have been known to score goose eggs when a ship is in an awkward position or in the sun. With these thoughts in mind let's proceed with the wing over.

After completing the Touch and Go (RCM Dec. 1965), climb the ship around in minimum time thru a 360° turn and one that'll allow it to reach an altitude of 75 to 100 feet at a position 50 to 75 feet upwind of the transmitter. It's recommended that the maneuver normally be started into the wind from this position. As the plane reaches the desired spot at full throttle, make sure the heading is straight into the wind with wings level. Now chop the throttle all the way. (This is a handy signal to designate the start of

(Continued on Page 70)

Another **ai** First!

N.M.P.R.A. APPROVED

THE AEOLUS

GOOD YEAR

**PYLON RACER**

**Fiberglass Fuse**

The AEOLUS, Designed by DICK RIGGS

Now — save half the time in building your own, beautiful fiberglass AEOLUS — a top Good Year performer. Complete with fiberglass fuse, high-impact plastic cheek cowls and wheel pants, full plans.

**\$28<sup>50</sup>**

Dealer Inquiries Invited!

Fuse \$24.95      **FIBERGLASS SR. FALCON**  
 Kit \$36.95      Fiberglass fuse more rounded than original Sr. Falcon Kit. Motor bearers molded in for 6 to 10 channels or proportioned, and 35-45 engines.

**ACTION INDUSTRIES, INC.**  
 4125 Reisterstown Rd.  
 Baltimore, Md. 21215

Aeolus Fiberglass Fuse (\$28.50)  
 Sr. Falcon Fiberglass Fuse (\$24.95)  
 Sr. Falcon Fiberglass Kit (\$36.95)

NAME \_\_\_\_\_  
 ADDRESS \_\_\_\_\_  
 CITY & STATE \_\_\_\_\_  
 (Maryland Residents Add 3% Sales Tax)

**ACTION INDUSTRIES, INC.**  
 4125 Reisterstown Rd.  
 Baltimore, Md. 21215





# CHALLENGER

JOHN ROHRBACH of SCHUYLKILL HAVEN, PA.

WITH HIS PRIZE WINNING CHALLENGER

ALL 1ST PLACES

CLASS II COMPETITION  
D-B QUADRUPLEX  
RADIO - 1965 NAT.  
CAPITOL CHAMP

## NEW PRICES

CHALLENGER - \$21.95

CHEROKEE - \$25.95



### VK MODEL AIRCRAFT CO.

4350 ARONDALE DR.,  
WILLIAMSVILLE, N. Y. 14221

## SCALE AIRCRAFT DRAWINGS FROM "THE GOLDEN AGE OF AIR RACING"

PRE 1940 THOMPSON, BENDIX AND GREVE TROPHY RACERS  
- DRAWN TO LARGE SCALES FOR R/C MODELING

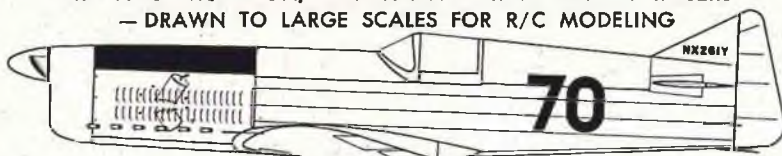

AT SCALE 3" = 1'-0"  
SCHOENFELDT FIRECRACKER  
BROWN B-2 "MISS LOS ANGELES"  
ART CHESTER'S "JEEP"  
3 1/2 FT. X 6 FT. PLAN

AT SCALE 2" = 1'-0"  
HOWARD "MR. MULLIGAN"  
COL. TURNER'S PESCO SPECIAL  
LAIRD SOLUTION  
\$4.00 PER PLAN

WING SPANS RUN 50" TO 63" - AREAS RUN 450 TO 550 SQUARE IN.

H. A. OSBORNE, 1932 CONEJO LN., FULLERTON, CALIF.

**WHAT DO YOU NEED** \_\_\_\_\_  
 A WORK-BOARD WITH PINS & NEEDLES  
 or A RELIABLE, AUTHENTIC TYPE WING-JIG ?

The BROADFIELD "UNI-WING-A-JIG" was DESIGNED to meet YOUR REQUIREMENTS for a FASTER, MORE EXACT METHOD OF BUILDING; IT'S THE UTMOST in wing jig BUILDING-SYSTEMS.

UNI-JIG sets up IN MINUTES. it's COMPLETELY ADJUSTABLE; it BUILDS all leading R/C wings and stabilizers. MORE THAN 100 UNIQUELY DESIGNED JIG-PARTS (slot-lock) to SECURELY ALIGN (L/T edges) with RIBS; RIB-HOLDERS set in ALUMINUM CHANNELS in ANY desired SPACING.

CAPACITY: 72" SPAN 12" CHORD - plus HINGED for ANY degree DIHEDRAL. SETS UP for TAPERED or CONSTANT-CHORD wings. It's been tried and tested by many well-known radio-control modelers.

DUPLICATION of SPARE WING or STAB. in any SET-UP is FAST and ACCURATE.

JIG-COMPONENTS PRECISION (SAW-CUT) to SIZE; birch plywood (L/T edge) supporters; bass-wood drilled & notched cross-members, 4-36" L. aluminum channels.

\* ASK YOUR DEALER or ORDER DIRECT \*

UNI-WING-A-JIG (UN72) with extra stab. parts - \$21.95  
 BROADFIELD AIR-MODELS ASHLAND, MASS. 01721 U.S.A.



"Wouldnt you rather have a "Uni-Jig"?"

UNI-WING-A-JIG \$21.95

## TOP OUT

(Continued from Page 68)

maneuvers.) As the ship dips keep it straight and level and just before the bottom of the dip is reached feed full throttle back in. With this 'bouncing' up the plane should sweep up to a vertical position - play the power a mite if need be to prevent a reflexing past vertical. Be sure, also, at this point that the wings are parallel with the ground. Just before the stall, feed in a tap of right rudder (we're going to hammer-head stall - that is, a flat stalled turn rotating in the plane of the wings while the ship's vertical). As the nose rotates to the right - the recommended anti-spin direction - and just as the ship stops its climb, feed in a second right turn signal - this one a speck longer than the first. Continue the flat turn with added taps of right if needed but don't make too many at once if you want to keep the turn flat and at a slow, constant rate. The turn may be stopped with a tap of left, or if you've hit the right right, the ship'll stop by itself after 180° of turn. In any case, 180° is what's wanted so that the ship is now headed down starting on a pull-out opposite to the direction of the pull-up. At this point chop the throttle again since a speed build-up is not desired. Maintain direction by keeping the wings straight and level as the ship pulls through down-wind. Keep the power off until the momentum plays out, then feed in about quarter power to prevent scalloping. The ship is now almost positioned for the next maneuver which will be the Barrel Rolls. We'll focus in on that one next time. . . .

Rogers Barton, Corpus Christi, Texas, school official, sights adjustment into his well known Zeus. Ancco servos, ST 40 and Orbit 10 channel radio complete this red and black class I beauty.



## PROPORTIONAL HEADQUARTERS!

(Export Wholesale only)

Babcock  
 Bonner Digimite  
 C&S Digicon II.  
 Citizen-Ship Analog  
 Controlaire  
 Dee Bee Quadruplex CL-5 & 21

E.K. Logictrol  
 F&M Digital-5  
 Kraft Custom KP-4  
 Micro Avionics  
 Orbit Quad Analog & 3+1  
 R/C Modeler Digitrio

And more coming!

## EXPORTATIONS

(Now ready to serve you even better  
in our new larger quarters)

2137 N. Marianna Ave.

Los Angeles, Calif. 90032

Tel. (213) 221-6968, Cable: Extronic



# UNIQUE



## The Early Bird

This is an excellent multi-trainer that flies well on rudder and elevator or multi-channel. A complete prefab kit suited for beginners or professionals.

Wing span 62"

Wing area 710 Sq. In.

Length 47"

Engine .45 to .60

Approx. flying wt. 6 lbs. 2 oz.

**\$44.95**

### CHECK THESE QUALITY FEATURES

- ✓ FUSELAGE - Made of high impact Duranite.
- ✓ Fully assembled.
- ✓ Completely fuel proof.
- ✓ Room for any multi-channel equipment made.
- ✓ Exceptionally rugged.
- ✓ WING, STAB AND RUDDER made of foam for trueness and FULLY covered.
- ✓ Pre-fitted at factory.
- ✓ Unique nylon wing and stab hold downs.
- ✓ No rubberbands necessary.
- ✓ All necessary hardware.
- ✓ Pre-bent landing gear.
- ✓ Fully flight tested.

All these features apply to El Tigre and Early Bird

## El Tigre

- This is a full sized multi-channel airplane. Complete prefab kit with landing gear, hinge material and canopy. Fuselage fully assembled at factory.

Wing span 66"

Wing area 735 Sq. In.

Length 46"

Engine .56 to .61

Approx. flying wt. 6½ lbs.

**\$54.95**

**DURANITE** Sheeting kit  
65" x 33" sheet of duranite complete with glue and instructions. Sufficient sheeting for the average multi airplane's wing, rudder and stab. **12.95**

### WHEEL PANTS



2.95 per pair

Light weight (one oz. per pant), rugged and fully assembled. Only light sanding and painting required. Mounting plate, screws and complete instructions furnished. 3 sizes to choose from, 7¼", 7½", 9¼". Please state which size. All will accommodate 3¼" wheels.

Package of 5 Nylon replacement screws  
1" x 10 - 24  
**98c**

Sorry no C.O.D.'s. Send check or money order. New Mexico residents add 4% sales tax.



7521 Menaul, N.E. • Albuquerque, New Mexico

Available at your local dealer or order direct

We wish to take this space to thank our many customers for their calls, letters and telegrams complimenting us on our airplane and accessories.

It gives us much satisfaction to know that in this day and time, detailed craftsmanship does not go unnoticed. We have appreciated your patronage and we will assure you as each new product is developed we will uphold the same high quality that you have put your trust in, the name Woodcraft.

## WATCH FOR THE RCM ANNUAL! ON SALE FEBRUARY 1966

### EDITOR'S MEMO

(Continued from Page 12)

my wife's grocery money to buy fuel for my ½A.

Later, I will probably write again just to tell you how many years I'll be in the pen for hocking my mortgaged car in order to buy some of that exotic

R/C equipment you advertise. Keep up the great work of making me miserable, you bums!

— Lester Beason

You can't get rid of me that easy. I just remembered a note that Carl Goldberg wanted passed on to youse guys that are building the Shoestring, featured in last month's issue.

The wing breakaway plate as shown on the plan is ½" wide and will break in the vicinity of 45 pounds of pull. This amounts to around 11 G's. However, since it has been pointed out that some fellows may produce far higher G's

than contemplated by running the ship faster and making sharper pullouts, it may be advisable to provide for a higher breaking load. Accordingly, Carl recommends that the breakaway plate go up to 1". Since the holes remain the same, the breaking load with the larger plate goes up to approximately 105 pounds, according to test results. This is better than 25 G's, dad, and if you need more than that, forget it. By the way, the cross member which is ¼" x ½" basswood, should be changed to ⅝" x ¾" birch. Okay?

Yours truly, Fearless Leader.



## THE LAST WORD

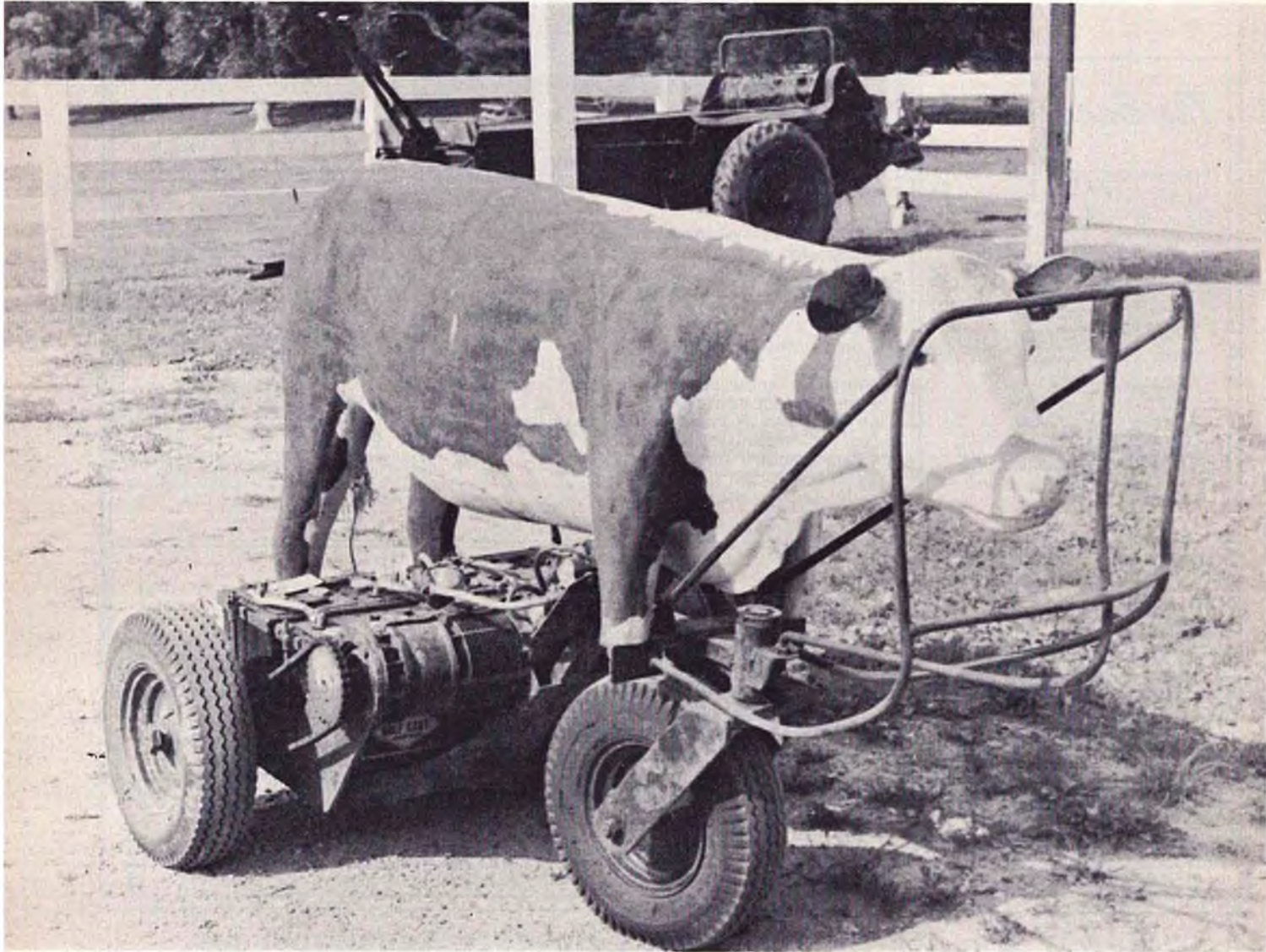

### **RADIO CONTROLLED CALF TRAINS HORSES . . .**

The fibreglass calf, mounted on a golf chassis, is controlled by four channel radio. The "left" control operates an auto type starter solenoid switch that reverses the left drive motor, making the calf spin around in its own length. "High" control puts 12 volts on each motor for a fast run. A drive motor is used for each rear wheel. An oversized toy? Not at all. The "calf" is used for training horses to cut the calves out of the herd at the Del-Jay Farm in Gates Mills, Ohio.

Photo by Bob Penko.