

FREE FULL SIZE PLAN FOR THE DQA-704

CDC

radio control

DECEMBER 1964 50¢

Modeler

AMERICA'S LEADING PUBLICATION FOR THE WORLD'S FASTEST GROWING HOBBY



THE DIGESTER AND D.Q.A. 704

SPECIAL 'AGE OF PROPORTIONAL' ISSUE

The AGE OF PROPORTIONAL Issue

- 10 The Age Of Proportional: Realism** *Al Doig*
Is it here, or isn't it? An introduction to a new era in radio control.

- 17 The D.Q.A. 704 — The First Step**
Full size plans for a 32" span model for proportional rudder only.

- 23 The Digester: Proportional Trainer** *D. B. Mathes*
A six foot span trainer for quad proportional systems. Capable of entire A.M.A. pattern.

- 29 The Age Of Proportional** *Malcolm Davis*
Retractable gear, flaps, plus mixture control: How to utilize the extra proportional channels.

- 33 The Age Of Proportional: The New Systems**
RCM reviews the Babcock BC-22, Min-X Pulsmite 1200, and Kraft quad proportional — proportional flying in three different categories.

MONTHLY FEATURES

| | | | |
|-----------------------------|-----------|--------------------------|-----------|
| Editors Memo | 8 | From The Ground Up | 40 |
| Sunday Flier | 14 | Top Out | 41 |
| International Circuit | 39 | Roostertail | 45 |
| Showcase '64 | 55 | | |

FREE FULL SIZE PLAN FOR THE DQA-704



COVER: Sally Dewey with DQA-704, talks with Don Mathes, designer of Digester, shown in foreground. Radio gear is the Babcock BC-22 and Kraft quad proportional systems. Ektachrome by Gil Duarte.

- Editor* **DON DEWEY**
- Managing Editor* **CHUCK WAAS**
- Contributing Editors*
 - KEN WILLARD**
 - TED STRADER**
 - FRANK JUSTIN**
 - DON MATHES**
 - JERRY KLEINBURG**
 - GARY PREUSSE**
- Foreign Editor* **CLIFF RAUSIN**
- Contributing Editor*
HENRY J. NICHOLLS
- Photography*
 - GIL DUARTE**
 - DICK TICHENOR**
- Consumer Research*
BILL O'BRIEN
- Plan Service*
GORDON MADISON
- I.M.P.B.A.*
MERT MISCHNICK
- A.M.A.*
GEORGE WELLS
- Administration*
PAT McCLOSKEY
- Editorial Assistant*
JOYCE STOLPE
- Reader Service*
SHIRLEY BYERS
- Correspondents*
 - GEOFF FRANKLIN**
 - BILL MURRAY**
 - DAVE SKINNER**
 - MONTE MALHERBE**
 - JACK ALBRECHT**
 - JOHNNIE CARROLL**
 - PER-AXEL ELIASSON**



EDITORS MEMO

By DON DEWEY

THIS IS RCM'S 'AGE OF PROPORTIONAL' ISSUE — we have tried to present a perspective of proportional control from a simple, rudder-only pulse proportional airplane all the way to a discussion of how to utilize the extra channels on an eight-channel proportional system. As part of our research for this issue, we have had the pleasure of flying Don Mathes' "Digester" complete with the new Kraft Proportional System. This airplane has a fantastic record of well over two thousand flights without mishap. In addition, quite a few RC'ers have logged their first dual and solo proportional time on this big ship. We found it to be the finest proportional trainer available today. Large and forgiving, yet capable of the entire A.M.A. pattern even though it does not utilize ailerons!

The age of proportional is here. From rudder only on up through "full house" — we hope you will like this issue. We hope, too, you'll like our bit of "interior decorating" and the added number of pages. Beginning soon, you'll find a monthly section devoted to the beginner—the brand new modeler and pilot who has a myriad questions. We'll try to answer some of them with a picture and text section covering a different phase of R/C each month, all the way from building through flying. The old pro can skip this bit — there will be even more for him than before. We try to present something for everyone — when we fall short, just let us know and we'll do our best to balance the ledger.

Did you ever wonder what the guarantee slip accompanying a new piece of radio equipment really means?

During the past couple of weeks, we have had the opportunity of finding out. A few months ago, we ran a review of the Babcock Digitran, a single channel system that provides right, left, up, and down, plus quick

blip motor control, with the rudder and elevator functions being controlled by a transmitter stick operating a timing device — in effect, an educated thumb that eliminates button pushing in order to obtain the desired command sequence.

As received from the manufacturer, this superhet unit performed completely reliably. Insofar as the beginner was concerned, it's only drawbacks were that it was very critical as to peak tuning, and careful installation was required to avoid feedback noise to the superhet receiver.

Following our report on this system, however, we received letters from readers who could not, for various reasons, make the Digitran system work as ours had done, or as specified by the manufacturer. As is our policy concerning complaints about any manufacturer's products, these letters were forwarded to Babcock Controls.

It was during this period of time that Stuart Babcock was in the process of purchasing the assets of Babcock Models, a company that he had sold several years prior in order to devote his full engineering time to fulfilling his government contracts for proportional radio equipment. Although he was in no way responsible for the products engineered by the company bearing his name prior to this recent purchase, Stuart Babcock inherited the controversial Babcock BC-18 — along with our letters of complaint.

The first releases under the newly purchased, and reorganized Babcock Controls, was the BC-21 and BC-22 systems — single channel radio equipment designed for the beginner and sport flier, and incorporating some very outstanding design considerations. From the correspondence we have received on the BC-21 system, it appears that this first release has met with a very enthusiastic reception on the part of the RC modeler.

(Continued on page 38)



The Age Of Proportional

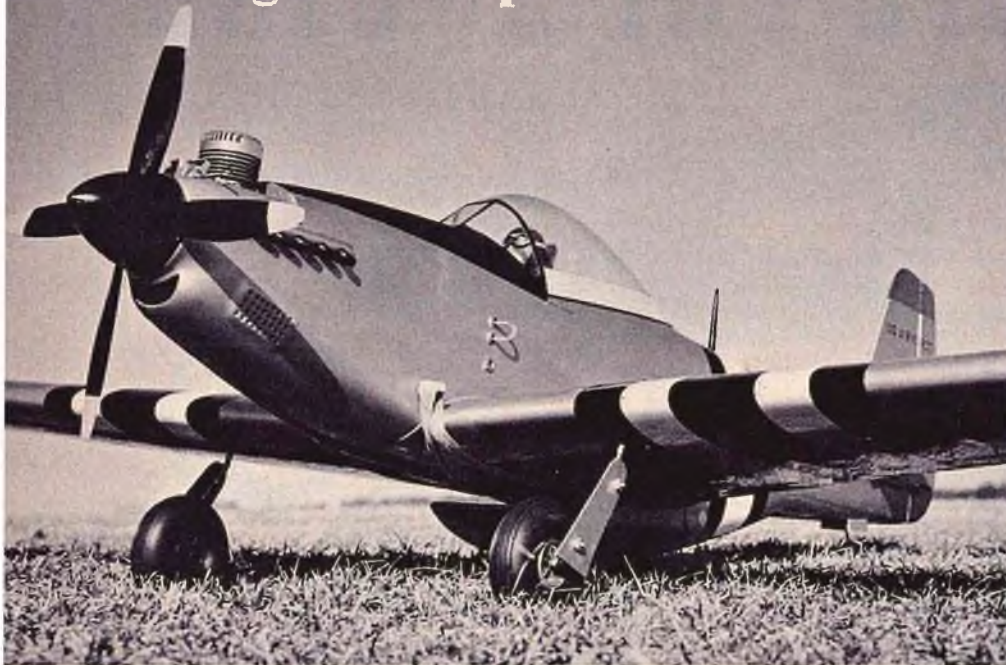

Is It Here Or Isn't It?

by Al Doig

Interest in proportional radio control has rapidly increased during the past year. The reason for this interest is the current ability (if you have the money) to buy some equipment, to read about other systems, and to listen to flying field scuttlebutt about many more. The gestation period has been lengthy. Equipment has been appearing bravely on the field and retreating painfully to the laboratory. This is a perfectly normal procedure, but this time it has been carried out under the glare of spotlights!

When you finally lay out your hard-earned and considerably large bundle of scratch and take delivery on your shiny new Zilch Simultaneous Proportional — just what are you getting? How can Joe Modeler evaluate one system against another?

There are, in general, two kinds of control systems — digital and analog. In a strictly digital system the control information is carried as a number.

That is, if a representation of the number 3 were transmitted, it might mean that an inclination of 3 degrees was desired, or that a **change** in setting of 3 units was wanted, depending upon the individual system. An analog design carries the information in a form that is generally measurable. That is, the measure of voltage represents the precise setting desired — or the frequency of a tone might represent the same thing. As the **measurable quantity** changes, the control changes in direct proportion.

The mechanization of these two types of systems is quite different. In general, circuitry for the digital system is capable of being in one of only two states. It is either **on** or **off**. A light switch is typical of digital circuits — it is either on or off. The light **dimmer** is representative of analog proportional control. Here, the angular position of the knob describes what brightness the light should be.

We might ask as a result of this explanation, "Does the analog system automatically mean a more smooth control?" No! Our light switch gives a very coarse control because we designed it with two numbers, 0 and 1 — that is, on and off. If we were to provide the operator with many more numbers to select from, the control could be made as finely defined as desired.

The previous discussion is, however, somewhat academic because there are no known truly digital systems designed for the model hobbyist. The discussion was useful, however, to describe types of circuitry used in each system. All so-called "digital" systems are a combination of digital and analog. They may be classified as digital, however, because the circuitry is predominantly of the digital type.

Analog systems are again of two general types — those that transmit tones whose frequency describes the desired control position (see "Ulti", American Modeler, May 1959) are of one class. Those that transmit pulses whose frequency and symmetry describe control positions form the other (WAG). These two classes have been effectively combined in some analog systems.

Digital systems are nearly always variations on the same theme. Strings of pulses are transmitted. Each pulse controls one function. The first, elevator; the second, rudder, etc. The control variable is the pulse width. Various schemes are used to decode or separate the pulses and transform pulse width information into servo position.

One feature common to both digital and many analog systems is the feedback servo. Early WAG systems were open ended. That is, the servo was told to go to a particular setting but there was no assurance that it really did. In present designs, the servo receives the desired command position. The actual servo position is defined by the position of a potentiometer which is driven by the servo shaft. The desired position is compared with the actual position. If these are not the same, an error signal is created which moves the servo until they are the same.

(Continued on page 12)

Which system is better? Actually, there is nothing inherently "better" about one system or the other. Each has its own features and characteristics. The advantage of analog is its simplicity. This system tends to have less parts and be more straightforward. A big advantage of digital control is its expandability. An eight function receiver is little more complex than a four function unit.

Proponents of analog systems claim greater immunity to interference. This is possibly true, although from a practical standpoint it may be impossible to tell the difference. In analog systems, the devices used to discriminate the tones offer considerable rejection to disturbances. A digital system tends to be wide open unless the pulses are transmitted as bursts of tone. Noise or interference tends to appear as good information and can confuse the digital set. Steps are taken in the design considerations to prevent this, however, and there appears to be no observable difference. An on-frequency signal will clobber either system.

It appears that tighter control, more repeatable neutral, and smaller dead band is more practical with digital than analog. This statement will enrage analog proponents, and rightly so, as I would be hard pressed to prove it analytically. In my opinion, the single most important criteria to look for in a proportional system is deadband. In other words, how far can one slowly move the stick in either direction before the surface will move. A second important point is the speed of response. The sum of these two characteristics account for the stick action you have observed from some very good proportional pilots. Stick action in this case is not the smooth movement one might expect. When a change of control is desired, the stick is moved beyond the final point and returned to the proper position. The stick also is constantly being moved. This overtravel is necessary from either or both of two conditions. First with excessive deadband, and in order to get small changes, it is necessary to exceed the dead zone error in order to get the servo going at all. Therefore, the stick is moved beyond the point desired to start the servo moving and then returned to the proper spot to stop it. This overtravel

control is also used to speed up the servo by applying maximum error voltage with exaggerated control movement. This starts the motor at maximum speed. The stick is then returned to stop the servo at the proper spot. A skilled flyer can fly this type of system wonderfully well. An unskilled flier will encounter difficulty — especially when using a sensitive, high-performance aircraft.

The crux of this whole problem is the nature of the proportional information from the receiver and the nature of the feedback signal from the servo. The tendency is to transform the information quantity (tone, pulse rate, etc.) into a D.C. voltage and compare this to a D.C. voltage divided down from a battery with a position potentiometer. As the information voltage tends to be in pulsating form, it is necessary to smooth it out. This is generally done with resistance-capacitance filters. It is desirable to smooth this voltage as much as possible. Filtering, however, slows the ability of the voltage to change level, thereby slowing down the response. Lack of filter will cause a ripple on the information voltage. When this is compared against the positional D.C. voltage, an error signal would be generated whenever the voltages were different — that is, at each ripple peak. This will cause the servo motor to continually "buzz" and draw current. The alternative is to build-in a dead zone to ignore the ripple and act only on larger changes. This tends to result in a control dead zone. The digital system would suffer the same disadvantage if it were mechanized in the same way. The saving grace here is the ability to generate feedback signals from the servo that have the same form as the information pulses. It is, therefore, useful not to transform into D.C. at all. The comparison in this case leads to an error pulse that is filtered and used to move the servo. This presents an entirely different picture. Hence, response can be very rapid and the error signal easily amplified to achieve excellent definition and minimum dead zone. The same principles could be applied to an analog system but not quite so easily.

We all live by comparison, and one popular comparison for proportional radio seems to be "is it smooth or

jerky?" This is a valid comparison if one carefully observes what "jerky" really means. This goes back to our definition of dead-band. If, as the stick is moved, the servo follows by galloping, this means that the deadband is wide only if the increments of gallop are large. The thing to be careful of here is the ability of the servo to define the stick position. A jerk of a tenth degree is much to be preferred to a smooth gulp of several degrees. This is hard for many modelers to grasp. It is particularly important to have the servo loaded during these observations. If you have a chance to try this in a ship, pick a control with drag such as rudder with steerable nosewheel, or aileron with a sticky linkage.

Some people take to proportional flying like a fish to water — some don't. Most difficulties arise from habit and habitual reaction. For the flier converting from reeds, there will be a training period. The unfamiliar location of controls, coupled with the hard-learned automatic reaction to panic situations, create problems that have nothing to do with proportional control. Arguments will go on and on as to the relative merits of two stick versus one stick control. This really relates, not to the number of sticks, but the separation of aileron and elevator. At least one manufacturer offers this separation as an option. It is a real fact that almost no flier is able to simultaneously use two thumbs unless one is held still. When making a turn in a reed ship, aileron and elevator are beeped alternately, not simultaneously. It is this author's opinion that the single stick in one form or another will become the standard. Separate sticks will offer the easiest transition from reeds.

Most proportional sets install just like reeds. The notable exception is relative immunity from vibration. Some manufacturers are recommending no metal-to-metal joints anywhere if there is a possibility of rubbing contact such as pushrod connections, etc. It has been stated by these manufacturers that the noise generated at such points will cause malfunction under certain conditions of extreme range, etc.

The overall weight of proportional

(Continued on page 46)

SUNDAY FLYER



"Hey, what happened to your column?"

"You mean you missed it?"

"Yeah. I thought you were going to come out with a design or something."

"Well, I was but I got outranked by the Nats coverage."

"Oh. OK. But how about last month?"

"The design had a couple of bugs in it, and I wanted to get rid of them for sure before I published it."

"And you did?"

"Yes, but what with vacation — and my wife doesn't like me to work on models then — and getting back into a working mood, I didn't finish the plans. So I'll finish them up and you'll see them next month. Right now I'm reviewing some of the pitfalls — and progress — of the small single channel receivers. Things I've learned to watch out for."

"Sounds good."

That isn't the exact conversation,

but it's pretty typical of several that I've had. So, after checking with our editorial watchdog, I've compiled a few do's and don'ts for you Sunday fliers who've had some troubles with your small transistorized receivers.

First, though, it's interesting to briefly look back and see how we got where we are, and to what end competition among the manufacturers has been responsible.

From the letters I've received, a lot of you sport R/C'ers are old time free fliers who like to keep abreast of R/C developments, but for your own flying your fun comes from stooging around in the sky, and then being able to get your airplane back without running your aging legs off. Many of you have been brought back into the hobby through your sons' interest — and that's great. There should be more of it!

But maybe you remember ten or fifteen years back, when you were out with a free flight, and over in one

corner of the flying field the boys like Howard Bonner, Walt Good, Jack Port, Frank Hoover, Jim Walker, Vern McNabb, Pappy deBolt and other pioneers were struggling to get their radio controlled models airborne. The models were fine — but the radios left a lot to be desired. Nobody was more aware of that than the pioneers themselves — and they did something about it!

The old gas tube receivers gave way to the "two tubers" — like the Deltron, with an RK-61 and IAG-4 operating on a "carrier on, carrier off" basis. For you fellows who've never known anything but a "tone" receiver, such as is universal today, maybe a word of explanation is in order. The "carrier" receivers were basically not in communication with the transmitter unless the transmitter was not only turned on, but the button was pushed, which closed a circuit so that

(Continued on page 48)

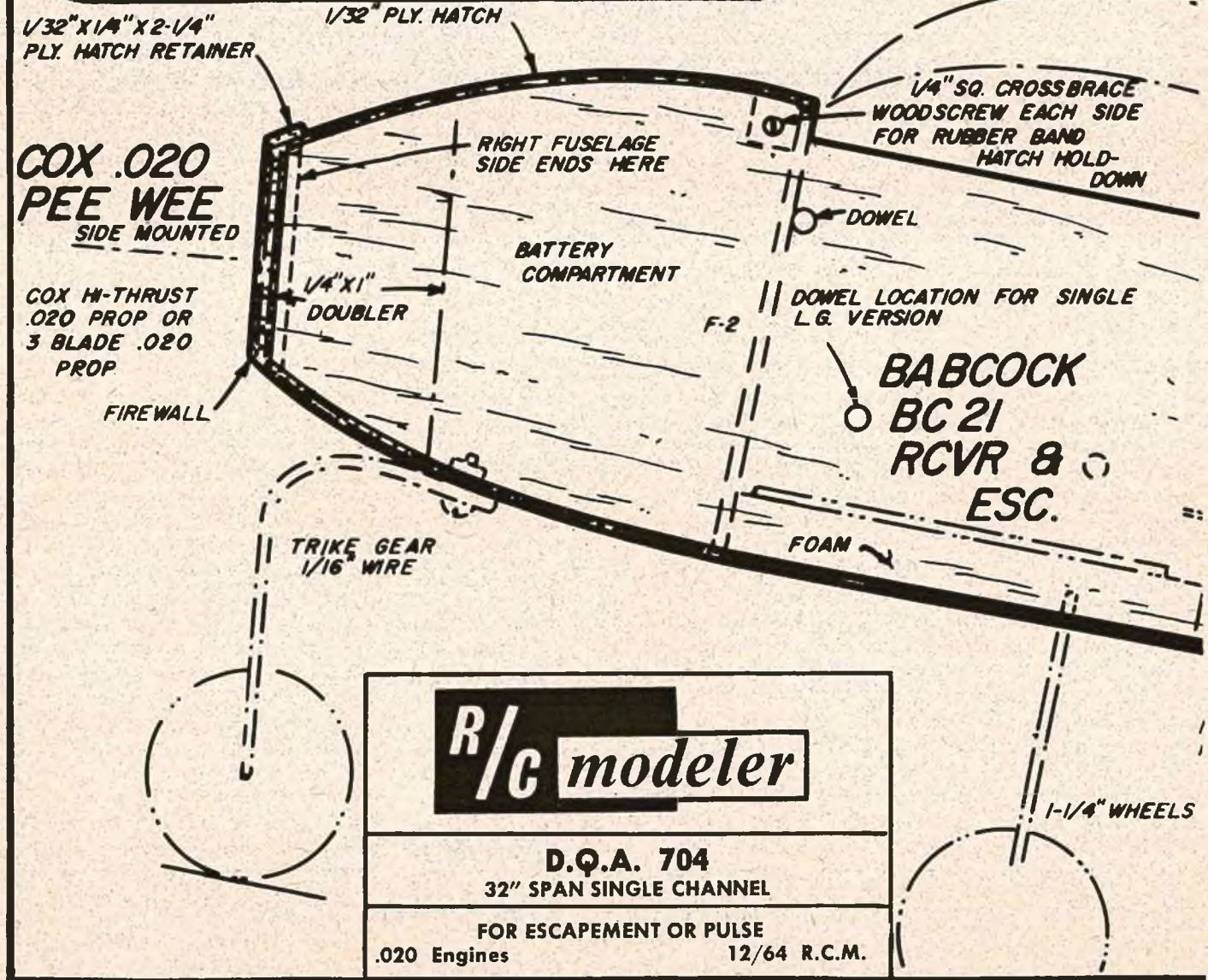
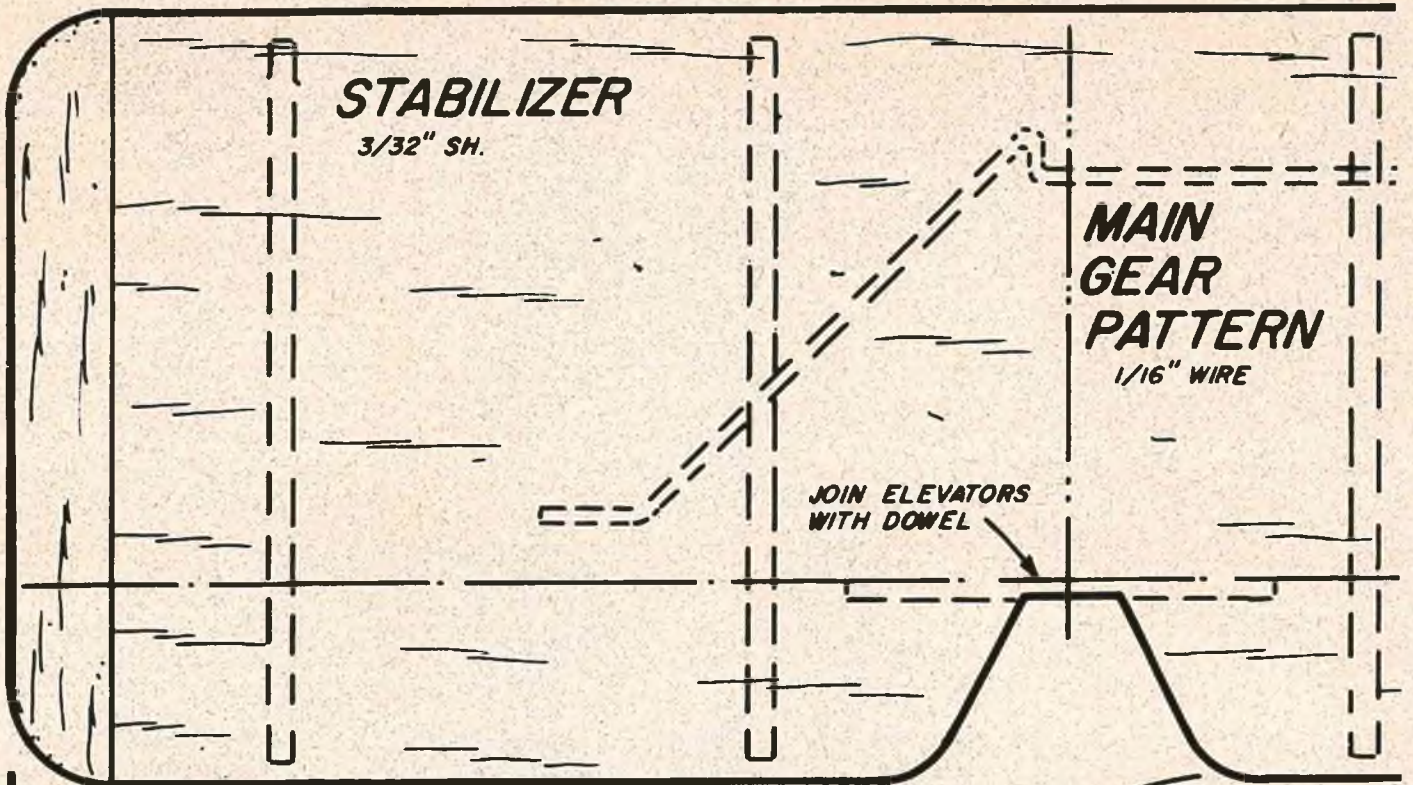

| | |
|----------------------------------------------|-----------------------------------------|
| R/c modeler | |
| D.Q.A. 704 32" SPAN SINGLE CHANNEL | |
| .020 Engines | FOR ESCAPEMENT OR PULSE 12/64 R.C.M. |

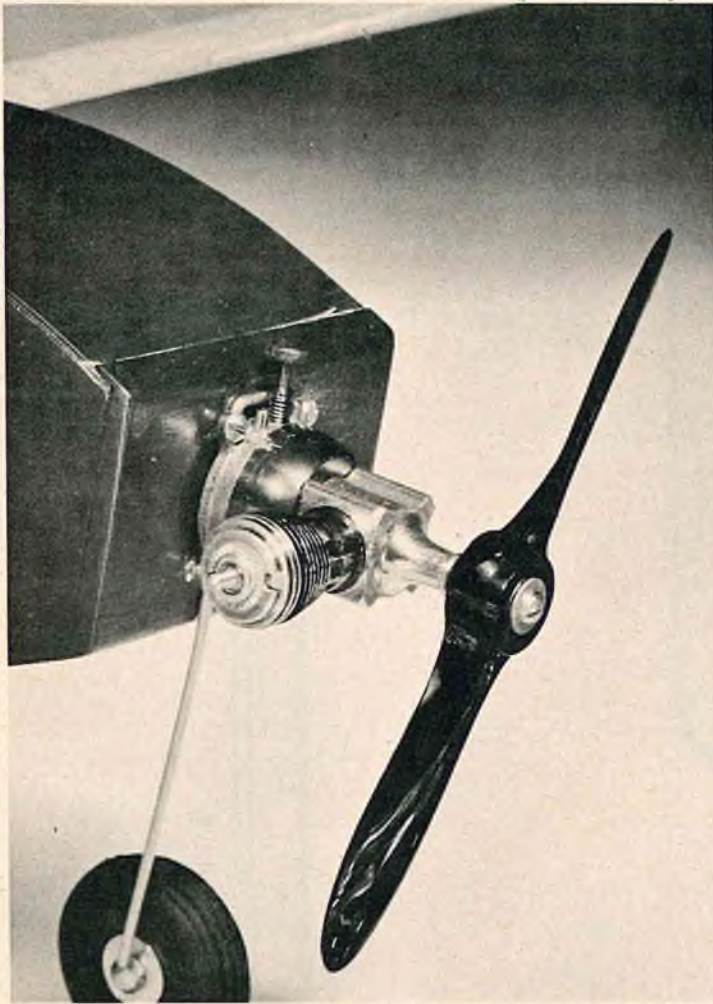

DQA 704

Design: S.K. Babcock
Text: Don Dewey
Flight Tests: Bill O'Brien

Full-size plans for a remarkable 32" span rudder-only proportional design. Extensively flight tested by RCM, the DQA 704 is the first step in the Age Of Proportional.

The D.Q.A. 704 was designed in the Summer of 1964 by Stu Babcock as a testbed for Babcock Controls' new BC-21 and BC-22 single channel systems. When RCM's Consumer Research Department received the first production unit of each system for evaluation, they were installed in two of these 32" span models — a welcome breather for our tired old fleet of test ships! After several days of F.T.E. (Flight Test Evaluation — space age terminology for an excuse to go flying instead of editing copy!), we were not only thoroughly convinced that Babcock's new single channel escapement and proportional systems were ideally suited for the sport flier and newcomer to radio control, but that the ship used as a testbed was one of the best flying, small-field sin-

gle channel airplanes we had run across!

The combination of the DQA and either one of these tried and proven control systems assures success for the beginner and gives him the feel of radio control flight at very low cost. It puts him in an excellent position to get his own opinions on larger more powerful airplanes and control systems that he will want in the future. The DQA is simplicity itself to build. The control systems are the easiest to install of any we have evaluated.

Performance-wise, the trike-gear mite tracked straight across the asphalt, lifted off easily, and bored straight into a gusty wind at a slight angle of climb. We got the impression that the 704 would probably bore

straight ahead until it ran out of fuel unless we turned it — so, we started playing with the knob on the BCT-22 transmitter. A slight twist of the knob and the D.Q.A. responded with a beautiful banking turn, unlike the more "jerky" turns usually associated with escapement flying. Progressing downwind, now, the ship retained its altitude without any tendency to climb. Another right, and we turned about into the wind. Centering the knob on the transmitter we tracked, for a moment, straight on heading, then depressed and held the "full left" button. The D.Q.A. responded immediately by entering a left spiral. After a few spiral turns to gain speed, we released the button and the D.Q.A. went up and over into a loop, recovered easily, and once again bored on

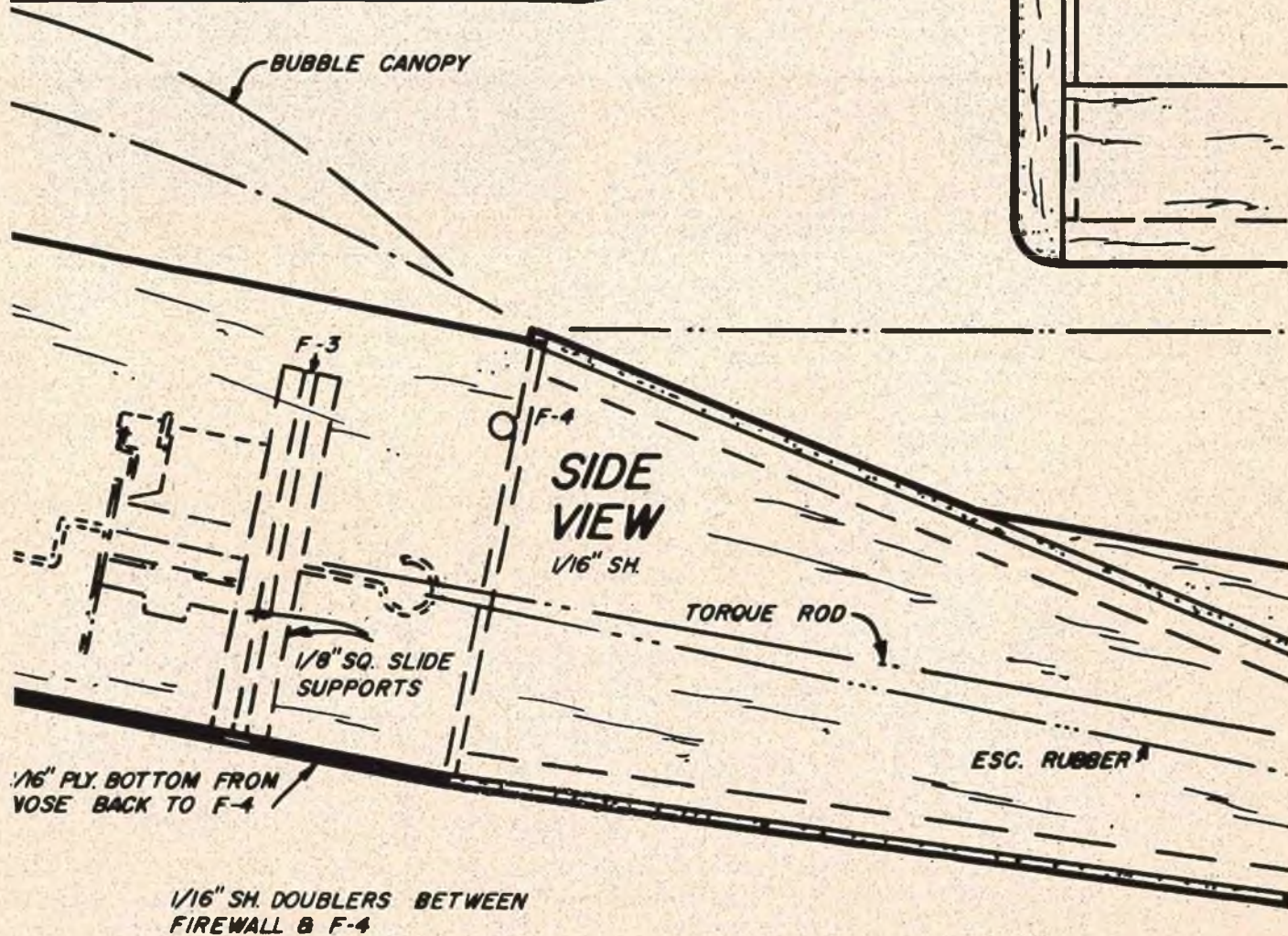
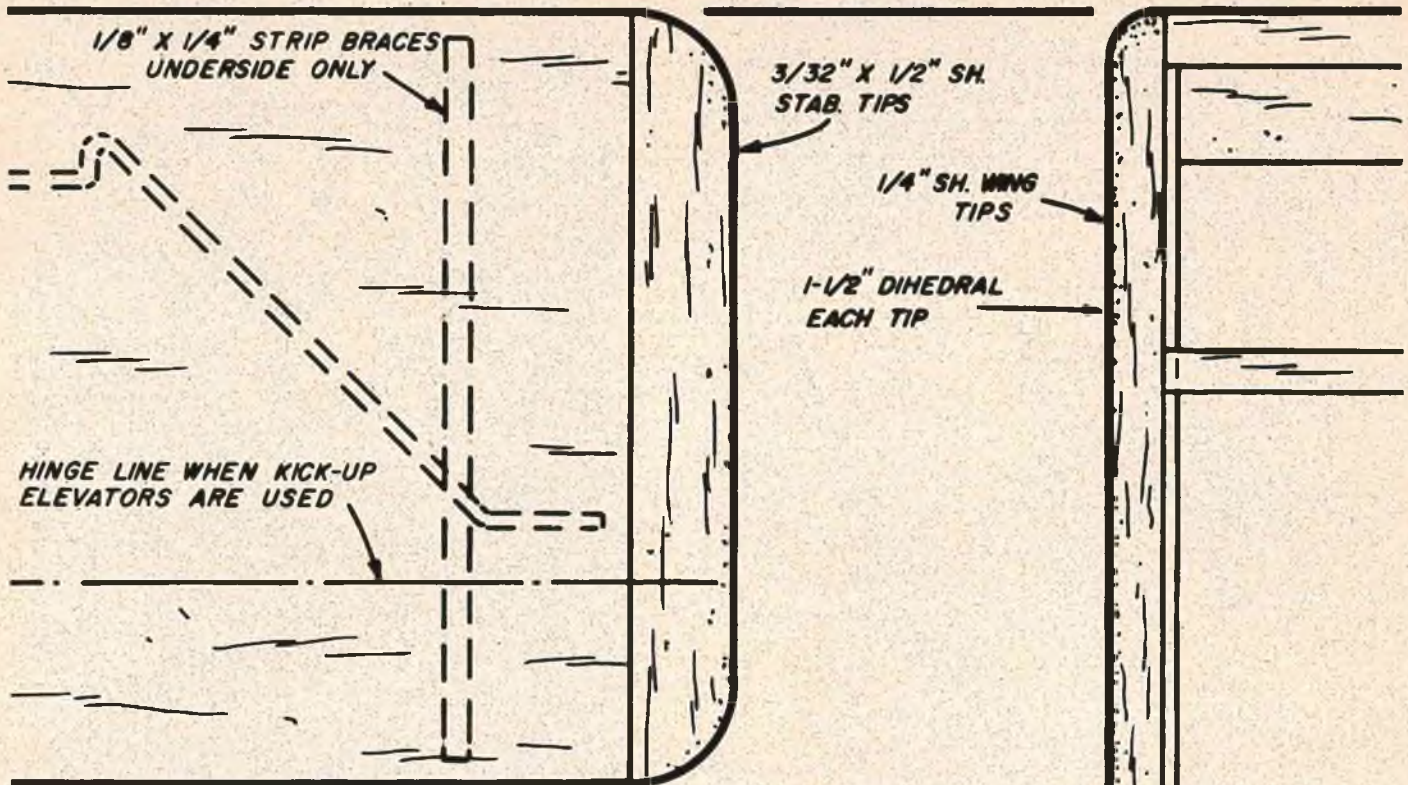

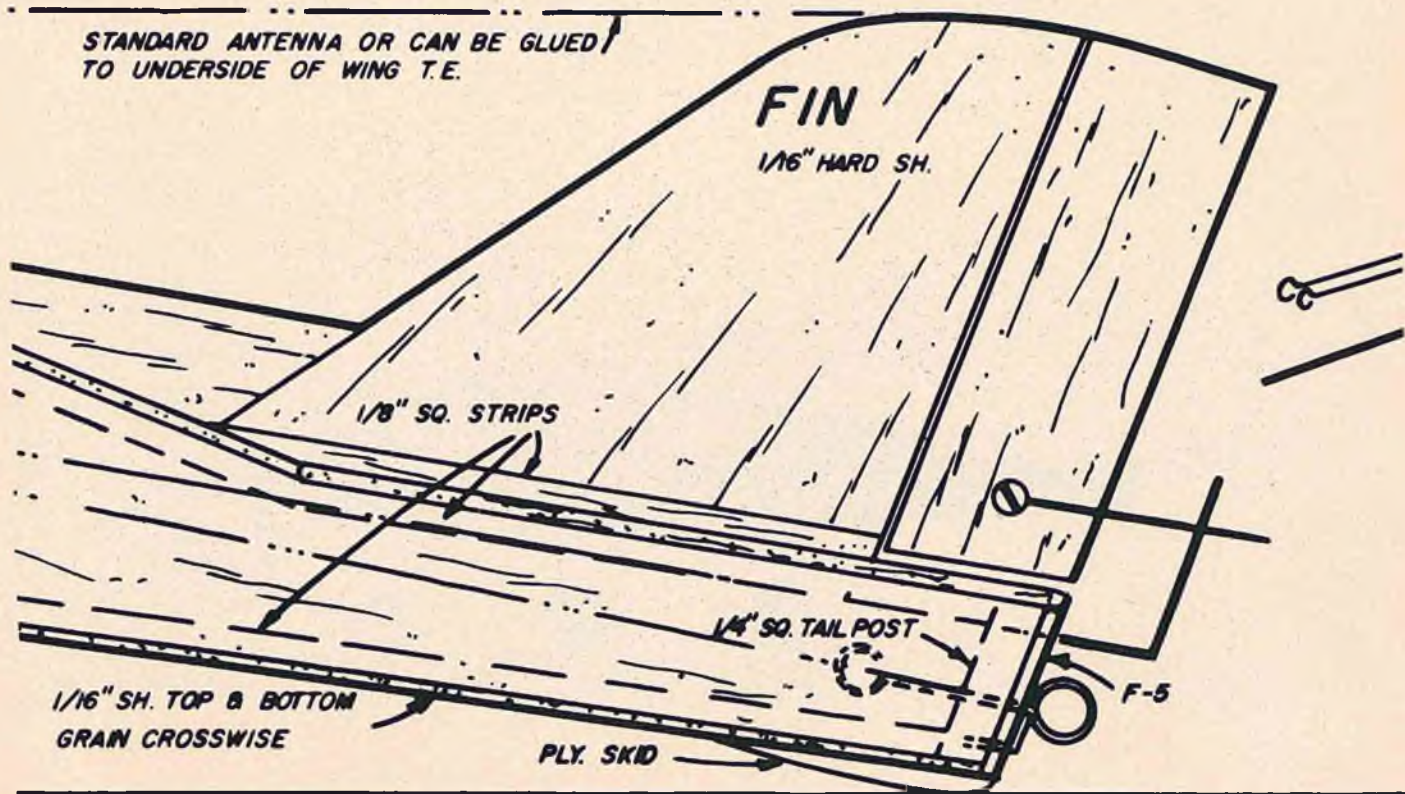
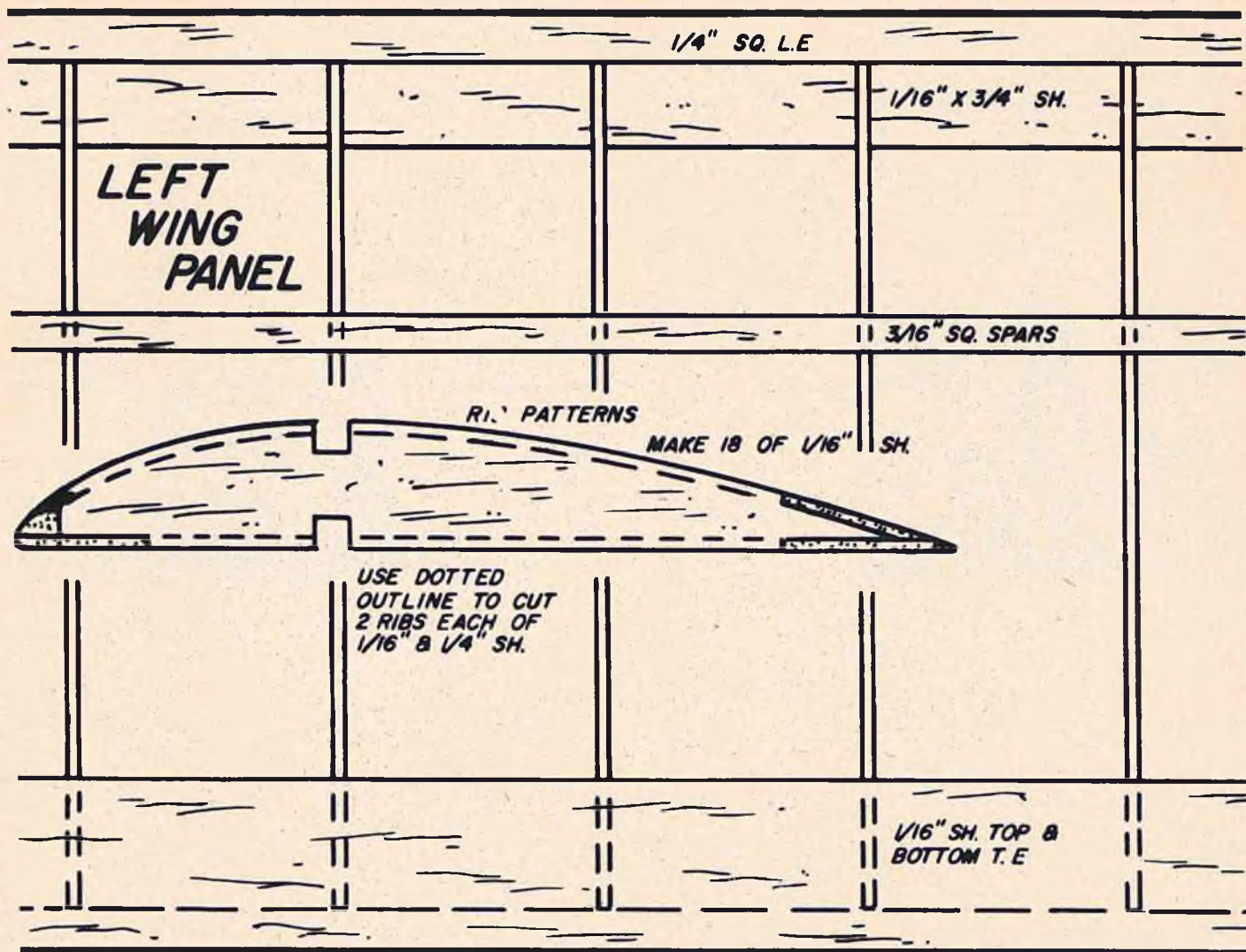



Don Mathes launches the DQA as Sally Dewey operates the BCT-22 transmitter.

into the wind with a slight climb. After a few more laps around the field, plus another couple of loops, the Pee Wee .020 ran out of juice and we began our descent. For the experienced single channel sport flier, the glide rate of the D.Q.A. would be too shallow and he would probably remove a slight amount of incidence — for the beginner in R/C, it is ideal — a flat, almost-floating type of glide reminiscent of the old free-fighters. Turning onto the final leg, the 704 pointed its nose into the wind, tracked straight and steady, then touched down on all three wheels and rolled about twenty five feet to a stop.

Each flight thereafter was the same — smooth takeoffs, excellent wind penetration, smooth banking turns, easily executed loops, and a well-defined glide pattern followed by a hands-off landing.

When we telephoned Stu Babcock we were full of praise for the D.Q.A. After listening to our ravings for a few moments, he asked simply — “How about the radio gear?”

“They’re fine”, we replied, returning to further exploits of the D.Q.A. “How about working this ship as a first bird for the newcomer to R/C, and as an all-around sport flier in conjunction with your new radio gear?”, we asked.

The head of Babcock Controls persevered through to the very end, maintaining a patient, and somewhat stoic silence, on the other end of the line. Perhaps through desperation, or the fact that we called collect, he then hastily agreed to presenting the plans herewith, mumbling something to the effect of “Some product evaluation...! Are you evaluating the radio or the airplane?”

For the more scientific minded, “D.Q.A.” is a Babcockism which stands for “Damn Quick Airplane.” The “704” was tacked on at RCM when it was determined that the entire bill of materials, including engine, came to exactly seven dollars and four cents! (Glen Sigafoose at Sig Balsa may not get wealthy over this one, but Glen’s loyal supporters can always build the “Digester” in this issue!) In addition to being an excellent flyer with none of the erratic tendencies of many .020 size



The worried look was in vain... she cleared the Digester and assorted paraphenalia!

designs, the D.Q.A. is economical, extremely fast building, (one weekend), and very, very rugged. To test the latter feature, we deliberately brought the little bug straight down into the asphalt under full power with no more damage than popping off the firewall. Stu Babcock bounced his off the top of a culvert fence and down into a twenty-foot deep drainage ditch with only a fractured firewall as a consequence!

We followed our initial tests by building five more prototypes and passing them around to local RC’ers — all flew in exactly the same fashion. So, scrape the glue off the X-Acto,

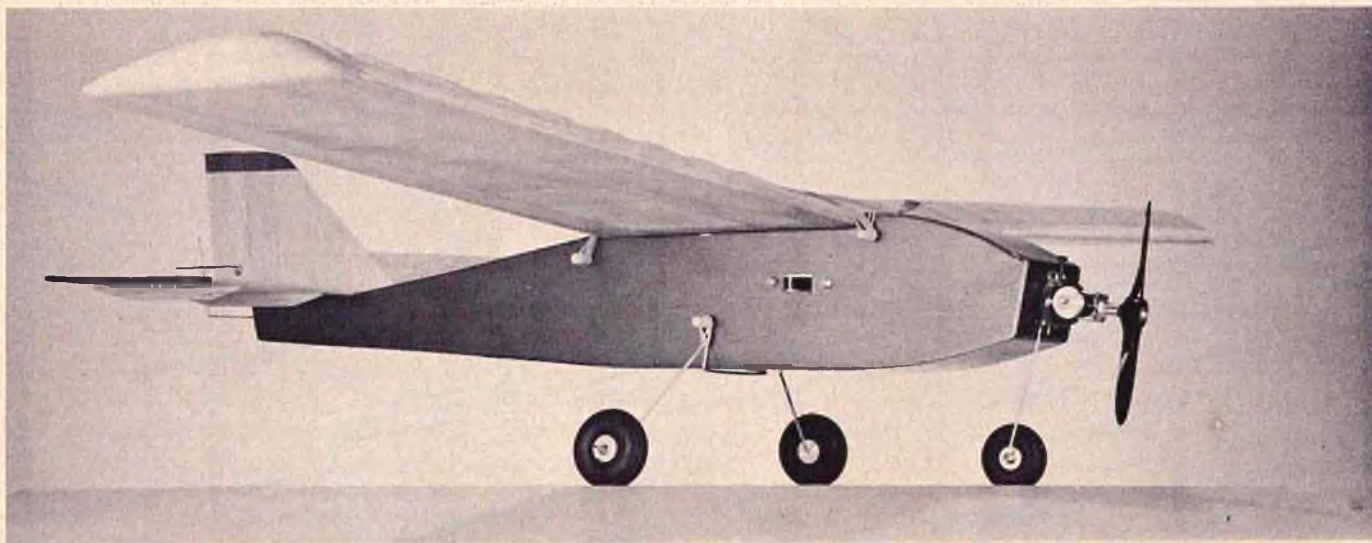

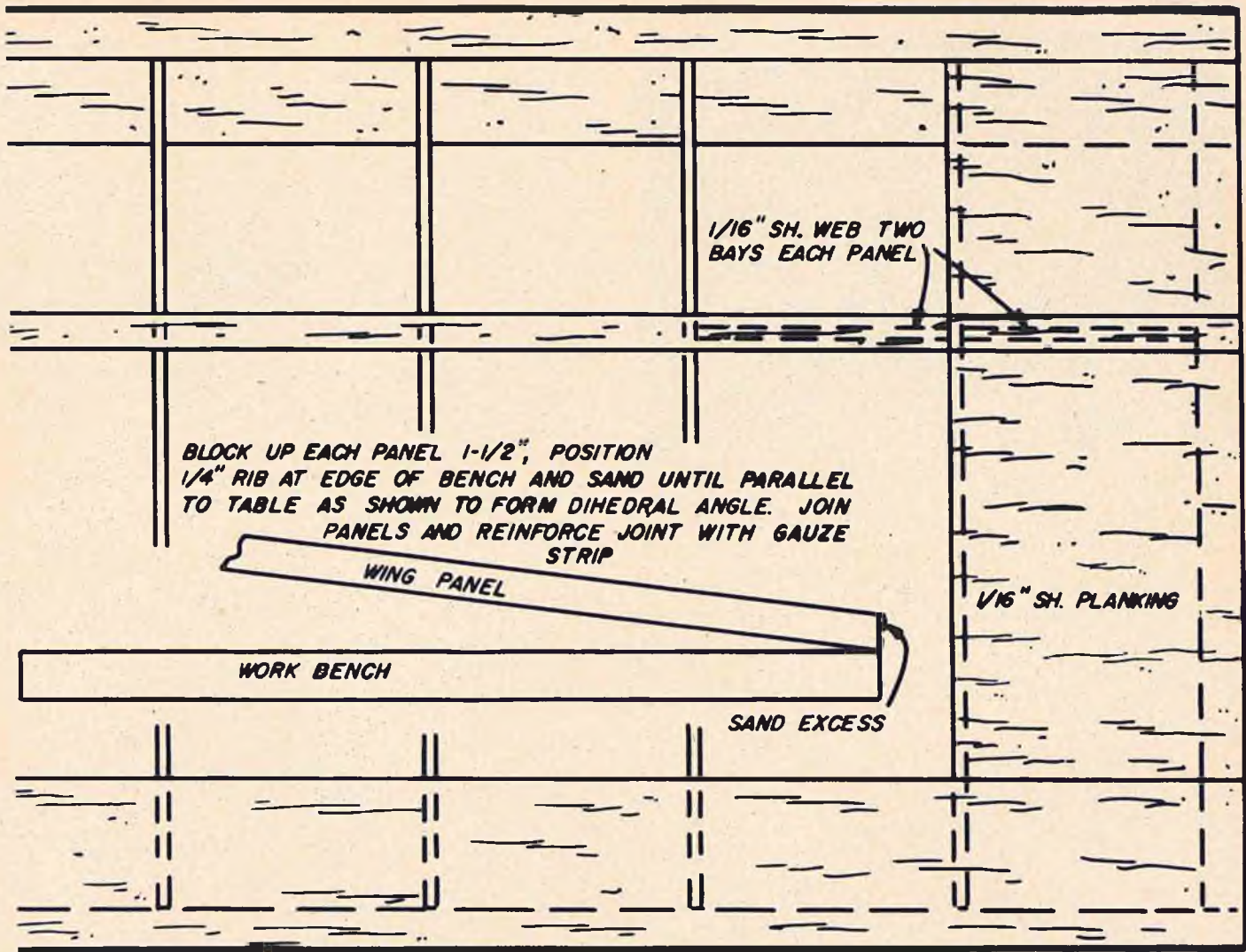

BULKHEAD PATTERNS

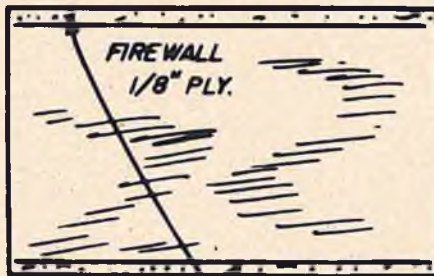

BEVEL EDGES

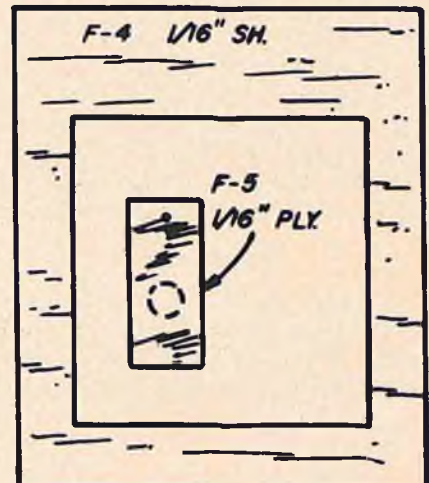
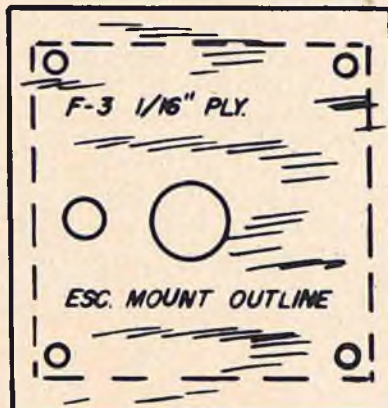

The **DIGESTER**



by Don Mathes

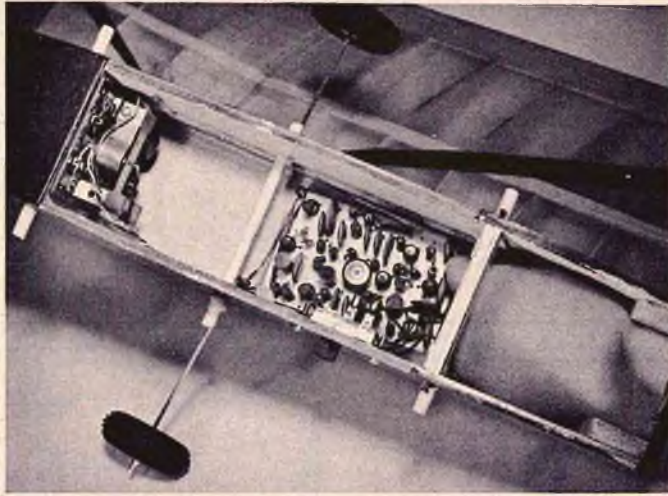

The BCR-22 receiver and PA-9 actuator installed in the DQA. Sponge rubber in the nose section hides the two 9 volt transistor batteries.



Three evenings to build... and you have a rugged sport flier for escapement or pulse. One of the best we have flown!

and let's get to work. If this is your first RC bird, follow the instructions throughout and you'll get off to a flying start in a great hobby! We'd like to hear about your airtime with the D.Q.A.

Bill of Materials

1— $\frac{1}{4}$ " x 3" x 36" soft balsa
 2— $\frac{1}{16}$ " x 3" x 36" hard balsa
 3— $\frac{1}{16}$ " x 3" x 36" medium balsa
 1— $\frac{3}{32}$ " x 4" x 36" medium balsa
 2— $\frac{1}{16}$ " x 1" x 36" medium balsa
 1— $\frac{1}{16}$ " x $\frac{3}{4}$ " x 36" medium balsa
 1— $\frac{1}{4}$ " x $\frac{3}{16}$ " x 36" hard balsa
 2— $\frac{3}{16}$ " x $\frac{3}{16}$ " x 36" hard balsa
 1— $\frac{1}{8}$ " x $\frac{1}{4}$ " x 36" hard balsa
 1— $\frac{1}{8}$ " x $\frac{1}{8}$ " x 36" hard balsa
 1— $\frac{1}{4}$ " x 1" x 36" hard balsa
 1—sheet $\frac{1}{16}$ " plywood
 1—sheet $\frac{1}{32}$ " plywood
 1—scrap $\frac{1}{8}$ " plywood
 1—length $\frac{1}{16}$ " music wire
 2— $1\frac{1}{4}$ " Veco or Perfect wheels
 1—1" Veco or Perfect wheel
 1—4" or 5" canopy
 1—yard colored silk
 1—length $\frac{1}{8}$ " birch dowel
 1—Cox Pee Wee .020 engine
 1—Cox Hi-Thrust .020 prop
 Cox Blue Can fuel, glue, clear butyrate dope, thinner, 8—2-56 x $\frac{1}{2}$ " nuts and bolts (Perfect); 4—DuBro or Perfect 2-56 blind mounting nuts; Babcock BC-21 or BC-22 radio system.

Construction

Wing: Commence construction by making a cardboard template of wing ribs W-1, W-2, and W-3. Carefully cut 18 W-1's from $\frac{1}{16}$ " sheet, 2—

W-2's from $\frac{1}{16}$ " sheet, and 2 W-3's from $\frac{1}{4}$ " stock. You can also cut two slightly oversized W-1's from $\frac{1}{4}$ " sheet to serve as wing tips. Now gather ribs together, with the exception of the tips, (all W-1's, all W-2's, etc.) and sand uniformly to match your template.

Lay a piece of waxed paper over the wing plan and tape both plan and waxed paper to your building board. Pin down $\frac{1}{16}$ " x $\frac{3}{4}$ " lower leading edge and $\frac{1}{16}$ " x 1" lower trailing edge. Pin $\frac{3}{16}$ " square spar in place over plan. Glue $\frac{1}{4}$ " x $\frac{3}{16}$ " leading edge to lower leading edge sheet previously pinned in place. Cut and fit lower $\frac{1}{16}$ " center section sheeting, the two pieces fitting flat on the board between the leading edge and lower spar, and between the lower spar and lower trailing edge sheet strip. Now glue each rib in position, making sure each is directly over the plan and at right angles to the building board. Glue the top spar and top trailing edge sheeting in place. Add the $\frac{1}{4}$ " sheet tip. Add $\frac{1}{16}$ " sheet webbing between spars in two center wing bays of each panel, making sure the grain is vertical. Cut and fit top center section sheeting, pinning in place until dry. Follow the same steps for building the opposite wing panel, making sure you have one left and one right.

When the wing panels have dried thoroughly, remove from the board. Cut two pieces of balsa $1\frac{1}{2}$ " high by 5" long and pin one under each wing tip to obtain $1\frac{1}{2}$ " dihedral angle

under each tip. With this blocking installed, line up the $\frac{1}{4}$ " center rib with the edge of your building board, then with a sanding block held firmly against the edge of the building board, sand the appropriate angle into the center rib. Repeat with opposite wing panel. When these two panels join together accurately, re-glue each by rubbing a thin coating of glue over each and allowing to dry. Then, glue each rib again, butt joint, and allow to dry overnight.

When completed, remove dihedral blocking and lightly sand entire wing. Glue a strip of Top Flite pinking tape, gauze, or a 1" wide strip of silk around entire center joint. Brush on two coats of clear butyrate over entire framework. When dry, sand lightly with 400 wet-or-dry paper, then cover wing with four pieces of colored silk, grain running spanwise. If you have never covered a wing before, cut an oversized panel of silk for each wing half, top and bottom, four pieces in all. Loosely fold silk into approximately a 6" square and immerse in a pan of water. Unfold the silk and lay over a turkish bath towel to absorb the excess moisture. Take your dope brush and brush on a strip of clear butyrate about 1" wide across the center section and immediately lay one end of the silk over the doped portion. Press out any wrinkles with your finger. Allow to partially dry, then brush clear dope on the leading and trailing edges about two bays at a

(Continued on page 50)



Don Mathes straps on the wing as RCM's Editor looks on. Over 2,000 flights on the Digester prototype when these photos were taken.



Fueling up. The Digester is one of the easiest handling ships that we have flown, yet will perform even the aileron maneuvers with ease.

(Editor's Note: The Digester is, in many ways, one of the most remarkable models we have even had the pleasure of building and flying. The finest proportional trainer available today, it will also perform the entire A.M.A. pattern with ease. Although the construction is completely straightforward, we will caution the unsuspecting beginner against taking the following article too seriously — we suggest, in fact, that the less experienced RC'er consult one of the "old pro's" in his local group before tackling this project. Read on, and you'll find out why!)

The Digester has many desirable features. Among them are such attributes as ease of construction and flying, ruggedness, plus an inherent stability with no loss of maneuverability. In fact, despite its large economy size and light wing loading, the Digester would make an excellent Class II competition machine. Its most outstanding trait, however, is that it will not rip, rattle, warp, tear, or smell bad in warm weather. Patent pending.

This particular design came about as an effort to help my good friend Glen Sigafoose of Sig Balsa during a slack season. That, and the fact that as former manufacturers developing radio equipment, we needed a test vehicle for our proportional equipment. Thus, the name Digester — Digicon tester. The fact that there is ample room in the equipment compartments for any radio gear available today can best be illustrated by the fact that we flew this ship utilizing **two** complete radio systems — the various proportional rigs undergoing flight tests, plus a permanent reed rig with its servos cross coupled by trim bars to the proportional servos.

To date, the original Digester prototype is still flying and has logged well over two thousand flights without any form of mishap. In addition, quite a few RC'ers have racked up their first proportional stick time on this ship, learning to fly consistently and well with an ease that would be impossible on many of the proportional designs currently available.

This is not to imply that the Digester is a goat — the Veco .45 powering the prototype hauls the eight and a half pound ship through the air at a speed of approximately sixty-five miles per! In the hands of a good pilot it will do the entire pattern including aileron maneuvers. In the hands of the beginner, it is responsive, yet forgiving. Power requirement is from .35 to .60, with a good .45 recommended.

The initial design of the Digester

was accomplished quite scientifically. After carefully considering all of the top designs of the day, we discarded them one by one. Selecting a four foot length of six inch wide sheet from our lumber-mill, we drew the outline of a fuselage on it with ball point pen. Holding this pattern aloft and making noises like an airplane, we decided that the design looked just right. Obviously, therefore, it would fly. Besides, we had a pair of $3\frac{1}{2}$ " wheels around for which we had to find a use.

So, if you're going to build the Digester, go out and obtain the following — (a) one proportional system (b) one twelve-page Sig balsa wood order blank (c) one rip saw and lumberman's axe (d) a lease on an empty 5000 square foot industrial plant zoned for light manufacturing (e) a helluva lot of glue. You might also consider investing in a surplus parachute which you'll need when you get to the covering stage. Outside of that, the construction should offer no particular problems. Since you obviously won't be flying with two separate radio systems, it may be interesting to note that the Northeast Corner Bowery Boys made a complete flight evaluation of the Digester and discovered that two regular size cans of beer can be carried aloft with no difficulty — obviously an added plus for this design...

Construction

No problems should be encountered during the construction of the Digester. The most important factor is to have, at all times, an adequate supply of six-packs on hand. The plans, themselves, are self-explanatory. We know, for we drew them with a pencil and warped piece of trailing edge stock so the draftsman would have no excuse for inaccuracies. All he had to do was trace them. The genius that edits this magazine (Ed's note: True!) built the second prototype of this design from our original plans and ended up with an undercambered wing. Regardless of what he may claim, it wasn't the fault

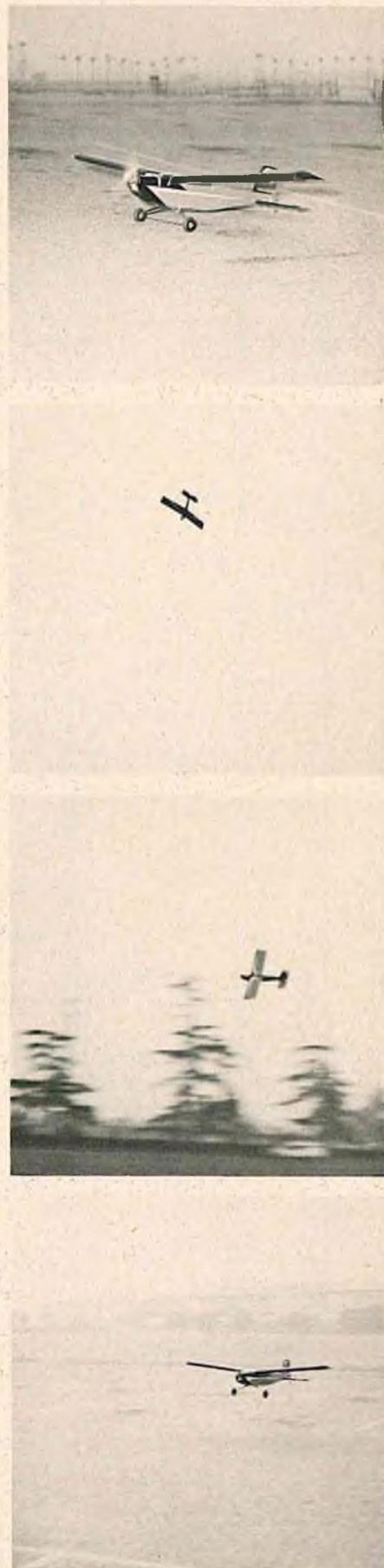

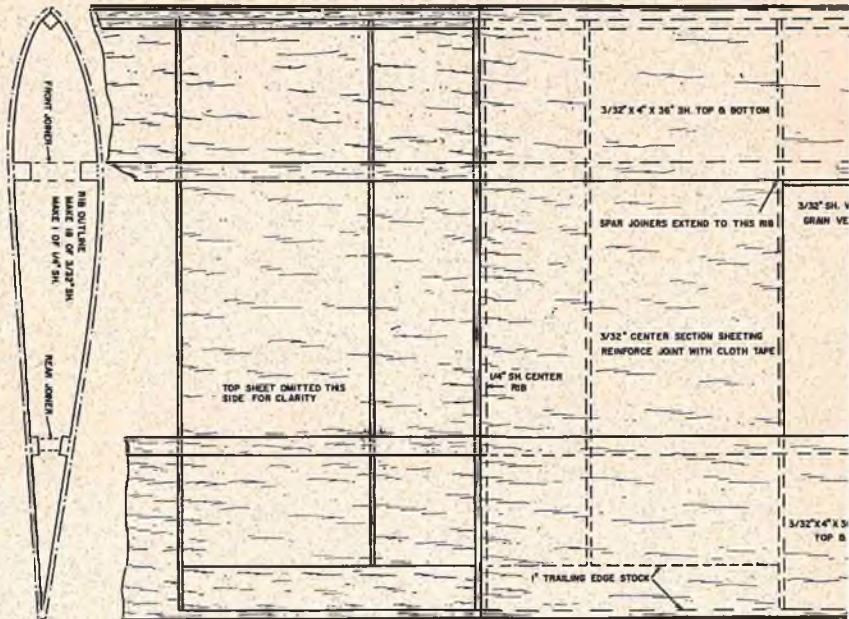
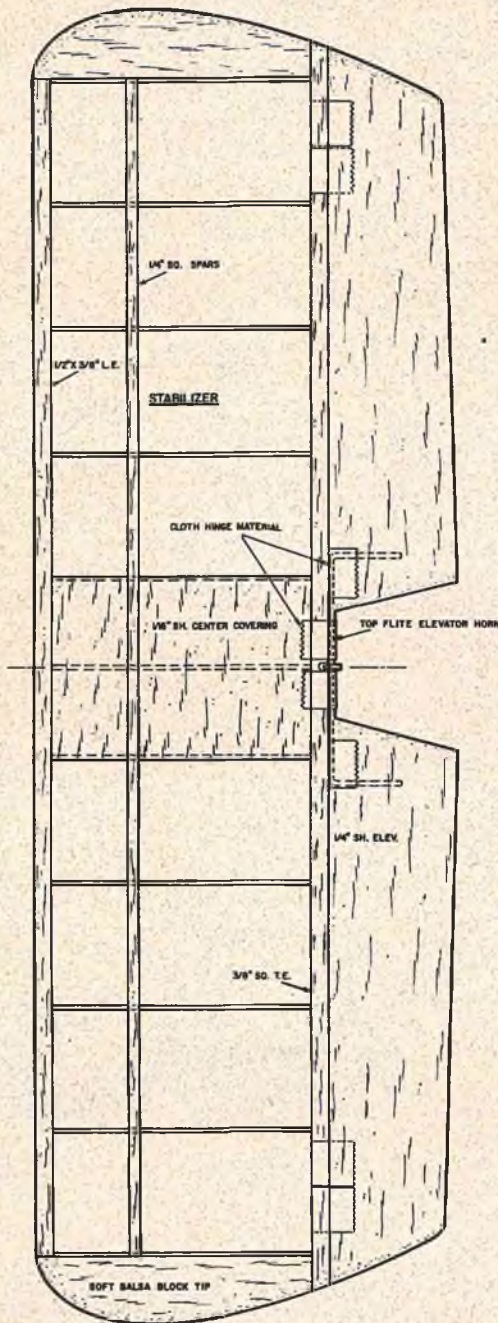

ENGINE MOUNT DETAIL
FORM FROM 1/4" ALUMINUM

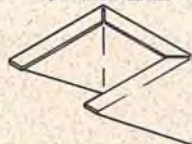

BOLT MOUNT AGAINST FIREWALL WITH TOP EVEN WITH TOP OF FIREWALL. NO DOWNTHrust, 1/4" RIGHT THRUSET EFFECTED WHEN USING VECO .45 & 12/4 PROP

TYPICAL REAR BULKHEAD

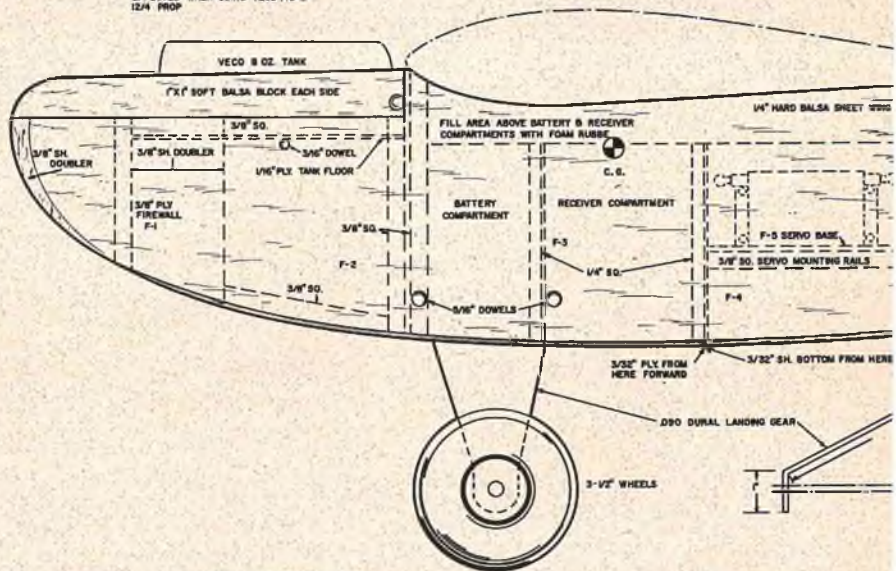

F-1 BLOCKS OMITTED FOR CLARITY



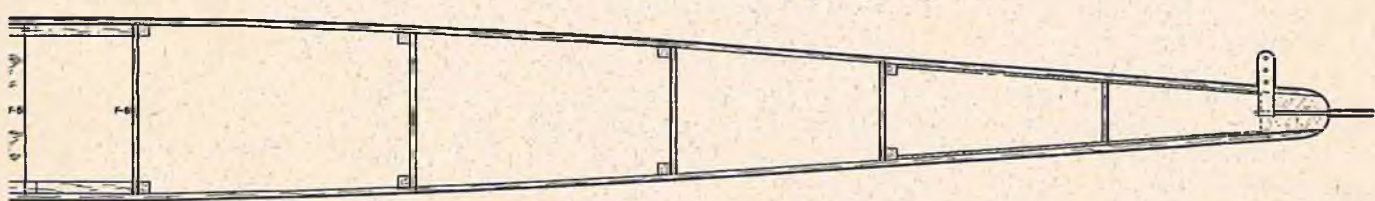
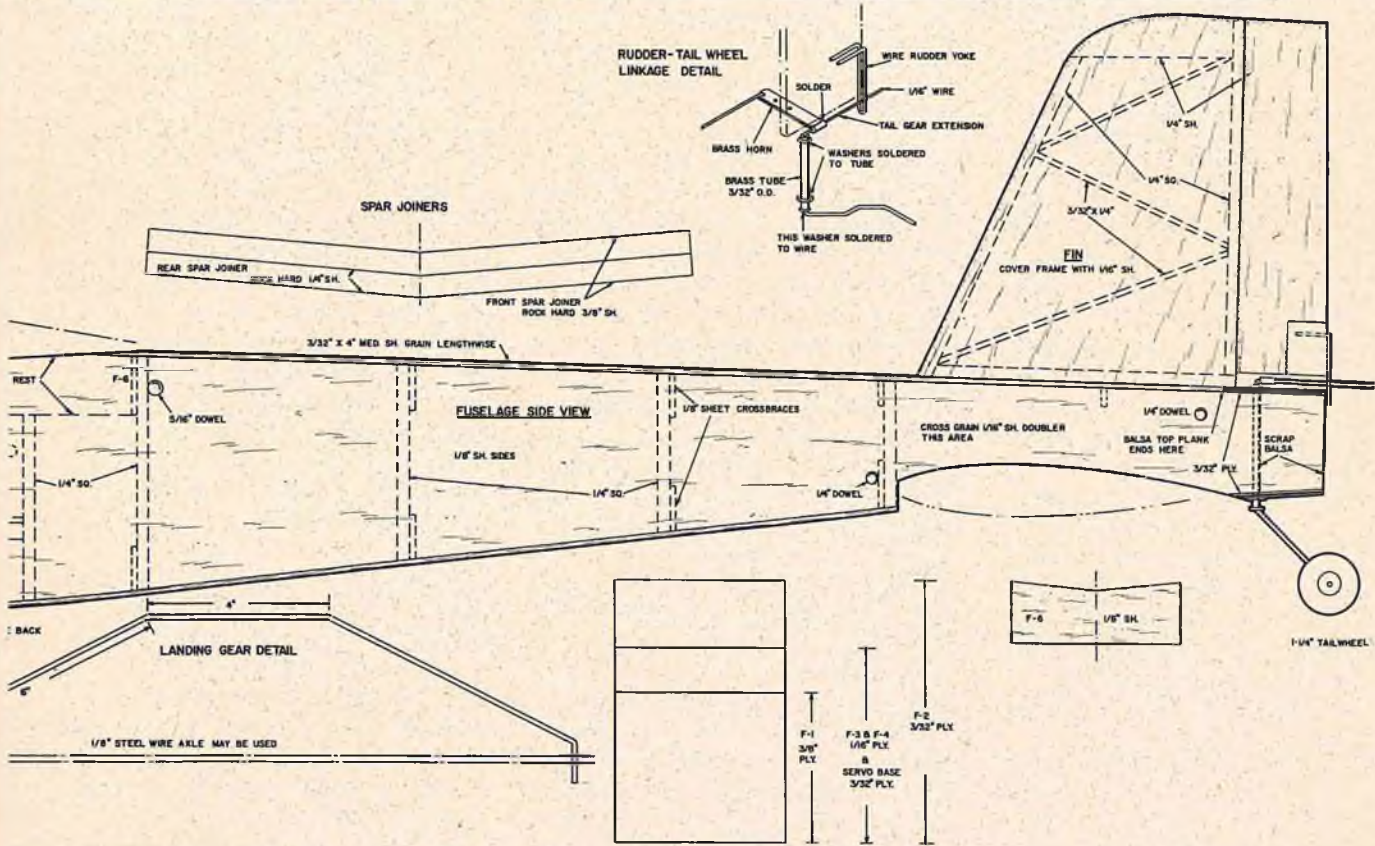
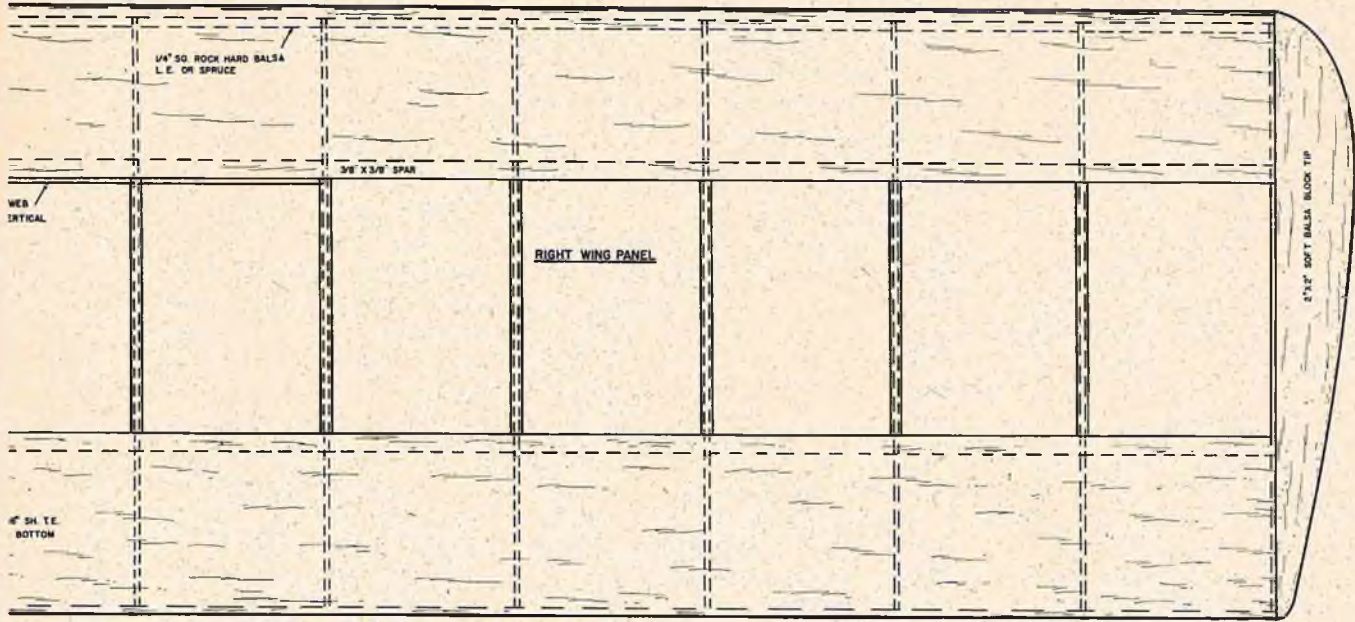

of the plans — it was the linoleum cutter he used for a knife!

Wing: Big deal. Four sheets of 3/32" x 4" x 36" used full size with two 3/8" square and two 3/16" x 3/8" spars in between. Plus an assortment of 3/32" ribs. And a leading edge—1/4" square spruce or hard balsa. Lay the lower leading and trailing edge sheeting down, then the lower center section sheeting, and cap strips. Glue the two lower spars to their respective sheeting. Glue the ribs down. Add the top trailing edge sheeting. Add the spar joiners and webbing where shown. Add the 1/4" center section rib. Moisten the lower leading edge sheeting, add a heavy bead of glue along the entire bottom of the spruce or balsa leading edge, then bend the sheeting up and join. Hold in position with a few hundred clothes pins. When dry, remove clothes pins (if your wife hasn't already done so), and add top sheeting. Cement and secure until dry in the same fashion as above.

Build the other wing panel in the same fashion, joining to spar braces on first panel. Cut a full-grown balsa tree in equal halves and form the wing tips from these two pieces. Sand entire wing. Before doping the structure, and prior to covering, add a strip of Top Flite pinking tape around entire center section. Apply three or four coats of butyrate to the finished wing structure, sanding after second and last coats. After purchasing all of the silk available at hobby shops within a hundred mile radius, you can proceed to cover the wing. A gallon or two of clear dope applied with an exterior stucco paint roller will complete the wing ready for final color trim. If you are still financially solvent, add color dope as desired. Set wing aside in any convenient auditorium so that the dope will thoroughly "cure."

Fin and Stab: The stabilizer is of conventional construction. Two layers of silk with balsa wood in between. The fin is made from a framework of quarter inch square stock, scrap of quarter inch sheet, and diagonals of 1/4" x 3/32". One-sixteenth inch sheet skins each side. Vertical and horizontal flippers of quarter inch sheet.

Fuselage: Make two sides from 1/8" x 6" x 48". Add 3/8" hard sheet nose doublers, and all 3/8" square and 1/4" square vertical and horizontal

members. Cut out plywood and balsa formers. Add 1/4" wing mount supports. Join sides with formers. Add firewall. Add tail post followed by 1/8" x 1" cross pieces. Add top sheeting (grain lengthwise), plywood servo board, plywood fuel tank base, and plywood front sheeting. Hold the latter in place with masking tape until dry. Install the blind mounting nuts for your servos. Finish planking by adding lower sheeting with grain crosswise. Add 1" x 1" soft nose blocks.

The motor mount is fabricated from 1/16" aluminum sheet. If you do not have access to the proper fabricating tools, write the author care of RCM and we'll provide you with one at a nominal cost from a local sheet metal shop. The same goes for the landing gear which is formed from heavier material than is commonly available. The motor mount is held to the 3/8" plywood firewall with four 4-40 bolts and blind mounting nuts. Be sure the top of the motor mount is exactly level with the top of the firewall so that your engine thrust line will be accurately positioned.

Install the fin and rudder. Sand entire fuselage. Fiberglass the nose section of the Digester and paint the firewall and fuel compartment with fiberglass resin. When dry, sand entire structure and cover with silk. Add the fuel tank, landing gear, wing and stab hold down dowels. Finish the ship in your usual manner. If you do most of your flying from smooth terrain, simply run a 1/8" wire axle all the way across the gear spread and through both of the aluminum gear legs. Add a pair of 3-1/2" DuBro wheels. If you fly from a rough, or rocky terrain, use 8-32 stainless or hardened cap screw axles.

Install the radio gear. We simply wrapped the battery pack in foam and inserted it in the first compartment, draped the cables loosely over the ply partition, then wrapped the Kraft proportional receiver in foam and laid it in the second compartment. Servo cables were connected to the three proportional servos which were mounted side by side in the servo compartment. Standard balsa and wire pushrods with DuBro Kwik Links were used to the control surfaces.

Power for the Digester is supplied by a Veco .45. A Veco 8-ounce clunk tank completes the equipment require-

ments. Prop used is a Tornado 12/4. Fuel, KB 100. The original model was finished in the color scheme as shown on the front cover of this issue — orange, white, and black.

Epilogue

Standard first flight trim procedures should be followed. Be sure your plane balances where shown. If it doesn't, add an old pipe wrench or two until proper balance is achieved. Strap on the wing, stab, and gear, then grasp the Digester firmly amidship, just behind the landing gear. Raise to shoulder height, run, and launch into the wind, slightly downward, at a point fifty feet away. Your model should float gently down without any tendency to scallop, or alternately, nose down. All eight or nine pounds of it! Simply remember that you must reach a ground speed of approximately fifty-five miles per hour before releasing the model.

After being satisfied that the Digester glides properly, you're ready for your first powered flights. With a .45 or better for power it has a healthy ground speed. It does steer well, however — the steerable tail wheel is quite effective. As proof, we have two cats, a crow, and a slow moving little old lady from Pasadena to our credit. After the first thousand yards, you might try giving it a bit of up-elevator. If you give it too much, don't worry about it. It won't stall out—it'll simply come right back at you. Inverted. From here on in, you're on your own. You'll find it to be an excellent proportional trainer, plus a highly maneuverable ship that'll do everything in the book.

If you're a real sport, you could try cutting ailerons into the wing. It won't hurt any — but we've never tried it. If you're one of those guys who is still back in the Comet Zipper era, you could even fly this beast on reeds. But proportional is more fun — so what if it does cost \$600 or so? It's for a good cause, isn't it?

And that's the Digester. We think you'll like it. A simple functional design which, although large, is quite fast building, and which combines an inherent stability and forgiving nature with a maneuverability that will please even the most experienced pilot.

You should have no difficulty. Unless, of course, you take this article too seriously. Good flying!

THE AGE OF PROPORTIONAL: REALISM



By MALCOLM DAVIS

*retractable landing gear,
flaps, and mixture control:
how to use the extra
proportional channels*

Photos by Ray Clewett

Long before I built my first single channel model, (a Rudder Bug back in 1952), I dreamt of flying a radio control model. In my fantasies this airplane had proportional control just like the full-scale ships I had flown in the past. It was a great disappointment to me to find that RC'ers were flipping rudders back and forth with escapements and rubber bands, and with a single push button to steer the airplane right and left. Somehow the fever was greater than my disillusionment, and since that time I've run the gambit from escapements to 10 channel reed equipment, with my own single channel proportional system thrown in for good measure. About two and one-half years ago I had settled down to a Stormer with 10 channel reed equipment, and was having a ball. Then people started showing up at the Los Angeles model airport with various types of proportional gear. They seemed to malfunction continuously, and were so expensive that

my emotions toward proportional ran hot and cold. It is disconcerting, to say the least, to see a beautiful Stormer mashed into the asphalt with seven or eight hundred bucks worth of equipment aboard!

Eight to ten months later, however, the picture rapidly began to change. A number of manufacturers were putting out equipment that worked reliably, and people were learning to fly so well that I became totally disenchanted with my reed outfit.

I started looking around for the best proportional equipment available. There is a lot of good gear to choose from, but I decided on the Digimite System that Bonner Specialties was developing. Having watched six of the prototype units operate over a number of months with consistent reliability, the remaining problem was to buy one! My first approach was straightforward — I asked Howard Bonner to sell me one. He refused on the grounds that he was not quite ready

for production. This frontal assault was repeated a few times with the same result. However, I didn't relax my efforts to get a proportional set. I was constantly underfoot, making my desires known, apple-polishing a bit and occasionally I would get turn-sies on Howard's old green and white Pegasus! I doubt if any of the apple-polishing helped, but finally Howard said, "I'll let you use one of the prototypes IF," —

— And that was a **big "IF"!** I was to build a contest caliber airplane with all the normal controls — **plus**, retractable trike gear, flaps, and mixture control! His objective was to use as many of the standard eight proportional channels available on the Digimite equipment as possible.

Having built a fair number of airplanes in the past twelve years, I was fully aware of the size of the undertaking. I chose a Beach-Comber design, scaled up a bit to handle the extra equipment, as the "flying labo-

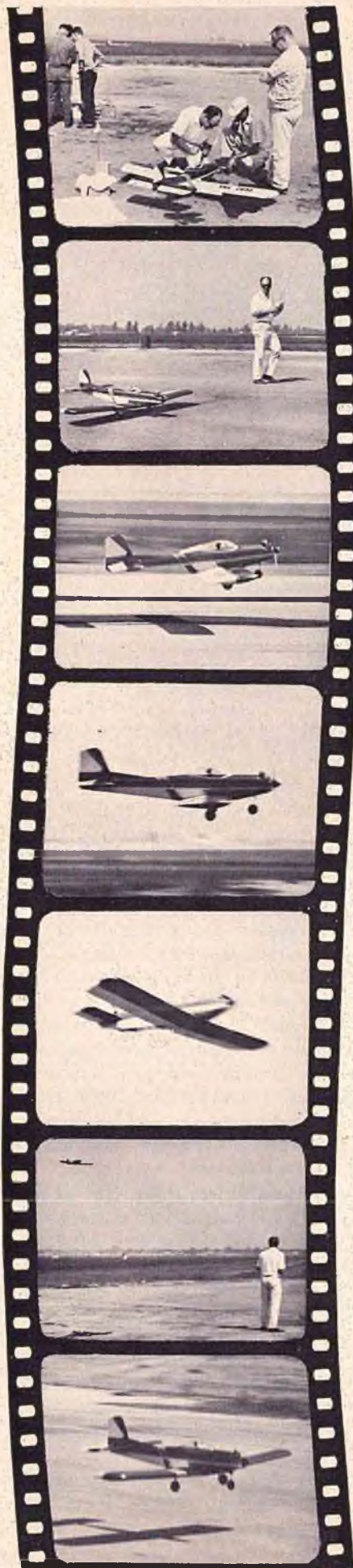

ratory" for this experiment. The span is 66" with 17% airfoil. Total weight ready to fly without fuel came to 9 pounds, 4 ounces — the heaviest Class III airplane entered in the '64 Nationals! A Super Tigre 56 RC was chosen for the engine, because it seemed to be the only mill available with sufficient power that could be easily modified for mixture control. The major problems were (1) to get three servos in the wing (flap, aileron, landing gear) and still have space for spars, ribs, etc.; (2) to modify an engine for mixture control, and (3) to construct a landing gear that would be easily retracted and still take the gaff of landing.

The original flap arrangement is as shown in Figs. 1 and 2. Each flap is 12" long and 1 $\frac{3}{4}$ " wide. The general arrangement should be clear from the drawings and since this is not a construction article, the construction details will be omitted. (The photos show trailing edge flaps, which is a later experiment.)

The flaps were positioned forward, toward the center of lift, for two reasons. First, this is by far the easiest thing to do in view of the strip ailerons, and secondly it was hoped that flaps at this location would have less tendency to change the pitch trim of the airplane when they were raised or lowered. I decided to keep the flap push rod low and inside the wing. The servo was mounted upside down which necessitated building a special mounting bracket. The positioning of the flap servo necessitated positioning the aileron push rods over the top of this unit, somewhat complicating the arrangement of the aileron servo. A special aileron servo bellcrank was produced by Ray Clewett to overcome any problems encountered at this point. The fail-safe neutralizing mech-

anism was disconnected on the flap and landing gear channels, after carefully considering the results of a fail safe condition on landing approach. To have the flaps jerked up when the ship is almost stalled at 10 feet in the air would be disastrous. On the other hand, to have the flaps lowered at high speed, or while doing an inverted 8, is equally frightening! The present arrangement leaves the flaps and landing gear where they are during fail safe conditions.

Experimental modification of an engine for mixture control required a machine shop facility. However, it would be a simple matter for the engine manufacturers to furnish a modification kit for their respective engines. In the case of the Super Tigre 56, we built a new needle valve and needle valve body simply because we could not cut the metric threads to match the stock needle valve and body without buying some special taps and dies. The new parts needed are: (1) needle valve body, (2) needle valve body locking nut with grooved shoulder, (3) needle valve holder block, (4) needle valve, and (5) actuator arm. (See Figs. 3, a, b, c, etc.) The needle valve threads into the holder block and extends through the locking nut and on into the needle valve body. The holder block slides over the locking nut shoulder and is held in place by a screw threaded through the holder block wall. This screw rides in a groove in the locking nut shoulder.

This arrangement of the screw tip in the groove is essentially a threaded mating of the holder block and locking nut that allows an in-and-out movement of the needle valve (which is stationary in the holder block) with a fore and aft movement of the actuator arm. When the actuator arm is held by the servo linkage, the holder

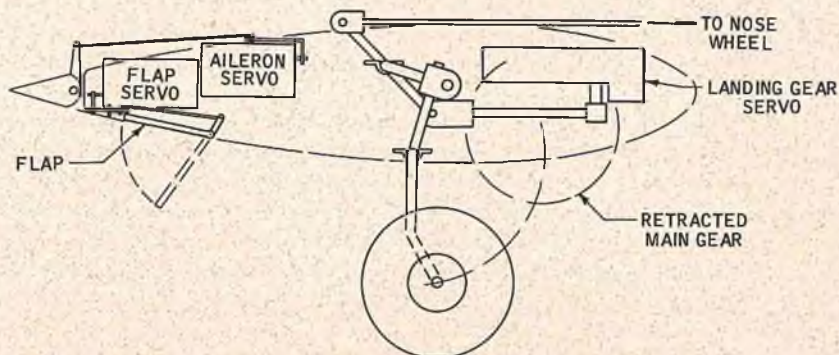

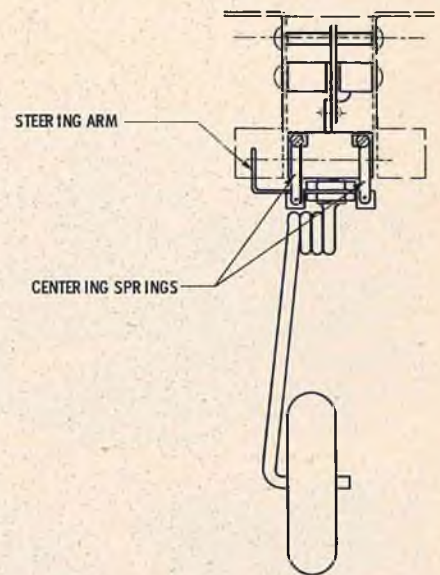
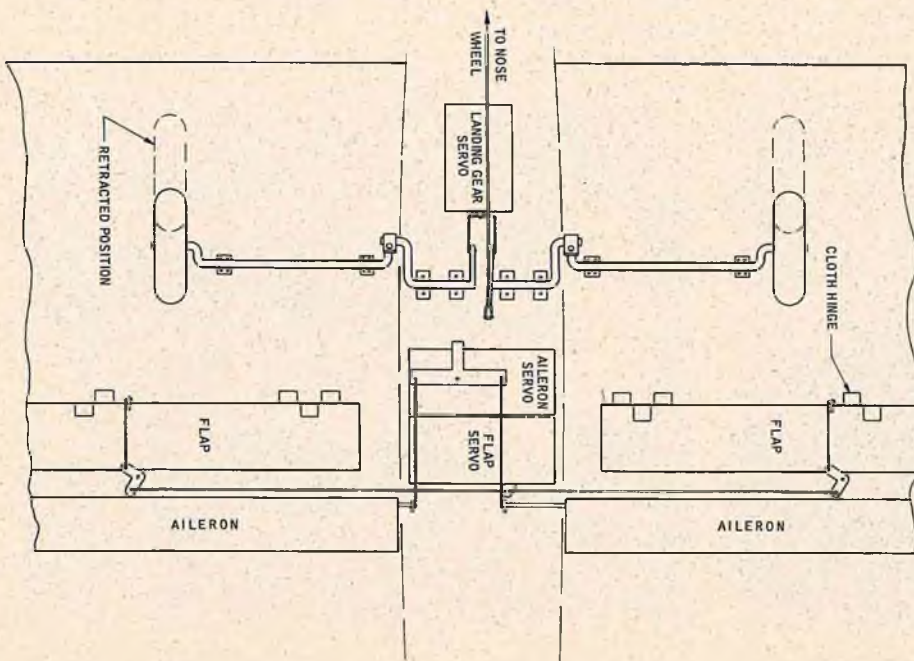
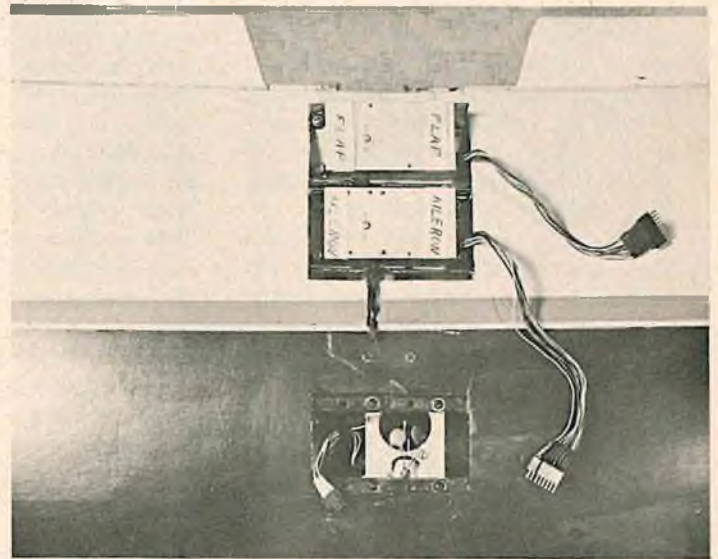
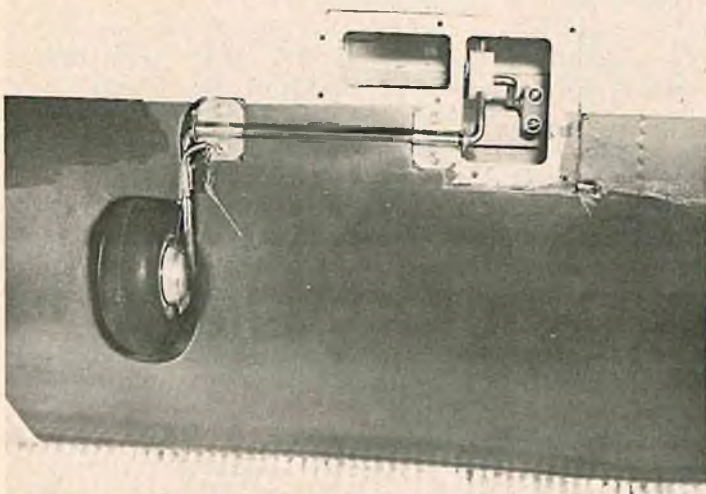
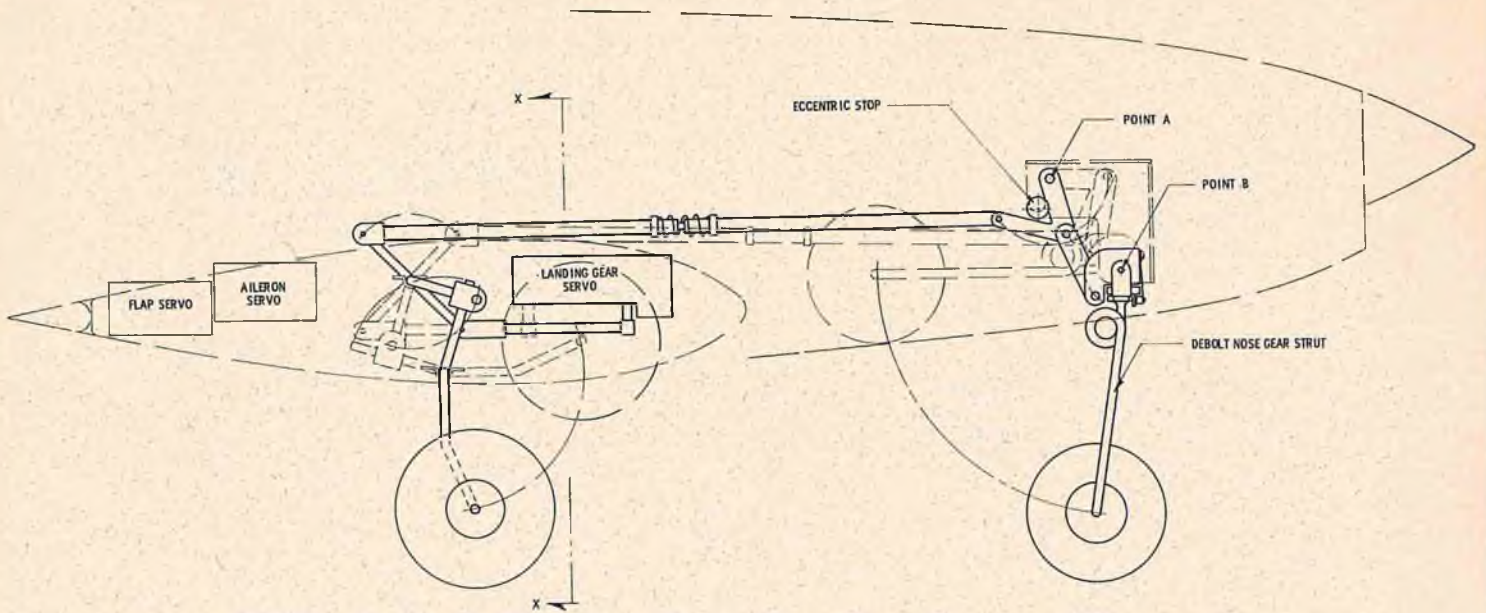

FRONT VIEW OF NOSE GEAR

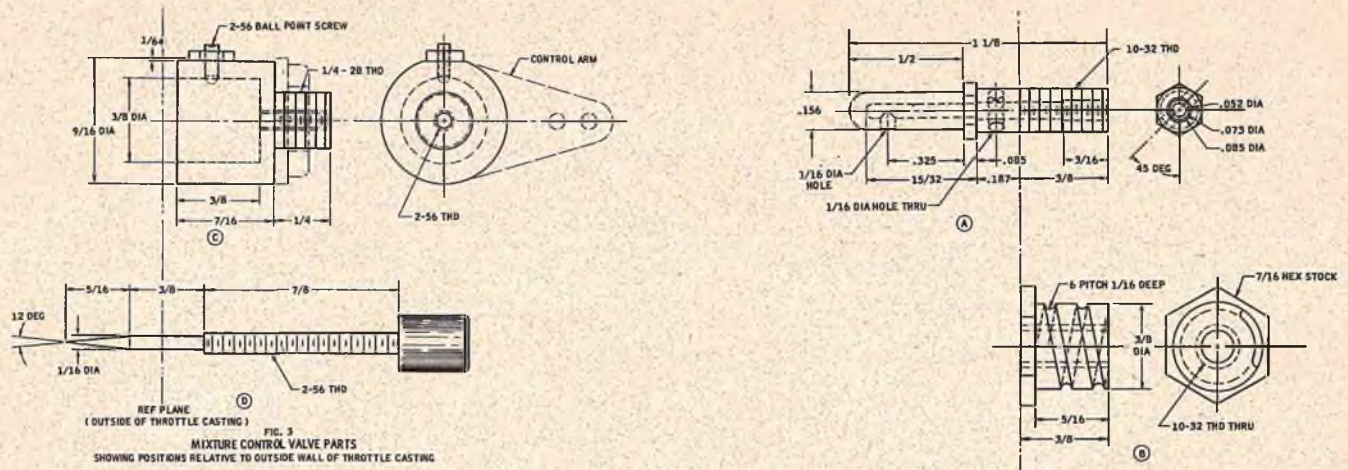

block cannot move. The needle valve is then adjusted by hand in a normal manner, i.e., by screwing it in and out of the block. Friction is provided by a clip from a K & B needle valve to hold the valve in place with respect to the block once it is adjusted by hand. After the needle valve is manually adjusted, a fore-aft motion on the actuator arm screws the needle valve and block assembly in and out with the locking screw riding in the groove, and we have mixture control or "servoed" needle valve adjustment, whichever you want to call it.

The taper used on the new needle valve was very close to the taper on the original. Also the threads used were as close as possible to the metric thread on the original. With the groove cut at a 6 pitch, a 90% motion on the actuator arm gave the effect of $3\frac{1}{2}$ turns of the needle valve, which amount to $13\frac{1}{4}$ turns in and $13\frac{1}{4}$ turns

out. It turns out that this is too much adjustment since you can take it from sagging lean to soupy, sputtering rich with the servo. Our next groove is being cut at 10 pitch to see how this works out. One of the problems in adjusting the needle valve in flight is the inability to hear your engine with other engines running in the area. This problem is greatly reduced with a proportional system since very precise amounts of movement can be specified; however, this doesn't completely solve the problem because the response of engines to a specified amount of control is not consistently predictable.

The conversion of the engine is made by removing the old needle valve and needle valve body and installing the new parts. The throttle linkage that crosses over the top of the throttle is removed and a small arm is put on the right side of the throttle barrel so that

the throttle actuator arm is on the right side of the engine, leaving the left side free for the mixture control actuator arm.

Anyone who has tried to use the Super Tigre R-C engine invariably ends up modifying the throttle in some way to make the engine idle properly. Cliff Weirick, Willie Smith, and Doug Spreng have installed Johnson throttles with excellent results. My experience was very similar — the engine just couldn't be adjusted for both good idle and good top R.P.M. I finally screwed the idle needle valve all the way in, soldered the hole, closed in the idle needle valve, and notched the barrel to get both good idle and peak R.P.M. with one needle valve. This has worked out very well, and is a reasonable thing to do even if you aren't adding mixture control.

(Continued on page 44)

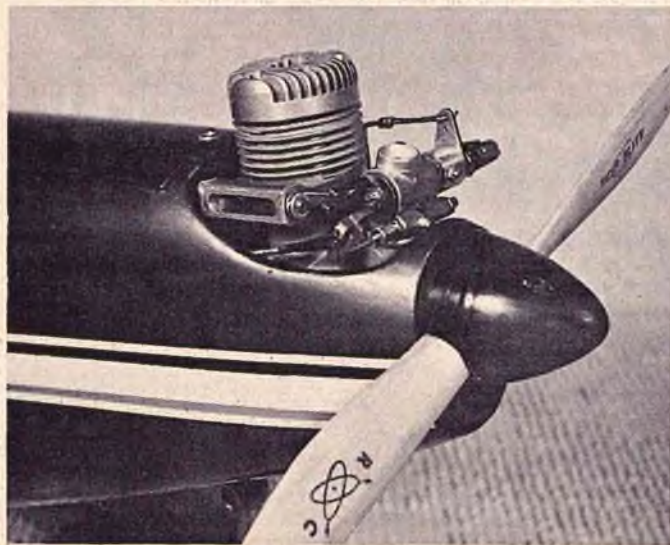

PRODUCT REPORT

BABCOCK BC-22

THE AGE OF PROPORTIONAL

. . . . THE FIRST STEP

In the October 1964 issue of RCM, we reviewed the Babcock BC-21 sport single channel system, designed expressly for the newcomer to radio control, and for the sport flyer demanding maximum reliability at a budget price. Included in this system were several unique design considerations, including an interference-free relayless superregenerative receiver operating at an audio frequency of 6000 cycles per second, and an almost completely pre-wired airborne installation, including the BCR-21 receiver, Mark VII 9-volt escapement, switch and test panel, and battery connection. As reported, and based on our test evaluations, the extreme range, interference immunity, and simplicity of installation, combined with a price tag of under \$50, made the BC-21 an ideal single channel package for the consumer market for which it was intended.

Following closely behind the BC-21 escapement system is the newly released BC-22 pulse-proportional single channel system from Babcock Controls. Unlike many new releases in the R/C field, the BC-22 is not intended to obsolete, nor replace, the BC-21. Rather, it incorporates all of the outstanding features of the "21" while eliminating the rubber-band driven escapement and providing, instead, a magnetic actuator

for rudder-only pulse-proportional flying. Designed for use in small aircraft up to, and including .049 size, the beginner or sport flyer can experience simple proportional flying with complete reliability and without straining the family budget.

As received by our Consumer Research Department, the new BC-22 system was completely installed in an .020 size airplane with 32" span — the D.Q.A. 704, presented in this issue. Subsequent flight tests by RCM's testing staff supported the manufacturer's claims — the system was no more difficult to fly than an ordinary escapement installation, while providing a smoothness of flight unobtainable with the more conventional escapement. The addition of the magnetic actuator presented no maintenance or installation problems. An additional BC-22 system was obtained, packaged as it would be for the consumer, and was installed in another D.Q.A. 704 prototype in less than fifteen minutes.

Transmitter

Insofar as physical differences are concerned, the BCT-22 differs from the "21" only to the extent of a rudder control knob instead of the usual tone key, or button, and the addition of two buttons for "full left" and "full right" rudder control. As with the

10 REASONS WHY YOU* SHOULD JOIN A.M.A.

*RADIO CONTROLLERS!

If you read anything about the Nationals at Dallas this year, you know that the R/C event was a tremendous success. This was due to a very special effort by the Academy of Model Aeronautics, U.S., governing body for model aviation and responsible for the conduct of our annual National Championship Meet. The Academy, in addition to serving modelers in general, is similarly providing special services for radio control.

FCC FUND

An AMA project to support legislation for more R/C frequencies and interference relief.

WORLD RECORDS

Three new world records—Altitude, Speed, Duration have come about from AMA's current efforts assisting record attempts (only AMA members are eligible for records in the U.S.).

NATIONAL RECORDS

FAI R/C TEAMS—Only AMA members may represent the U.S. at world championships. The 1965 team—Weirick, Ritchie, Brooke—won team places at the 1964 Nationals.

SUPERB R/C EQUIPMENT

Present performance and reliability is the direct result of developments from AMA competition. Sport flyers would not have such fine equipment today without the accelerated competition developments.

NATIONAL RECORDS

AMA R/C Pylon flying is an established U.S. national record event. All AMA members eligible.

INSURANCE BENEFITS

AMA members are protected from injury and property damage claims both by fellow members and Sunday flyers, whether at contests or sport flying. Special third party liability available for AMA clubs.

CONTEST CALENDAR

Details of all AMA sanctioned contests in U.S., including local R/C meets, fun-fly sessions and record trials, are sent monthly to AMA members.

R/C JUDGES GUIDE

Every AMA member gets this special section covering maneuvers, interpretations, flying advice for higher scores.

PUBLICATION DISCOUNTS

Grid Leaks, R/C Modeler, American Modeler, Model Airplane News at 15% off to AMA members.

NEW NOVICE/EXPERT BREAKDOWN

For 1965, national standards for AMA contests to permit novices to fly against their own class competition. Up to now, only a local option.

How to Join:

Your license classification is based on your age as of July 1, 1965.

JUNIOR LICENSE (including 15 years)
SENIOR LICENSE (16 through 20 inclusive)
OPEN LICENSE (21 years and over)

Please enter me on the membership roll of the Academy of Model Aeronautics.

I enclose \$.....
Junior \$3.00 R
Senior \$4.50 C
Open \$6.00

Date of Birth

Name

Street

City and State

Mail to: ACADEMY OF MODEL AERONAUTICS
1025 CONNECTICUT AVENUE
WASHINGTON 6, D.C.

BCT-21, the RF section is composed of a drift transistor running in a crystal-controlled oscillator with an input of 18 volts, but using four 9-volt transistor batteries wired in series-parallel instead of the two 9-volt units used in the "21" — the additional power supply required for the pulser section. Again, this is a Part 15 transmitter, using a 6000 cycle modulation frequency. The tone is generated by a variable frequency multivibrator, adjustable at the front panel of the transmitter for peak tuning.

The modulator is the same high level, series type, using no transformer, and with excellent response at 6 Kc. Modulation is approximately 90%. The same simple wire antenna, utilizing twin loading coils, as used on the BCT-21 is used on the newer BCT-22.

The pulser utilized is all-transistorized, running at a 12 cycle per second rate with a duty cycle from 20/80 to 80/20. A separate transistor is used between the pulser and audio oscillator in order to key the latter — a major advantage in that it does not upset the pulser by unsymmetrical loading.

The proportional rudder control knob uses no form of self-centering, a feature that has proven to be completely adequate for simple pulse-proportional flying. The radius of the rudder control knob is 270 degrees, allowing a wide range of control as a safety factor for the beginner. The "full right" and "full left" buttons allow maximum rudder deflection for stunting, or for "bang-bang" rudder action equivalent to that provided by an escapement.

Test Data

Voltage: 18 volts (four small standard transistor batteries wired in series-parallel).

Currents: (Antenna extended) 30 Ma average; (Antenna removed) 28 Ma average.

Waveform: Multivibrator almost sine wave at modulator.

Stability: Excellent.

Temperature Stability: Very slight audio drift but transmitter and receiver stay together with no variance.

BCT-22 Physical Data

Size: 6" high x 3-9/16" wide x 1-15/16" deep. Rudder knob projection 1/2".

Weight: 16 ounces.

Antenna: 34 3/4" extended, including both loading coils. Consists of three sections of 3/32" wire.

Case: Rugged steel construction, blue and white finish, silk-screened Babcock Controls trademark.

Controls: On-off slide switch, rate control knob, tone adjustment, full right, full-left buttons. Back is removable, and secured in place by four sheet metal screws.

Manufacturer: Babcock Controls Inc., 2762 Laguna Canyon Rd., Laguna Beach, Calif.

Price and Availability: Not sold separately. Entire system currently available direct from the manufacturer.



Receiver

Similar to the BCR-21, the BCR-22 receiver contains a superregenerative detector of a highly stable type. This, in turn, is followed by two amplifiers, each of which is composed of a pair of transistors in a circuit similar to the Darlington configuration with an inverse feedback filter. This pair of amplifiers gives an extreme degree of audio selectivity and completely eliminates the great attenuation normally needed to eliminate quench frequency. Unlike the BCR-21, however, the last two transistors radically differ from the ordinary receiver. These are used in a grounded emitter configuration to minimize typical temperature problems associated with relayless receivers. The audio rectification in these two transistors permits a well-defined pulse rate. The usable sensitivity of this receiver is again considerably better than 1 microvolt, due to the very narrow audio bandwidth, and shows an increase over the BC-21 system due to the pulsed signal.

Sensitivity is excellent, offering the same interference immunity as its predecessor due to the high audio frequency. (Ref. RCM 10/64)

BCR-22 Test Data

Voltage: 9 volts for entire airborne system (two 9 volt transistor batteries in parallel).

Currents: 35 Ma constant signal.

Tone Frequency: 6000 cycles per second.

Peak: 5600-6400 CPS adjustable at transmitter.

Sensitivity: Better than 1 micro-volt (usable).

Interference: With carrier on, the receiver was immune to any form of noise, adjacent channel interference, CB voice interference, or from radiation by another receiver regardless of proximity of adjacent units.

Combined Range Check: 4700 feet consistent ground range. Manufacturer guarantees 1500 feet minimum.

Swamping: None, regardless of proximity of receiver to transmitter.

Temperature Stability: Response was flat from 30 to 120 degrees F.

BCR-22 Physical Data

Size: 2 1/2" length x 1 5/8" width by 1" depth.

Weight: Entire airborne system, including receiver, PA-9 proportional actuator, two 9 volt batteries, harness, switch, and wiring: 5 ounces.

Antenna: 18" vertical wire whip, or standard hook-up wire equivalent.

Case: None.

Manufacturer: Babcock Controls Inc., 2762 Laguna Canyon Rd., Laguna Beach, Calif.

Price and Availability: Not sold separately. Entire system price, including transmitter, receiver, PA-9 magnetic proportional actuator, and wiring harness \$59.95.

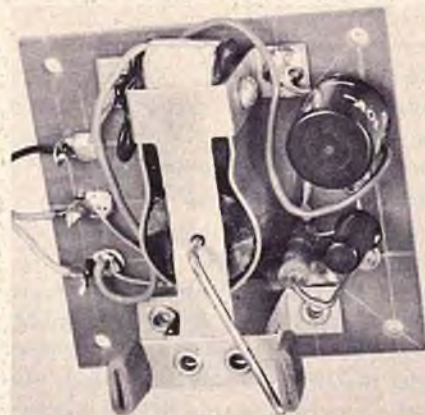

(Continued on page 46)

PRODUCT REPORT

MIN-X PULSEMITE



THE AGE OF PROPORTIONAL

. . . FLYING ON A BUDGET

One of the newest offerings from the Min-X Radio Corporation is the Min-X Pulsmite 1200S, Model TCPT-1 transmitter and its companion unit, the Min-X Superhet 1200, Model SHS-1 receiver. Designed for single channel proportional operation, this matching transmitter and receiver should gain wide acceptance among pulse proportional fans.

For our test purposes, and as illustrated in the accompanying photographs, a S.E.P. Go-Ac galloping ghost actuator was employed as the servomechanism. Six alkaline energizers and a quadruple pole, single throw switch completed the airborne system. For

proportional rudder-only operation, any of the available magnetic actuators or popular Mighty Midget motor can be used. For galloping ghost, it is recommended that an actuator employing the Mighty Midget motor, such as the Go-Ac be employed.

The first general impression of the Min-X 1200S transmitter and receiver is that the packaging of the units has reached an all-time high. Upon further examination, it was discovered that the consumer appeal generated by the packaging was exceeded only by the high level of mechanical engineering involved in both the transmitter and receiver. It is quite apparent that these

units are the result of no small amount of electronic and mechanical design consideration.

Transmitter

The Min-X Pulsmite 1200S all-transistor transmitter was designed to operate the Min-X 3-volt Superhet 1200 audio frequency selective receiver, and incorporates a frequency stable, 1200 cycles per second audio frequency tone generator to match the frequency stability requirements of the Superhet 1200. The electronic pulser was designed to provide the pulse rate and width variations necessary for galloping ghost operation using the Mighty Midget motor for the servomechanism. For rudder-only proportional fans, a magnetic actuator or Mighty-Midget motor may be used as a single function servo, or in conjunction with a pulse omission detector for motor control.

The Pulsmite 1200S incorporates six control devices. The first is an off-on power switch which connects the 9-volt transmitter battery power to the pulser, audio oscillator, and RF sections of the transmitter. When this switch is "on," the transmitter is emitting an RF carrier with audio frequency modulation periods generated by the pulser and tone generator.

A very unique control stick is provided which controls two separate functions. Moving the stick right or left creates variations in the pulse width ratio. A forward movement (down elevator) causes an increase in pulse rate,

(Continued on page 47)

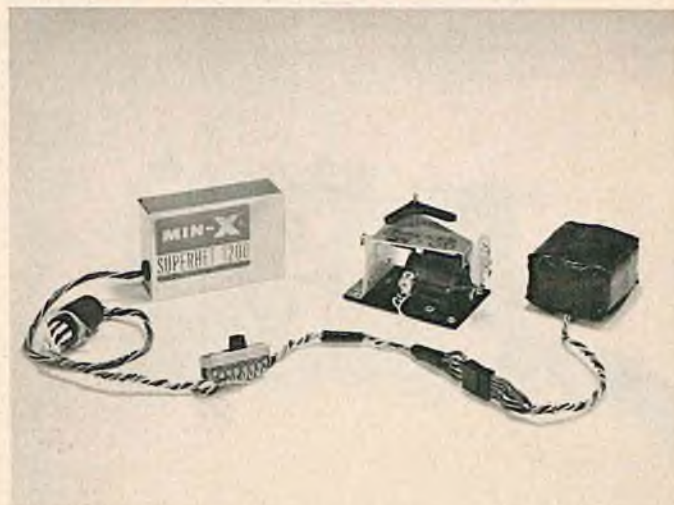
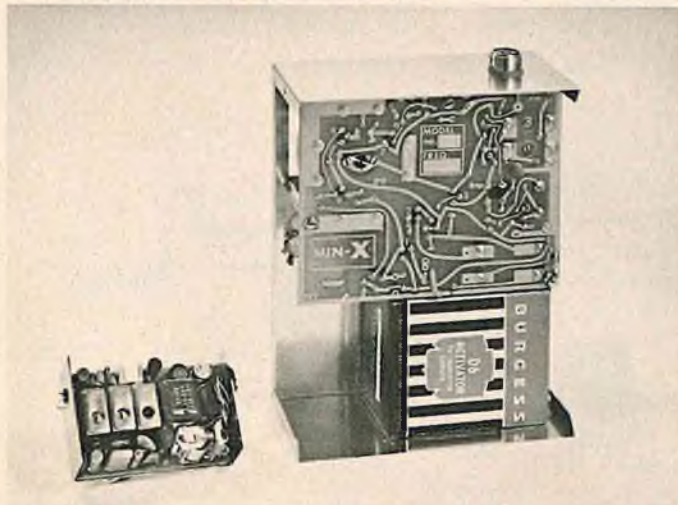

THE AGE OF PROPORTIONAL

KRAFT PROPORTIONAL SYSTEM

A NEW CONCEPT AND A NEW STANDARD



Scheduled for full production after January 1st, the new Kraft quad proportional system represents, in our opinion, a major breakthrough in the field of proportional control. Although in no way similar to the earlier Kraft-Pullen proportional system, the new model, designed by Don Mathes, is a joint production engineering effort of Phil Kraft, Don Mathes, and Jerry Pullen, and represents an accumulative experience factor of twelve years in the field of proportional control.

With a pilot production run of twenty-five units now in process, we were fortunate enough to flight test one of these new models, using the 'Digger' design featured in this issue. To say that this was a new experience in proportional flying would be an understatement. From first appearance through a full day's flying

it was apparent that we were working with an entirely new concept in this comparatively new realm of radio control.

Basically, the Kraft proportional system consists of a four-channel, "digital" system which enables the flyer to obtain full control of rudder, elevator, aileron, motor, plus individual trim of all functions. For all intents and purposes, the completely pre-wired and pre-cabled airborne installation looks exactly like a reed installation. In fact, the entire proportional receiver is enclosed in the standard Kraft ten-channel receiver case. The battery pack is the standard size of the ten-channel system. The four servos, with self-contained closed loop amplifiers, are between the Anco and Bonner in physical size, and feature completely linear travel. The

Kraft proportional servos put out approximately three pounds of thrust with a total linear travel of $5/8$ ". A continuous position repeat is accurate to one-half to one percent of total travel! Trim is equivalent to ten percent of the total travel. Unlike the majority of proportional systems available today, trim is used only for first-flight convenience. Once the model is properly trimmed out, only elevator trim is used. Unlike some competitive proportional rigs it is not necessary to re-trim due to environmental variations. This major advantage of the Kraft system is due to the fact that there is absolutely no drift whatsoever over the complete temperature range. Environmental changes have absolutely no effect upon the centering which remains constant.

The transmitter is a two-stick sys-

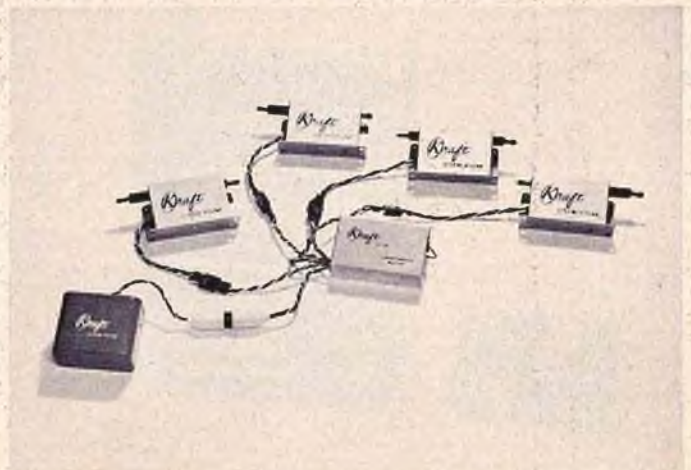
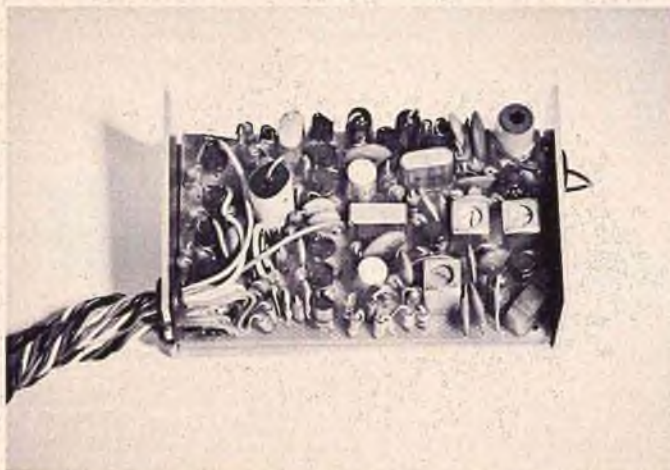

tem, factory set-up with control functions located as desired by the purchaser. The normal stick function has the elevator and aileron on one stick with the rudder and motor on the other. With this method, the flier is for all intents and purposes, flying a single stick system. Although the final transmitter power supply configuration has not yet been established, our model was equipped with nickel cadmium batteries (600 Mah pencils) and a charging socket at the base of the transmitter itself.

The new Kraft quad proportional is unique in many ways and will undoubtedly set a design precedent for proportional systems of the future. The most noticeable difference from competitive systems is the overall simplicity. Since it is a known fact that proportional problems or failures increase as the number of components are increased, it is interesting to note that this new quad system uses approximately 50% of the components used in the original Kraft-Pullen design — and less than any competitive system currently available. This inherent design simplicity not only provides the flier with an increased reliability potential, but is also a major

asset to the manufacturer from the standpoint of production. With respect to the latter, this system is what is known as "repeatable" — that is to say, each unit manufactured will be exactly like the one before it, and will perform in the same manner. To date, the majority of proportional rigs are, in effect, "custom" units. With regard to the components used, the new proportional receiver uses only seventeen transistors. The relationship of potential failure to the number of components used is a known mathematical equation — double the number of components and you have four times the trouble.

Another notable difference in the Kraft system is the complete absence of "lockout" and "fail-safe". As the current controversy goes on as to what form of fail-safe should be incorporated in proportional systems, we were quite surprised to find a system that does not utilize this principle at all. After a thorough analysis of this problem, however, it becomes apparent that there are two sides to the question.

As an example, when erroneous, or "outside" information such as interference, is received by most propor-

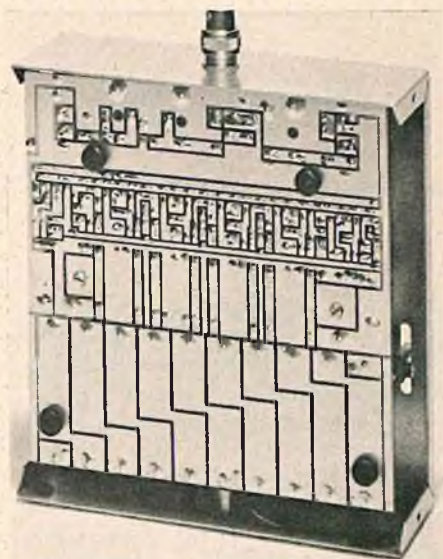

tional receivers, the receiver will "lock out" — that is to say, they remain for a brief period at the last given command, then go to "fail-safe", in most cases, neutral. This then, describes an inability of the system to discriminate between, or reject information other than that transmitted by the pilot, thereby causing the pilot to lose control over the ship. The new

(Continued on page 59)



O.S. MAX

OS R/C equipment has had a long and extensive development period. Their new all-transistorized line of receivers and transmitters feature powerful and stable circuits. All of the small hardware on the transmitter is chrome plated, the transmitter (12 ch.) comes with leather case. Construction and finish — inside and out — are extremely well executed.

OS engines are made with the same care that is pampered on the R/C line. More parts are hardened, ground and polished on OS engines than on many other engines. Also, at the OS factory each engine is actually started up with a special test prop. Check the latest improvements on OS engines — see the latest World Engines Catalog for details.

World Engines — Exclusive U. S. Importer of OS Engines Assignee of OS Trade Mark. U. S. Patent Office No. 680,368.

World Engines, Inc.

8206 BLUE ASH ROAD — CINCINNATI, OHIO 45236 — U.S.A.

O.S. Engines

| | |
|----------------------------|---------|
| Max 60 R/C | 22.98 |
| Max 40 Std. | 16.98 |
| Max H35 Combat | 18.98 |
| OS Mark III Jet | \$19.95 |
| Max 50 R/C | 35.00 |
| OS 50 Std. | 27.98 |
| OS 50 Throttle | 6.98 |
| OS 50 Throttle Parts | .65 |
| Max-S 35 Stunt | 13.95 |
| OS 29 Speed | 11.98 |
| Custom "X" 29 | 9.98 |
| Max 29 R/C | 14.98 |
| OS 29-35 Throttle | 4.98 |
| Max 19 | 10.98 |
| Max 19 R/C | 15.98 |
| OS 15-19 Throttle | 4.98 |
| OS 19 Marine | 15.98 |
| Max 15 III | 10.98 |
| Max 15 R C | 15.98 |
| Pet .09 | 5.98 |
| Pet .09 R C | 6.98 |
| Max 06 | 8.98 |

O S R/C

| | |
|------------------------------|--------|
| 1 Ch Pixie Tx | 19.98 |
| 1 Ch Pixie Rx | 11.98 |
| 12 Ch Tx | 109.98 |
| 12 Ch Rx and S/Het | 89.98 |
| 6 Ch Tx Simul and Case | 89.98 |
| 6 Ch Tx S70 | 69.98 |
| 6 Ch S/Het. Rx | 53.98 |
| 1 Ch Tx for S/Het | 43.98 |
| 1 Ch Rx S/Het | 32.50 |
| OS Rudder Servo | 13.98 |
| OS Motor Servo | 12.98 |
| OS 7 Pin Connector | 1.29 |

O.S. Escapements

| | |
|--------------------------|------|
| OS K-1 Compound | 8.95 |
| OS K-11 Compound | 8.95 |
| OS SS-2 SN w/yoke | 5.95 |
| OS S-2 Claw w/yoke | 5.95 |
| OS S-4 Claw w/yoke | 5.95 |

| | |
|---------------------------|------|
| 19 Marine Universal | 1.25 |
| OS 15/19 Muffler | 2.98 |
| OS 29/49 Muffler | 3.98 |
| Pet R/C Throttle | 1.00 |
| Max 35 Pr. Fit | .50 |
| Max 15 Pr. Fit | .50 |
| OS 29-49 Spinner | 1.99 |
| OS 15-19 Spinner | 1.89 |
| 2000-7000 Tach | 1.75 |
| 8000-16000 Tach | 1.75 |

EDITOR'S MEMO

(Continued from page 8)

But, what impressed us even more was a letter of policy received at RCM from Babcock Controls concerning the Digitran system.

If you read this company's advertisement in this issue, you will find out, as we did, that any modeler who purchased the BC-18 Digitran system may return this system to the manufacturer — and that a completely new design receiver plus a modified transmitter will be returned to you at absolutely no charge, whatsoever!

And this is what a guarantee means to one manufacturer. Even though he was not personally responsible for the design of a given system, he feels a responsibility to the modeler who is unhappy with an item marketed by a company that retained the use of his name, and subsequently, is willing to discharge this responsibility at quite a considerable personal expense.

This is an example of personal integrity on the part of an individual member of the hobby industry. It is representative of a close manufacturer-modeler relationship. We are proud to present this company's advertising, and to review their products. We are also proud to be part of an industry where the manufacturer feels his long-term relationship with the individual modeler is more important than a short-term monetary profit.

The word "guarantee" has taken on a new meaning.

Some publications call it "errata" — with us, it's just plain old goof. And when we make 'em, we make 'em! Our sincerest apologies to Glaskraft, manufacturers of the fiberglass Candy, Viper, Talon, and Robin fuselages. Their correct address should be 324 Walnut, Arroyo Grande, California, and not Santa Ana, California as listed in the November issue.

Also on page 36 of the same edition, an unfortunate typesetting error occurred in the advertisement for Ski-

Glas, manufacturers of fiberglass Falconaire, GlasSquire, and Yellowtail fuselages — their correct address should be P.O. Box 2281, Santa Ana, California, and not Santa Barbara, as published.

Again, our apologies to Max and Bing — we really don't have anything against manufacturers of fiberglass fuselages — it was just a coincidence. Honest!

A note or two concerning the Builder of the Model Rule — the old controversy still rages, and this writer, for one, feels that insofar as R/C is concerned, this rule should be relegated to the Dark Ages from whence it came. Let's be realistic — ours is primarily an adult hobby. We hear the moans and wails about the lack of contest participation, and then try to tell an adult he can't enter a contest with any of the fine prefabricated wings or fiberglass fuselages he sees advertised in this and other publications. Any adult modeler is going to build and fly any type or form of model he pleases, and is not about to be dictated to by any other group who is still in the banana oil and tissue paper era. The concept of a top contest pilot having to demonstrate his "proficiency" at building a model is ludicrous to say the least. Obviously he can build a model or he wouldn't be where he is today. It takes years of continual practice and experience to become a proficient contest pilot, and obviously he's built a lot of models in the past — they didn't have prefabricated models in the days when he got started!

Whether we like it or not, the age of prefabrication is here. In the coming months you will see more and more of it, including complete ready-to-fly airplanes with full-house equipment installed. If you personally don't like the idea, you certainly don't have to buy them. But, by the same token, the man who does has every right to fly them, and if he wishes, to compete with them. I have flown with fiberglass fuselages, prefabricated wings, and complete, ready-to-fly multi ships — they have certain definite advantages. I also like to build my own aircraft from scratch to finish, simply for the pride of accomplishment. This is a country where every man has a free choice, and if rules are going

to be enforced as to who can fly what and where, for the benefit of some to the exclusion of others, then it's time we take a good, long look at our hobby and where we're headed.

Welcome aboard to Jerry Kleinburg and Don Mathes, RCM's newest staff members. Jerry, one of the top rudder devotees in the country, commences his monthly column, 'Top Out', in this issue. Those of you who think Class I is for sissies, read on! From beginner to expert, rudder only fans will find a wealth of material in Jerry's column.

Don Mathes makes his first contribution with the 'Digester' in this issue. Don has been around RC circles for quite some time and is a former world's record holder in R/C speed, a top competition pilot, and currently, the designer of the Kraft proportional system. On top of all that, he's our only pipeline to the Northeast Corner Bowery Boys — a small but elite group of fliers who are becoming a legend in their own time. If you spot one of their planes — marked with a small bowler hat and beer mug — watch it! This group is so tough they even thought about challenging the Untouchables plus Dart and Sons to a few rounds of nighttime combat. We understand one of the members has an all-black ship complete with needle nose spinner and razor blades imbedded in the wing tips — makes low passes over pine trees and trims the branches for practice! You'll hear more about this group as soon as their PR man gets out. Of jail.

Since you'll receive this issue around the middle of November, Happy Thanksgiving. But, since it's our December issue, Merry Christmas. No matter how you slice the bird, they're both ahead and we wish each and every RC'er and member of the industry a very, very happy Holiday Season.

Even the Bowery Boys.

And if you're beginning to worry about that new sixteen channel proportional rig you ordered for your wife for Christmas, just remember — she may have bought you a new mink coat!

Gone, but not forgotten...



INTERNATIONAL Circuit

By Cliff Rausin

GREAT BRITAIN

The big news from England, according to Geoff Franklin, is the result of the R/C team selection Finals for the 1965 Internationals. Sunday, October 11th, the date of the final team trials, started off with a thick fog followed by rain. After three flights by each entrant, the top two counting for score, the final flyoffs were held. Standings at the conclusion saw Stewart Foster, first; Chris Olsen, second; Frank Van den Bergh, third; Pete Waters, fourth; and Geoff Pike, fifth. Unofficially, it would appear that the first three will constitute England's team for the '65 affair in Sweden, although final selection could officially be made from the first four placings. In any event, it would seem that GB is fielding the strongest team they have had to date.

Of the Finals entrants, only Geoff Franklin and Geoff Pike were flying proportional systems, the former using an Orbit and Peik flying and F&M. Franklin's ship is his own One-O-One with Merco 61. Pete Waters was flying the Altair design with Merco 61 and Min-X reed equipment. Stew Foster's Nimbus was equipped with Orbit reed equipment and another Merco. Frank Van den Bergh also used the Orbit reed and Merco 61 combination. Den

Stew Foster



Allen — "Mr. Merco" — should be quite pleased with the reception for his outstanding new mill.



Frank
Van den Berg



Joan and
Pete Waters

With the number of full house proportional systems increasing rapidly in the U.S., it may seem strange that only two such rigs were used in the British Team Trials. It must be noted, however, that duty and tariffs imported on a 600-\$700 American system will raise the price to over one thousand dollars by the time it is landed in Great Britain!

CANADA

The Toronto Radio Control Club's 9th Annual R/C Contest, held September 12th and 13th,

was marked by the best flying weather of the year, and included both radio and television coverage of the two day event.

Class I was won by Barry Fletcher of Prince Albert, Ontario with an original rudder only design housing Controlaire 10-channel equipment. Paul and Reg Noble were second and third, respectively, with Jetco Krackerjac's.

Mel Hall, with his first attempt at contesting, won Class II with a Tauri. Brad Savage was second with an original design powered by a KB .35. Ray Eardly, TRCC prexy, was third with a Stormer, sans ailerons.

In the hotly contested Class III division, Murray Chercover was victorious with a Norseman (RCM plan). Ron Chapman, designer of the winning ship, was second with another Norseman. After two days of flying, Chercover aced out Chapman by only one point! Warren Hitchcock of Oakville was a very close third.

With scale entries high due to the popularity of this event in Canada, Ken Dwights Hawker Hurricane emerged in first place. This not only is fully scale, but is capable of the entire AMA pattern! Elmer Nowak's Gypsy Moth was second in this event, and Ty Williams was third with another Nowak designed Moth.

SWITZER- LAND

The Swiss Multi Nationals, this year, was won by Claude Sauthier of Geneva, using an F&M Hercules/Midas reed rig and an original design R/C model. In second place was Kurt Messmer of Frauenfeld with Kraft 10 and a Taurus. Third place was won by last year's Swiss national champion, Bernhard Huber, using a Kraft 10 and Sabre Hawk design built from the September issue of RCM. Among the ten finalists in the multi competition, five entrants were using Kraft reed equipment, two F&M Matador's, one F&M Hercules, one Hetzel Proportional, and one home made rig.

At the International Contest at Bendorf, Klaus Fuchs of Munich took first place with a Stabo Proportional and flying a Taurus. Second and third positions were captured by Bernhard and Gerd Huber of Fehraltorf with Kraft reed equipment and their jointly-designed Mark Seven.

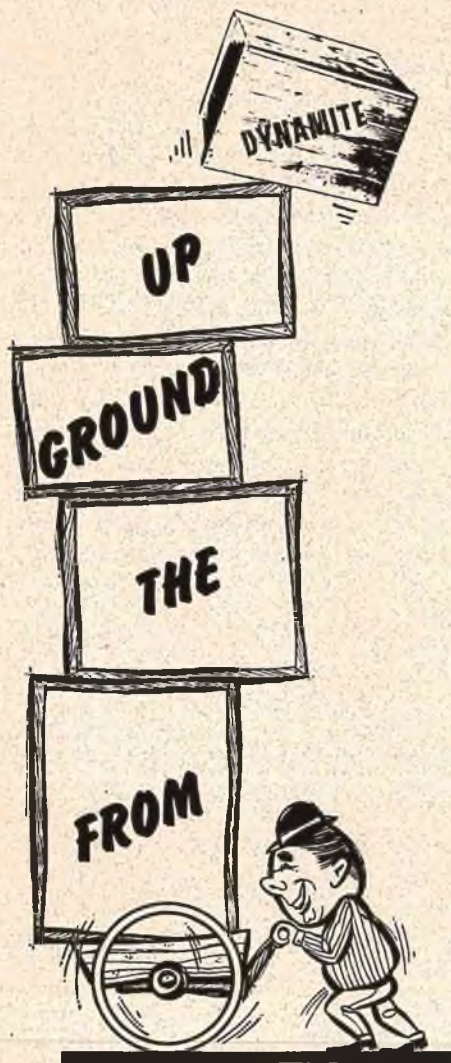

TED STRADER

Discovered... a method of torture superior to letting water drip in a rusty bucket! Try to write a column with a C-G system being checked at the same desk!

Some Wag will suggest turning it off! He's the same clown who will spend two hours chasing flies up a screen door. My wife, upon successfully infiltrating my sanctum sanctorum (really a converted water closet), overheard me remark that the chatter would drive me crazy. She, in her sweet little way, corrected me to the effect that that wasn't a drive... just a short putt!!!?

So why all the rumpus? Why not turn it off? If I did that, I'd never know which was superior — man or machine? What started out as a simple check has blossomed into an en-

durance test. The object was to see which will give out first, my mental composure or the physical stamina of the combined team of a new Min-X Pulsmite 1200S transmitter and superhet receiver operating the equally new AGS Super Go-Ac. Frankly, I'm about to toss in the towel and give "machine" the benefit of the doubt!!

Seriously, this was not intended to be a full-scale experiment. The transmitter, receiver, and battery pack is the same used in RCM's appraisal of this system tied to a regular Go-Ac and reported on in this issue. The entire rig was sent on to me for a closer evaluation. I simply removed the Go-Ac and wired in the new, soon-to-be-released model to see how it would operate. No additional components used—as they say at Cape Kennedy, "All systems operating A-OK!" I can't give a servo battery report as I don't know how long the four pencil cells were used during RCM's test — they've been doing a splendid job here for a couple of hours. (Ed.'s note: The sixth cell in the pack is a dynamite cap. At two hours and fifteen minutes the motor arm will swing to its full extreme. Then...)

The Min-X rig is ultra! Just like silk! The question raised in my mind was if the superhet receiver would accept the type motor being used in the new Go-Ac. Min-X's instructions specifically recommend using pulse actuators which use Mighty Midget motors, inasmuch as their "noise" level is low. Previous tests showed that the new motor being used in the AGS S-G-A had a similarly low "noise" level and had been working fine with three different superregen receivers. The new one has passed the test with flying colors and graduated Magnetic Cum-Spring Lauded.

In the mail department, this was a month for extremes — Extremes at approaching the mystifying hobby of radio control. For example, it's been a long time since we've received a letter from an interested beginner who wanted to start with a four-engine bomber on 12 channels with flaps extended, machine guns blasting, bombs dropping, and electrically controlled variable pitch props!

By the same token, it's been even longer since receiving a letter such as

was sent by Art Coppock of Littleton, Colorado. We'd like to share the substance of it with you. And, while it may seem like a cumbersome way of entering our hobby, it is certainly thorough and well thought out.

Through the influence of a friend who flies R/C, Art has become interested in what seems to him to be a hobby he and his young son could enjoy together. With the thoroughness of a computer programmer, he has laid out the following modus operandi:

(1) Build and fly a free flight model to get the "feel" of construction and trimming of a rubber band type flying model.

(2) Build and fly an engine-powered free-flight model to become acquainted with model engines.

(3) Build and free-fly a ship designed for rudder only R/C, less its R/C components.

(4) Install R/C equipment in this model.

For one who is not only unfamiliar with R/C, but unschooled in the art of model airplane construction and flight, this seems to be the only sensible course to follow. Sure, it's slow...but also thorough. There is the added advantage of such a snail's pace in saving money on equipment which might become totaled during the preliminary schooling!... 'Course, this may happen anyway! But, at least an attempt is planned to eliminate some of the risk.

Steps 3 and 4, naturally more exacting and demanding than 1 and 2, will require a liberal dose of common sense during model balancing adjustments. While most R-O type R/C models would fly free flight if balanced properly, they are usually designed to balance more easily with equipment installed. The smaller the R/C ship, the more the equipment placement will determine proper balance. This is usually due to the limited space requiring utilization of every square centimeter in which to stuff the gear. Larger models are frequently easier to balance because the bulk of the R/C gear will usually fit in one compartment near the balance point.

Something else to keep in mind is the power requirement. If your test model, sans R/C gear, tips the scales shy of the mark where the same ship

(Continued on page 69)

Call it mental telepathy, or for the practicing cynic, two minds in the same rut, but welcome — welcome to TOP-OUT which is to be devoted to Class I news, comments and some et cetera. The mental telepathy bit, in case you're wondering, comes about by what some would consider an adroit move by Ye Olde Editor, Senor Don.

One evening, an amazingly short time ago, this happy RCer was chewing up some balsa when Emily, my faithful cleaner-upper (wife to non-modelers) noted, without looking up from her sewing, "instead of growling around you might as well start that new model you've been hinting about and get in a better mood." Considering this means we eat off the snack bar in relays or stand-around for about five weeks, (since I take over the kitchen table for construction projects), you can appreciate the sacrifice this suggestion entails! It's not really that, I inform her, leaving an inferred loop-hole open for taking up the model building offer later, but explain the noise is only a venting of concern on a few matters about which I ought to write RC Modeler. Tersely I'm told to write, already!

Such is the idyllic scene when a call comes through from the Don himself suggesting a regular column focusing on various aspects of Class I. So here we are — but there's a question bothering me—how do I grouse now that he's the boss? And so, here's the column...

TOP-OUT, as the name suggests will attempt to raise Class I matters above the clouds of confusion and sectional blind-flying, and keep to bright, clear air by providing fresh news and a forum and voice for our segment of RC flying. All aspects of rudder-only will be covered here from beginner to contest-expert, from rubber band to transistorized servos. To do this completely, and effectively, your news, views and just-plain-letters are asked for, along with items of club activities and contests. Send your contributions to TOP-OUT, care of RC Modeler. The policy here will be as in the rest of RCM — the news first, most complete, and of, for, and by RCers. **Petri Wins Four More in Texas**

H. C. "Pete" Petri, 2nd Place NATS Class I winner, followed up on this



Mel Santmeyer of Detroit, Michigan, and his outstanding Class I original. These and accompanying photos illustrate the design trends in Rudder Only.

by jerry kleinburg

well-earned effort by taking first place in four RC contests in Texas. In quick order, sanctioned meets in Austin (August 9), Lake Jackson (August 31), Dallas (September 6) and Houston (October 4) saw the familiar red, white and black modified Mambo that Pete calls "Air Conditioned" delicately pattern through Texas sun and soft breezes in typical Petri fashion to handily take top honors and hardware.

Pete, whose balsa dust piles up in San Antonio, continued to use the same plane and equipment seen at the NATS last July; a McCoy 35 ("almost like cheatin' to use an engine costing less than 11 bucks," says Pete), Bonner transmits and Citizenship 10 Channel RX and TX. It's rumored Vernon McNabb is planning to give Petri stock in Citizenship — it may be cheaper than the equipment certificates Pete is picking up regularly by using Citizenship equipment in making his wins! (Seven firsts this year beating his six of last year!). Anyone who has seen the Petri flying style agrees Pete's the one to watch in '65.

The San Antonio Story

San Antonio, along with several other favored areas, has a year round flying season. This allows testing of new planes and ideas when contest activity slows from November through March. The main idea trend for Class I reflects a return to larger aircraft in order to carry servos and reed receivers made possible by the current rules. Basic plane designs aren't a problem but construction offers some rather rough challenges in meeting the standards of ruggedness achieved in planes like the Separator, a Texas product conceived by Ben Harr in 1955. Previously, construction of craft up to 48 inch span required relatively simple and light construction methods. However, the new trend means dealing with bigger dimensions and weights which spell higher impact loads. Power plant displacements are going up also. Where 15's and 19's were king, 35's have taken over—and it's safe to predict engine displacements of .45 and larger will be pre-

(Continued on page 63)

F.A.S.T.

First All Speed Team

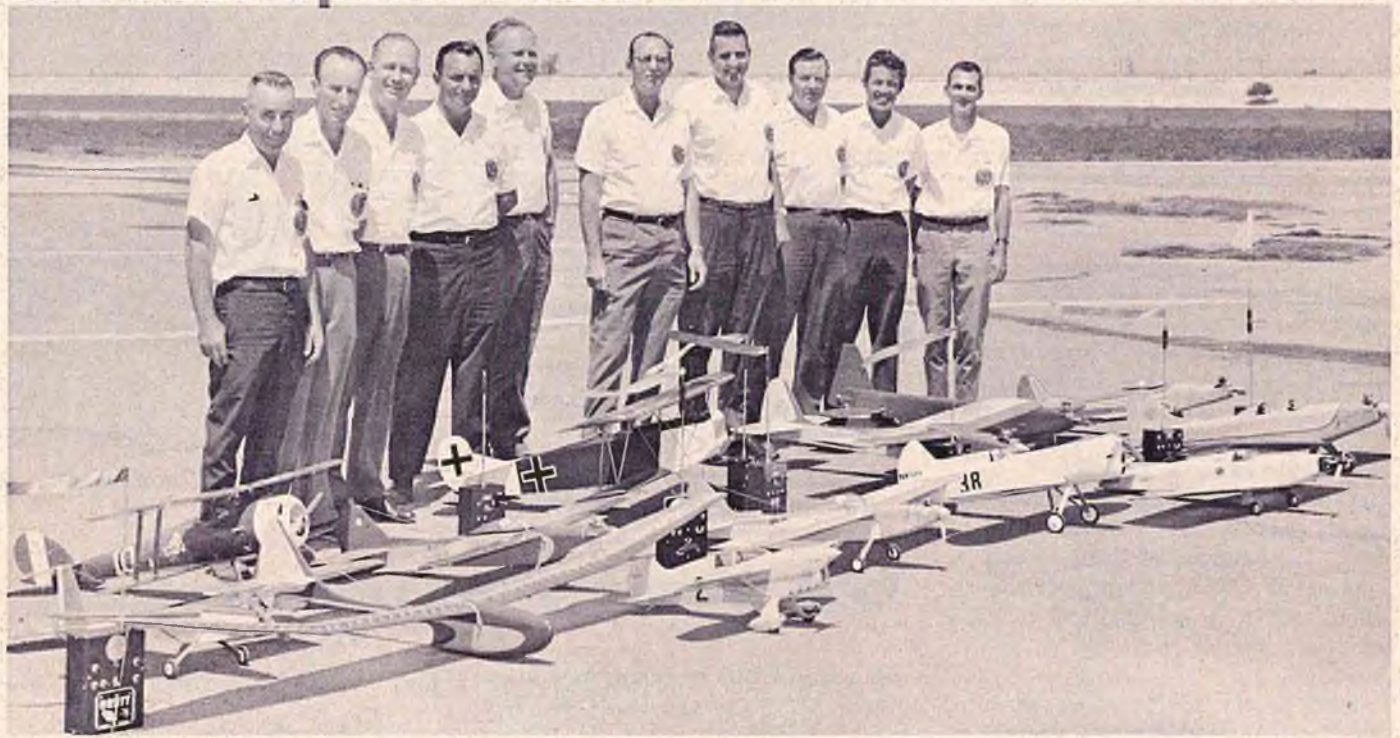

L to R: Larry Williams, Granger Williams, Les McBrayer, Bob Thomason, Bud Hartranft, Chuck Coryell, Danny Lutz, Howard Reed, Bill Williams, and Keith Storey. Not present, Jim Brant and Leighton Conrad. The FAST Club.

Located in Los Angeles, California, FAST is one of the world's most exclusive RC clubs. If you wanted to join FAST you would probably become discouraged, for it was conceived, and designed to stay, as a small, extremely close-knit, and very active group — receding hairlines, paunches, et al. They say they have a treasurer among them, but it is difficult to find out who he is. FAST members also claim twelve presidents, simply because there are twelve members.

If this introduction sounds like the description of an anti-social, secret organization, nothing could be further from the truth. Here is a group that represents a combined total of well over 300 years of building and flying models. As an example, FAST member Bud Hartranft built his first model circa 1925. Bud, along with his

fellow members, take their modeling quite seriously, and it is doubtful if a more friendly or helpful group can be found anywhere.

The FAST club was formed in 1946 as a control line speed team, called the First All Speed Team. Two years later, in 1948, Granger Williams flew a scale De Havilland 4 with radio to become the club's first RC flier. The club subsequently turned completely to radio control in 1959, with one exception — each year they contract to fly several daily demonstrations of control line models at the Southern California Hobby Show. The revenue from this one-time-a-year stint of ukie flying finances the FAST club for an entire year's activities. As a result, they have a comfortable financial picture without the necessity for an every member dues assessment.

Since the club was originally formed

by a group of speed merchants, it was only logical that speed should be injected into their RC activities. They held their first RC speed trials and pylon races in 1960. The original pylon race concept was submitted to the AMA by FAST as a proposal to race two or more semi-scale (proto) type models simultaneously around pylons in the classic fashion of the Thompson Trophy and Goodyear races. This proved to be a thrilling and spectator-pleasing event.

As with all organizations, FAST has had its share of disappointments. Only a few days before the 1963 Nationals at Los Alamitos, the planned RC event management was suddenly non-existent. The FAST club pitched in and did an excellent job of making the event possible. Their "thank you" came in the form of a highly critical report of the '63 Nat's in another

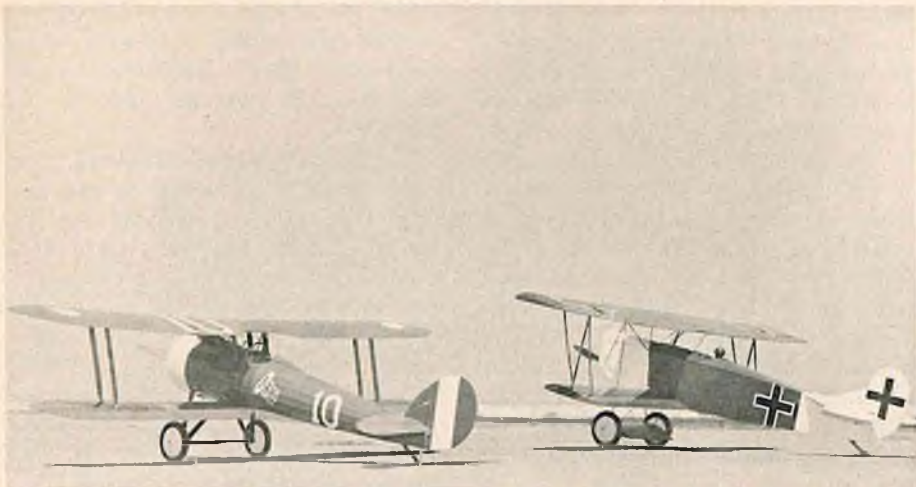

Examples of the outstanding scale designs that exemplify FAST club members. This group is known for scale ships that fly as well as they look!

model publication, written by an unhappy individual, and charging that the RC event was directed by a bunch of incompetent control line fliers. Such irresponsible words in print by an uninformed writer can hurt even the most seasoned model enthusiast.

FAST enjoys a distinction shared by very few other clubs. In their membership is a former President of the AMA, Keith Storey, who works diligently at promoting model aviation. Incidentally, all FAST members are long time AMA members, all hold FCC licenses, with the club as a whole having been a generous contributor to the current AMA/FCC Fund. FAST is also a charter member of the Southern California Council of Radio Control Clubs.

Earlier, a mention was made of Bud Hartranft. A visit to this modeler's workshop is a memorable experience for even a veteran RC'er. Airplanes, boats, and cars — all radio controlled — are everywhere apparent. On the shelves, in the rafters, and in the cabinets, are models and engines of every type and description. It is, to say the least, difficult to proceed with a coherent conversation as your train of thought is continuously interrupted by the visual discovery of another exciting model venture.

Granger and Larry Williams can merely open their shop doors and the scale enthusiast will think he's having a beautiful dream. Every nook and corner is occupied by a superb scale model, either completed or under construction. One example is a four-

engine Fokker transport with details such as the accurate construction of each of the thirty-odd passenger seats in the upholstered cabin. Their Curtis Racer, Nieuport 28, Howard Mike, and Howard Pete have all had their share of publicity.

FAST member Howard Reed practices what he preaches (June-July '64 RCM), and for perfection of construction and finish, is hard to beat. Howard is also among the country's most diligent and highly respected contest directors.

Yet another member, Bill Williams, has over a hundred trophies lining the shelves on each side of his fireplace. His well-known Dominator, 86 Proof, and Mambo have brought home the hardware.

A current FAST project, now in the advanced planning stages, concerns the construction of a scale Thompson Trophy racer by each member, the RC ships to be raced around pylons for demonstrations at larger model meets and full-size air shows. As an example, Bill Williams' project is a GEE BEE with a 12" diameter cowling!

An unpublicized but significant fact is that every one of us enjoying the building and flying of model airplanes has been affected by the FAST members participation in the development of equipment and the general advancement of the hobby over the many years since their formation. This, then, is the FAST club...

... long live a great bunch of guys!

IF YOU WANT TO KEEP UP WITH RADIO CONTROL . . .

LOOK FOR THE New GRID LEAKS

R. C. DATA SERVICE

Now At Your HOBBY DEALERS!



Eighth year of service to the dedicated R/C modeler — featuring the latest and most unique aspects of R/C — EXCLUSIVELY R/C!

IF YOU DO NOT SUBSCRIBE, YOU CAN NOW BE SURE OF OBTAINING THIS EXCLUSIVELY R/C MAGAZINE FROM YOUR HOBBY DEALER.

YOU CAN SUBSCRIBE NOW!

1 Yr. 6 BIG ISSUES \$2.00
2 Yrs. 12 BIG ISSUES \$3.50

GRID LEAKS—Box 301, Higginsville, Mo. 64037

- Enclosed find \$2.00 for 1 yr. subscription
 Enclosed find \$3.50 for 2 yr. subscription

Name _____

Address _____

City _____ Zone _____

State _____

OUTSIDE U.S.A., PLEASE ADD \$1.00

(Continued from page 32)

Various landing gear configurations have been tried with equally varying degrees of success. After looking at what had been accomplished to date my approach to the problem was to try to make improvements wherever necessary without excessive work. I do not like the idea of a pneumatic system so I decided on a motor gear train.

I used a Bonner motor with two reduction gears and a 6/32 lead screw. The unit gives $2\frac{1}{2}$ inches of travel in 10 seconds under the full load of retracting the gear. This arrangement would not be practical for a reed setup because it is entirely unreasonable to think of holding a switch for 10 seconds while the gear is coming up (or down). A simple change in the Bonner Digimite Servo Amplifier permits a flick of an auxiliary control lever on the transmitter to tell the gear to retract (or lower), and the pilot then forgets the problem and goes on flying the airplane. For landing, the pilot flicks the switch to the down position on the downwind leg, and by the time he turns final, the gear is down and locked. The change in the servo amplifier consists of substituting a fixed resistor divider for the feedback pot. The values of resistors in the divider are chosen to duplicate the feedback pot for the servo in center or neutral position. When the auxiliary control lever is any place above the center position, it is telling the servo to drive one direction, and when it is below center, it tells the motor to drive in the opposite direction. The motor drives in the direction specified until it opens one of the limit switches. These switches are adjustable and determine the limits of travel of the landing gear servo. It is probably desirable to design a simpler amplifier to do this job but the method chosen was the most expedient and works so well that I'm not inclined to change it.

The main gear is patterned after Dale Root's "Roottang" gear. (Reference **American Modeler**) This seemed to be the simplest to construct and is a very durable arrangement. The

disadvantages I see are: first, the gear goes forward when retracting, causing the servo to work against the airload as well as lifting the gear up into the wing. Although I have had no trouble in this regard, it seems undesirable to me. Second, the wheels are vertical when retracted, consequently it is impossible to completely hide them. To hide a $2\frac{1}{2}$ " diameter wheel, the wing must be at least $2\frac{3}{4}$ " thick. Conversely, the advantages are (1) the airload helps lower the gear which, after all, is the most important, (2) the mechanism is extremely durable with very definite locking qualities, and (3) the hardware is easy to construct.

The gross details are clear in Figure 4; however, if the reader is inclined to duplicate this type of landing gear, then I would suggest he read Dale Roots' article.

The nose gear design evolved after taking a long hard look at Pappy deBolts' retractable gear unit. Although the design is quite different, the pivot point alignment is similar. Figure 4 illustrates how this unit works and how it is connected to the wing mounted servo unit. One problem with a retractable nose gear is that the steering linkage must not in any way hinder the retracting process. Also the retracted nose wheel should not hinder rudder movement in the air. These two problems have been overcome by putting a coil spring in the push rod that goes from the rudder servo to the nose wheel and by making the actuator rod arm pivot point axial with the pivot line around which the nose gear is retracted.

My first project since returning from Dallas has been to move the flaps back to the trailing edge of the wing. I hoped this would reduce the tendency to nose up when the flaps are lowered. Some "experts" told me that I moved them in the wrong direction. I'm not sure this is true, but I am sure that moving them to their present location hasn't solved the problem. One thing I would rather not do is change the trim on the airplane every time the flaps are lowered. I also would discard any idea of a linkage to change the elevator position whenever the flaps are lowered.

After playing with this beast for $2\frac{1}{2}$ months, it seems appropriate that some evaluation of the new features

should be attempted even though my notions may differ somewhat from your own. After considerable omphaloskepsis, I sort of conclude as follows:

The mixture control is nonsense for the weekend flier, unless he gets his kicks from building and showing off special gadgets. For the contest flier it is another story. When a contestant waits all day for one or two flights, only to have them abort because the engine leans out or richens up, then the value of mixture control becomes apparent. This doesn't mean that every contest flier should rush out and add mixture control to his airplane. The factors that must be evaluated are weight, space, cost and how often a flight is lost due to bad mixture adjustment. Also on the negative side is the fact that a flight can abort because of a mixture control malfunction. It is my feeling that the cross-over point on weight is about 3 to 4 ounces. If it adds more than 4 ounces, leave it out. If it can be done for 3 or less, then put it in if (1) you've got the time and money; (2) you fly contest; (3) you have a place to put everything without grossly changing the aircraft structure or affecting its aerodynamic qualities.

The flaps and retractable landing gear are features that can be enjoyed by the sport flier, but under present contest patterns, I can't see where they will greatly change a contestants score. With the gear retracted the airplane is cleaner and does fly through maneuvers more smoothly, but there is an added weight factor here that offsets the advantages gained. If the rules are changed so that a contestant with retractable wheels has an advantage, then many contestants will go that way. Personally I like retractable gear and don't think I'll ever build another airplane without this feature. In fact I am now working on a new, better and lighter system for my next ship.

It is my opinion that the flaps (if the trim problem is resolved) will be desirable for both contest and sport flying. Spot landings will be considerably easier even to the point where a 25 foot circle might be considered.

And that's the story — the age of proportional control is here. You take it from this point on.

The Roostertail



The Official Publication of the International Model Power Boat Association
 General Office: 2405 19th Avenue Broadview, Ill. 60155

Ballots for the election of officers and for changes in the By-Laws, Constitution, and Rules of Competition have been sent to all members of the IMPBA. Consider each proposal carefully, mark the appropriate box to indicate your preference, then return the ballots to the General Office within ten days. All of the revisions to be voted upon were written to clarify or update the existing standards, and I urge the adoption of each of the measures which are presented on the ballots. The slate of officials is unopposed, although there was one other candidate nominated — Peter F. Yanzer declined nomination from the office of President of the IMPBA.

“Mister, when do the races start?”

This, from a gum chewing moppet while a gas boat was running on the oval course! The urge to give the kid a speech about the skills required to run anything by radio control was overcome by the realization that all too many people have the same idea about boat racing. In a race, the clock doesn't mean anything to anyone except the man who is running. As far as anyone else is concerned, a race must be run between two similar competitors. A turtle race can be exciting if there are two or more turtles involved, but can you imagine a turtle race run against the clock only? One turtle at a time, yet! Unless there is some other element involved, principally danger, one-at-a-time racing of anything has little interest! The human mind has a difficult time comparing things which take place at sep-

arate times.

Obviously, multiple boat racing is the answer to the problem of creating excitement. In this event, there is the thrill of racing, plus the element of danger of high speed collision! All this, and the contestant can still go home with a one-piece neck!

In mid-September, we had a “fun-run” at Phillips Park in Aurora, Illinois. Nobody even wanted to “lone wolf” it in the pond. There was no clock running, no judges, no official heats, yet every sorty turned out to be a race. You just naturally try to beat the other guy around the markers. With no time limit and no lap limit, these jaunts got mighty interesting. The crowd that was attracted was amazing! People simply like to watch a race. Now this is where the racing bug nips next year's contestants. Watch what happens to your club membership when you consistently run more than one boat at a time!

In order to allow a modeler to build any type of hull he pleases, use any size engine, hopped up or stock, and still have a chance to win a multi boat contest, it is imperative that a system of racing be developed which eliminates the inequities existing between contestants. Even if everyone did build the same boat (horrors) and used the same engine (good grief) there would still be the age old squawk about stock vs. modified. How would you go about equalizing all the factors of hull type, engine make, engine size, stock or hopped? I solicit your proposal.

Try this system the next time you

(Continued on page 46)

RADIO CONTROL MODELER

Circle No. 108 on Reader Service Page

ATTENTION . . .

Proportional Fliers

TAME THAT FLYING BOMB (AT NEUTRAL) WHILE HOLDING IN RESERVE ALL THE CONTROL YOU WANT.

USE SMOOTH NEUT.

A PROPORTIONAL SERVO ADAPTER FOR USE ON ELEVATOR & AILERON WHEEL OUTPUT TYPE SERVOS.

FEATURES

- Logarithmic output (slow start-fast finish)
- Electrical isolation
- Molded of delrin for max. strength & self-lubrication
- Use as much control movement as you want without critical neutral.

PRICE—\$2.50

Manufactured by
CRESCENT INDUSTRIES, INC.
 New Freedom, Pennsylvania

Circle No. 109 on Reader Service Page

It's What's Up Front That Counts!



KUSTOM 51 R/C

- MEEHANITE SLEEVES
- BUILT-IN CARBURETION
- 2200-11,000 RPM RANGE
- SINTERED IRON RINGS
- \$30 PLUS TAX AND POSTAGE

KUSTOM ENGINES

BOX 2347
 FULLERTON, CALIF.

JOHNSON RADIO CONTROL INTERNATIONAL

Fast delivery, direct from
 America, on all advertised
 R/C equipment.

Single • Multi • Reed
 Proportional
 by

ORBIT
BONNER
MIN-X
F & M
CITIZENSHIP
KRAFT
ACE
DIGICON
CONTROLAIRE

American Prices

Payment in England or America

Johnson Radio Control International
 Larkhill • Wiltshire • England

(Continued from page 34)

PA-9 Magnetic Proportional Actuator

The Babcock PA-9 proportional rudder actuator is a permanent magnet in a configuration similar to a two-pole electric motor, therefore extremely efficient for its size and weight, having two points of magnetic attraction and two points of magnetic repulsion. In operation, and when the transmitter control knob is at neutral, the magnetic actuator is pulsing across its entire range, causing the rudder to follow this left and right throw. Although the rudder is "wagging" from side to side, the aircraft is flying in a smooth and straight flight pattern. Turning the control knob either left or right, thereby varying the rate duty cycle, causes the PA-9 to pulse correspondingly more to the left or right, creating an identical deflection at the rudder surface. This, in turn, creates a smooth turn, proportional to the amount of command deflection.

For stunting, the full right or full left buttons are used, creating instantaneous full right or full left rudder.

The PA-9 actuator is identical in size and mounting requirements to the Mark VII escapement provided with the BC-21 system. Also mounted on the 1 3/4" square actuator board is a clever circuit arrangement to complete the off-cycle side of the magnetic actuator. Connection of the PA-9 arm to the rudder surface is by a conventional wire and balsa torque rod.

Findings

Tuning of the Babcock BC-22 system is accomplished by simply removing the antenna from the BCT-22 transmitter, then tuning the receiver slug until you have achieved the maximum range (ten feet or more) at which the rudder will continue pulsing. No long distance range check is necessary, although it is recommended as a final safety check.

Flight testing was conducted with the D.Q.A. 704 model powered by a Cox Pee Wee .020, and carried out by RCM's editor and staff member Bill O'Brien. All flight performance was

smooth, and at no time did the "22" system malfunction or run out of range. Air range was, again, out of sight.

Following the testing of this system, we find that it equals or exceeds the BC-21 system in all respects, and meets the manufacturer's specifications to the letter. This is, in our opinion, an extremely effective introduction to simple proportional control, and an ideal system for the beginner and sport flyer. We particularly commend the pre-wiring of the airborne system, leaving only three wires to connect to three corresponding lugs on the PA-9 actuator. The ability of the BCR-22 receiver to reject spurious emissions and adjacent interference is particularly commendable for metropolitan areas of interference.

As a conclusion, we can only reiterate what we stated about the BC-21—when the performance and price of this system are considered, it becomes an exceptional buy—a well-engineered system of compatible units designed to offer maximum performance and reliability with a minimum expenditure.

(Continued from page 12)

installations is usually a little less, simply because one less servo is required (no elevator trim).

Reliability should be nearly as good as reeds, but not quite. These systems are more complex and have many more parts to potentially fail than do reeds.

Ability to function over wide temperatures should be every bit as good as reeds and perhaps better. Most sets should function from freezing to 140 degrees with little change in characteristics.

The cost of proportional sets will be quite high for some time. Analog sets will tend to cost less than digital. The price tag startles one upon first glance but if time is taken to add up equivalent equipment to operate a reed set, the difference is not as great as was assumed at first glance. The prospective buyer is just not conditioned to see the cost of servos, battery packs, plugs, etc., all in one lump package.

We seem to have turned the corner on the age of proportional control, and I for one have joined the rush to my friendly hobby dealer.

(Continued from page 45)

ference on the course. The faster boat must overtake the slower boat and pass to win. Since engines and boats vary from day to day, it is wise to have the time trial figures used for one day only.

For example: Boat "A" completes one lap in 40 seconds. Boat "B" completes one lap in 30 seconds. $40 - 30 = 10$ seconds. $10 \times .8 = 8$ second handicap factor. If you decide you want to race for 5 laps, the 8 seconds times 5 laps = 40 second handicap. Boat "A" (the slower boat) is released 40 seconds ahead of the boat "B". In formula: $A - B \times .8 = \text{handicap}$.

This system eliminates all factors of difference between any two boats. It can be used for any number of craft by simply using the same formula and releasing the slowest boat first, then the next slower, etc. Only the speed of the boat TODAY is taken into consideration. No other factors are involved. Any boat can race any boat. Build the kind you like and stay in the win. What could be simpler?

Give this system some thought—I have the feeling that it will be a part of the rules of competition before very long.

A very important event that should be marked on your calendar in January is a Seminar on R/C Flying and R/C Boating.

Registration can be accomplished at the Seminar or a \$1.00 fee can be sent to Mearle T. Hickman, 8101 Monte Vista, Kalamazoo, Michigan 49002.

Speakers of interest will be Ed Kazmirski, Mearle T. Hickman, Tom Brett and Mert Mischnick. Also, a professional pilot will speak.

Mark well this date of January 16, 1965, at the Holiday Inn in Kalamazoo, Michigan. The time will be from 8:45 AM in the morning, starting with the registration, then a morning session, break for lunch at 11:45 AM, (arrangement with Holiday Inn for an excellent \$2.00 Buffet Lunch) and an afternoon session ending at approximately 4:00 PM. All persons interested in R/C flying or boating are invited.

(Continued from page 35)

while a rearward movement (up elevator) causes a decrease in pulse rate.

A rate trim lever is provided to adjust the pulse width ratio for rudder trim function. A tone-off pushbutton permits transmission of an unmodulated carrier which will give full left rudder (and up elevator with galloping ghost) and/or low speed engine control. A tone-on pushbutton provides a solid tone signal to be transmitted which will give full right rudder (and up elevator with galloping ghost), and/or high speed engine control.

Pulsmite 1200S Model TCPT-1

Test Data

Voltage: 9 volts (Burgess D-6, Eveready #276, or RCA VS-306).

Currents: 65 Ma average.

Pulse Data: Pulse rate range including extremes of trim, 2 to 20 pps. Pulse width range, including extremes of trim, 20/80 to 80/20.

Tone Frequency: 1200 cycles per second.

Modulation Percentage: 85 to 90%.

RF Amplifier Input Power: 350 MW.

Operating Temperature Range: Temperature stabilized from 20 to 140 deg. F.

Pulsmite 1200S Model TCPT-1 Physical Data

Size: 6½" x 5" x 2½".

Weight: 32 ounces with battery.

Printed Circuit Board: 1/16" glass epoxy with 2 ounce tin plated copper.

Antenna: Centerloaded, 24" extended, 12" collapsed. Six section telescoping.

Case: Gold anodized aluminum with silk screened Min-X registered trademark.

Controls: Single stick and yoke assembly for rate and width control plus trim levers for each. Two pushbutton switches for full on and full off tone switching. Slide switch for battery supply switching.

Manufacturer: Min-X Radio, Inc., 8714 Grand River Avenue, Detroit, Michigan 48204.

Price and Availability: \$59.95 plus tax. Currently available.

Min-X Superhet 1200S Model SHS-1 Receiver

The Min-X Model SHS-1 receiver was designed to operate as a companion unit to the Pulsmite 1200S proportional transmitter, and incorporates an audio frequency selective filter coupled with a fixed threshold level to reduce CB and electrical noise interference. This filter requires a transmitted frequency stable audio tone of 1200 cycles per second. Voltage required is 3 to 3.75 volts. Compatible actuators include any good 3-volt escapement, magnetic actuator, or Mighty-Midget type galloping ghost servomechanism. Audio selectivity, shot noise, and electrical noise rejection was excellent.

Superhet 1200S Model SHS-1 Receiver Test Data

Voltage: 3 to 3.75 volts (2 alkaline energizer pencils or 3 nickel cadmium cells).

Currents:

Idle: 4 to 6 Ma.

Signal On: 30 to 35 Ma.

Tone Frequency: 1200 cycles per second, plus or minus 20 cps transmitter stability.

Modulation Percentage Required: 60 to 100%.

Operating Temperature Range: 20 to 140 degrees F.

Selectivity: 5 Kc.

Sensitivity: 15 microvolts.

Relay: SPDT Deans with arc suppressed output.

Interference: With carrier on, the receiver was immune to adjacent channel interference with the exception that some erratic modulation could be introduced when another transmitter was keyed within six feet of the Pulsmite 1200S.

Combined Range Check: Antenna removed, 22 feet range. Antenna in place and fully extended, consistently in excess of 5000 feet.

Superhet 1200S Model SHS-1 Receiver Physical Data

Size: 1" x 1 7/8" x 2 7/8".

Weight: 3½ ounces.

Case: Gold anodized aluminum with silk-screened Min-X registered trademark.

Antenna: 36" of #26 19-strand wire.

Complementary Equipment: Furnished with antenna specified, Deans SPDT relay, factory wired connector plug and matching socket.

Manufacturer: Min-X Radio, Inc., 8714 Grand River Ave., Detroit, Michigan 48204.

Price and Availability: \$49.95. Currently available.

Findings

In addition to the excellent merchandising, electronic, and mechanical design considerations of the Pulsmite 1200S transmitter and matching SHS-1 superhet receiver, the electronic pulser incorporated in the 1200S is the finest we have seen for single channel pulse proportional operation. In conjunction with the Go-Ac actuator, for galloping ghost operation, the pulser provided completely reliable operation at all control positions. There was some noticeable interaction at the full extremes of the left and down positions, causing the Go-Ac to "go-around" and subsequently trigger the motor control arm. This interaction, however, is far less than that presented by any other pulser we have tested, and such extreme control functions would not normally be used in galloping ghost or simple-simul operation.

The installation as photographed worked immediately upon connection, and as specified in the manufacturer's specification sheets. The use of the Go-Ac actuator plus the S.E.P. galloping ghost coupler kit for connecting tail yoke linkages would provide the pulse proportional fan with the highest degree of reliability obtainable to date with this form of radio control operation. This, in fact, takes most of the tinkering out of what was once known as a tinkerer's sport — galloping ghost.

Min-X engineers are to be congratulated on the design of both of these units. They are highly recommended to the consideration of all pulse proportional modelers.

NEW VECO R/C & RACING GLOW PLUGS



Here is a new design in glass-to-metal, hermetically sealed glow plugs for multi-speed R/C and racing. The efficient, heavy-duty platinum alloy element provides for extra long life and will take 2-volts. Used with VECO POWER FUEL 1, these plugs will deliver top power and excellent idle.
108 R/C .95 109 Racing .95

SEND FOR FREE BOOKLET BY CLARENCE LEE "Tips For Obtaining Reliable Idle and Maximum Performance From Veco Engines" Include 10¢ if you wish a 1964 Veco Catalog.

VECO PRODUCTS

P.O. Box 229, Burbank, Calif.
MP64427 ~

Circle No. 110 on Reader Service Page

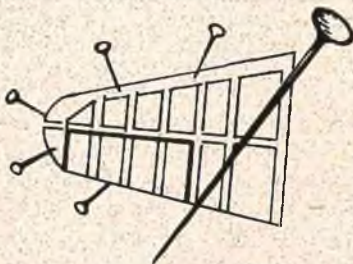

specially priced!

Full Year's Supply

MODEL AIRPLANE

PINS

\$1.99
pkg. of
over
2000

OVER 4200 PINS ONLY \$3.44

- Steel shank
- No wood split
- New smooth top easy to push
- Specially honed
- Rust and tarnish proof

Send check cash or money order
Postage C.O.D.

National Distributing Co.

4125 Reisterstown Rd. Baltimore 15, Md.

Circle No. 111 on Reader Service Page

KEN WILLARD

(Continued from page 14)

the transmitter sent out a "carrier wave." The receiver, although turned on, was not receiving anything, and the old gas tube would be hissing and crackling merrily away until the transmitter emitted a carrier wave. This "quieted" the receiver, and in doing so it also let current pass to the relay, thus providing a control source.

The carrier system worked fine — so long as nobody nearby turned on another carrier! And that was the problem, because other transmitters in the citizens band had to have the carrier on before voice — or tone — could be transmitted.

So Walt Good, with his WAG 3 tuber, and then Babcock, with the 3 tube BCR-3, set the pace for tone transmission, and reliability went up. So did the weight.

Then Vic Nelson, of Deltron, experimented and came out with a little 22½ volt tone receiver using transistors. It was small, lightweight, and operated well — so long as you watched the temperature. You could go out in the morning, tune up and fly, but as the air warmed up, if you didn't check the tuning, first thing you know you'd lose range. Sometimes, you even had to tune between flights! But it was a long step in the right direction.

A lot of other development came along — combinations of tubes and transistors — and then Frank Hoover came out with the forerunner of today's popular 3 volt all transistorized tone receiver. It worked fine, but had a couple of bugs that could cause a lot of trouble, if you didn't know about them. For one thing, it was temperature sensitive, not so much in tuning as in the rate of response. If the temperature dropped below the normal 60-75 range, the receiver would lag behind the transmitter signal. You'd push the button once, and after noticeable lag — perhaps ¼ to ½ second, the receiver would respond. And if you pressed the transmitter button twice, but without waiting for the receiver to pick up the first signal, you'd only get one response! Boy, did that get confusing! But we learned to live with it although it didn't take long for Frank to improve his circuit and overcome the problem.

Then there was the swamping — the triggering of the receiver when the transmitter antenna is too close. If you have a receiver that swamps, it's not bad — it's just a nuisance. There are ways to get around it; the simplest is to have a friend launch your model while you remain some distance away with the transmitter. The other way is to launch your model with receiver on and transmitter off (not the other way around!) then turn your transmitter on after the model is too far away to swamp. This technique is only good if you know your model will free flight until you get the transmitter on. Even then there are drawbacks. Many a model has been saved from a crackup due to a



The Babcock BCR-3 — one of the most reliable of early day receivers. Heavy and large by today's standards.

bad launch because the pilot made a fast correction. And I've seen crackups at the end of an otherwise perfect flight because the pilot forgot about swamping, brought the model in too close, and the receiver locked in. Seen it? Heck, I might as well admit it — I've done it!

Swamping can even go so far with some receivers as to cause them to stop working until you turn them off and then back on again. I've seen fly aways where the pilot checked the operation of his controls just prior to launch, then heaved the model into the air without realizing that the receiver had swamped out on the last checkout signal and wouldn't take another signal. By that time, of course, it was too late to turn the receiver off and back on.

So check your 3 volt receivers for their swamping characteristics — unless you have one of C&S's units with the "sensimatic" circuitry which prevents swamping.

Another pitfall — and this isn't limited to the 3 volt receivers — is the Bad Connection. Hooking up these little receivers is so simple that it can lead to carelessness. If the connections to the escapement are poor, due to a high resistance or "cold" solder joint, the voltage at the escapement can be too low even though the batteries are fresh. A voltmeter is a must in order to find bad connections. They can occur anywhere — in battery boxes, switches, or escapement connections. In fact, it's not a bad idea, if you do find a bad solder joint, to resolder all connections as an added precaution.

Enough has been said about interference to preclude any lengthy dis-

cussion of it here. You've all suffered from it. The newer superhet receivers have gone a long way towards reducing interference, although not entirely eliminating it. And the recent FCC actions had one significant statement, that wider band separation isn't feasible, therefore modelers either must live with and accept interference as a way of life — or improve the selectivity of their equipment. In that regard, the new development by Babcock Controls looks very promising. With a tone frequency way above the normally used range (6000 cycles compared to 400-1000) it takes careful tuning to get maximum range, but it pays off, because the Babcock system, for all practical purposes, is interference free. This method of avoiding interference can also be used, so I understand, with more sophisticated equipment than the little 9 volt BC-21 system. If so, it will be another significant milestone in the development of radio control hobby equipment.

So over the years, various manufacturers have enjoyed periods of leadership. But each improvement came complete with some shortcoming, which some other manufacturer improved on, and then it was his turn to lead the field for a while.

But there is one thing which is universal with them all, and that is that when they go into production, some of the units coming off the line have bad components. No matter how hard they try, the manufacturers haven't been able to produce 100% perfect units. This is probably one of the

(Continued on page 64)

The C & S 505 double ended receiver — an example of present day 3-volt relayless design. Progress, along with miniaturization!

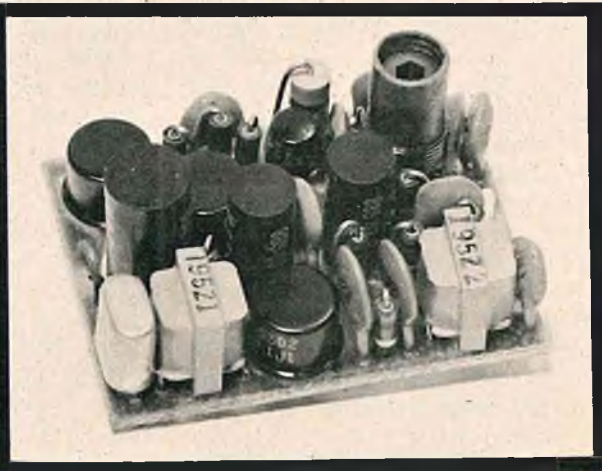

RC MARKET PLACE

COMMERCIAL RATE: For firms or individuals offering commercial products or services, 35 cents per word (including name and address). Minimum order \$3.50. Photographs not accepted. Payment must accompany copy except when ads are placed by accredited advertising agencies. Frequency discount: 5% for 6 months; 10% for 12 months paid in advance.

READER RATE: For individuals with personal items to buy, sell, or trade, 20 cents per word (including name and address). No minimum.

SAMPEY 404 Transmitter, Receiver, Servos, Power Packs, Chargers, Harness, Pre-Programmed Motor Control, \$350. Digicon quad proportional transmitter, receiver, eight servos, power packs, \$350. Both units guaranteed. Capt. D. Huff, 510 Melton Apt 11, Cheyenne, Wyoming.

(2-a)

DIGICON Proportional. Perfect flying condition. Includes all power packs, chargers, Steeb feedback servos. \$325. Dr. Robert Lien, 1010 Nashville, New Orleans, Louisiana.

LW Champ's, two, brand new, ready to fly. \$85. Daniel Reiss, 604 W. Evergreen St., Apt. 9, Inglewood, California 90302.

SELECTED assortment of built-up RC aircraft. Trade in your old motor, or RC equipment for new and in-stock RC gear. Our trade-in beats them all. Citizen-Ship 10 ch. superhet receiver & transmitter \$138.88. Everything for every RC modeler. Send 10c for Special Bargain Bulletin. Nashville Hobby Center, 903 Church Street, Nashville, Tennessee.

P-47N SCALE PLANS, full multi-stunt, 63" span, 700 sq. in. detailed. Photo Feb. M-A-N. \$4.50. Schellenbaum, 6109 Ponderosa N.E., Albuquerque, New Mexico.

UP TO 50% trade-in allowance on used radio control units for a new single or multi channel unit in most popular makes. Send 70¢ for a complete 120 page catalog listing all types of planes, radio units, and accessories (refundable with first order). Listing of used equipment sent free upon request. Phil-Nick Hobby Supply, P.O. Box 84, Oaks Corners, New York.

FASTEST GROWING HOBBY CENTER

IN NEW YORK CITY

WE WILL NOT BE UNDERSOLD!

\$\$\$\$\$\$ SAVE \$\$\$\$\$\$

OUR EXPANSION HAS ALLOWED US TO BRING YOU THE LOWEST PRICES ON ALL LEADING R/C EQUIPMENT, INCLUDING MULTI—ALL IN STOCK, ALL BRAND NEW — OR TELL US YOUR NEED AND RECEIVE OUR LOW QUOTATION —

\$\$\$\$\$\$ SAVE \$\$\$\$\$\$

DON'T WAIT!

TRADE IN YOUR BEAT UP ENGINE, OR R/C EQUIPMENT FOR NEW, UP TO DATE, RELIABLE EQUIPMENT.

**YOU CAN SAVE 30%
SEE US BEFORE YOU
BUY—CHECK OUR PRICES!**

OUR TWELFTH YEAR OF SERVICE

BROWN'S HOBBY CENTER

6031 BROADWAY, BX. 71, N.Y.

One Block North of 242nd St., "E" Station
OPPOSITE VAN CORTLANDT MANSION

KI 8-5422

ALL BRANDS OF MERCHANDISE IN STOCK

D.Q.A. 704

(Continued from page 22)

time, stretching your silk chordwise across the wing as you go to remove wrinkles. Repeat for the entire length of the panel, finally securing the end of the silk to the tip. Re-dope any areas where wrinkles occur and pull silk taut. While one panel is drying, repeat this process with the opposite panel. Then, return to the first panel you covered and trim off the excess silk overhang with a double edged razor. Dope down any protruding edges, rubbing them smooth with your finger. Now proceed to cover the reverse side of each panel. When thoroughly dry, mix a quantity of fifty percent clear butyrate dope and fifty percent dope thinner and add a few drops of warp resistor or plasticizer to prevent warpage. Brush on several coats of this thinned dope mixture, brushing chordwise, and making sure there is not so much dope on your brush as to seep through the silk and run on the inside surface. Allow each coat to dry, then repeat until all of the pores of the silk are filled and no bubbles appear in the individual pores when the dope is applied. Two types of covering material requiring the least amount of dope to fill the weave, and thus less weight, is Esaki silk, and the newly imported colored silk distributed by Royal Products Company of Denver, Colorado.

Now set the wing aside for two or three days so that the dope will "cure" — that is, to allow all of the thinners to reach the surface and evaporate.

Fuselage: Begin fuselage construction by cutting out two fuselage sides, exactly as shown on plans, from 1/16" hard balsa. Be sure that the wing and stab platform areas are **exactly** as shown. To change these angles of incidence will drastically affect the flight trim of the D.Q.A. Cut out two fuselage doublers from 1/16" sheet, the grain running lengthwise. Glue doublers to fuselage sides and allow to dry. Cut out firewall F-1 from 1/8" plywood; two formers F-2 from 1/16" balsa, the grain of each F-2 running opposite to the other, then glue both F-2's together; cut one F-3 from 1/16" plywood; one F-4 from 1/16"

balsa; and one tail former F-5 from 1/16" plywood. Cut one fuselage bottom 5 1/2" x 2 1/4" from 1/16" plywood. Check to make sure this is perfectly square as it is used to align the fuselage sides.

Mark off the locations of the formers on the fuselage sides. Add the 1/8" x 1/8" longerons to the top and bottom of each fuselage side piece. Add the 1/8" square actuator slide supports to each side, followed by the 1/8" x 1" tripler pieces to each side of the nose. When dry, lay one fuselage side down and glue former F-2 and F-4 in place. Before they are dry, cement the 1/16" ply fuselage bottom to the side and to F-2 and F-4. When square, this will align your fuselage sides. Add the other side piece. When thoroughly dry, add the firewall, cementing in place with white glue and holding in place with masking tape until dry. Glue the 1/4" square tail piece in place and add the 1/16" ply tail former, holding this assembly in place with tape until dry.

Now take some 1/16" sheeting, grain crosswise to the fuselage length, and plank the top rear of the fuselage from the trailing edge of the wing to the stab platform, and on the bottom from F-5 to F-4 where the plywood base commences. Add the 1/16" ply bottom planking to the nose section, forming the bend and holding again with masking tape until dry. Use a good grade of white glue wherever a plywood-balsa joint is required. Add the 1/4" square crossbrace in front of Former F-2.

Next, take your Cox Pee Wee .020 and carefully remove the four back bolts from the fuel tank. Be sure not to drop the thin fiber gasket between the tank and crankcase of the engine. Carefully turn the engine itself until the cylinder points sideways, without moving the tank and needle valve assembly. Now reinstall the four tank bolts and secure in place, tightening carefully so as not to strip the threads. Locate the engine in the center of the firewall, making sure the top of the needle valve clears the top of the fuselage, then drill four 7/64" holes in firewall F-1. Install four 2-56 Du-Bro or Perfect blind mounting nuts in these holes in the rear of the firewall. Do not mount the engine at this time, but insert each of the 2-56 bolts and tighten down in order to secure the blind mounting nuts to F-1. Remove the bolts and put the engine away for the time being.

Cut a 1/4" x 2 1/4" strip of 1/32" plywood and secure to the top of F-1 for the hatch hold down. Cut a piece of 1/32" plywood to size shown for the hatch itself.

Cut the stabilizer from fairly hard 3/32" sheet balsa, butt-joining two sheets if necessary. Cut the tips from 3/32" x 1/2" stock to act as stiffeners. Add the 1/8" x 1/4" stiffeners to the underside of the stab. Locate the stabilizer on the fuselage and check to see if it sits level. When this is assured, glue in place.

When completed, cut the fin, rudder, and dorsal fin from 1/16" sheet, following the grain pattern indicated on the plans. Glue in place on the fuselage, making absolutely sure the fin and dorsal are straight up and down and centered on the fuselage. Add the rudder with four pieces of Top Flite hinge or pinking tape, or with nylon thread and figure-8 stitches, making sure that they are absolutely free of any binding or stiffness whatsoever!

Now, the entire fuselage may be sanded with 320 wet-or-dry paper. Cut three small strips of Top Flite hinge tape and glue around both corners of the firewall and fuselage sides and between the firewall and ply bottom. This will greatly reinforce the firewall in case of rough landings. Now brush on four or five coats of the 50/50 dope-thinner mix. Sand lightly after the second coat and again just prior to the last coat. When you dope the stabilizer, be sure to dope both top and bottom as quickly as possible to prevent warping. A small amount of color trim may be applied to the wing and fuselage, but don't overdo it! Color dope adds weight rapidly to these small ships!

When thoroughly dry, cut the 1/8" wing and landing gear hold-down dowels to length. Drill 1/8" holes where shown on the fuselage side view and install the dowels, gluing on the inside of the fuselage with white glue. Form the main gear and nose gear from 1/16" music wire as shown. Add two small wood screws on each side of the fuselage, located in the center of the 1/4" square crosspieces in front of F-2. The hatch slides into place under the ply strip on top of F-1 and is held in place with a rubber band stretched over the top of the hatch and secured to each wood screw.

(Continued on page 52)

(Continued from page 50)

A small bubble canopy of about 4" or 5" length may be purchased and glued in place in the wing center section if desired. Pactra C-77 glue is the best adhesive for securing the canopy to the wing. If a canopy is used, it will be necessary to stretch your wing hold-down rubber bands straight back from leading edge to trailing edge dowel, rather than criss-cross as in the more conventional manner.

The overall weight of the 704 should not exceed eleven ounces complete with radio equipment installed.

Equipment Installation

Both the Mark VII 9-volt escapement furnished with the Babcock BC-21 system and the PA-9 magnetic proportional rudder actuator furnished with the BC-22 system have identical mountings. Following the manufacturers instructions exactly, cut F-3 to accept the desired actuator, then install with four 2-56 nuts and bolts. Slide F-3, with actuator in place, between the slide rails in the fuselage sides. If you are using the Mark VII escapement, cut a length of .045 music wire to size and install, soldering the escapement arm to one end of the wire. The opposite end is bent up at a right angle parallel with the rudder. A small yoke of thin music wire is fashioned and installed on the rudder with a single 2-56 nut and bolt and two 2-56 washers. This yoke can be moved up or down to alter the amount of rudder throw desired. Be sure to solder a small brass washer or ferrule to the torque rod wire in front of F-3 and on the outside of F-5 to make sure that there is no more than 1/16" play back and forth on the torque rod. If you are using the BC-22 proportional system and the PA-9 actuator, install the wire rod and balsa torque rod exactly as instructed on the manufacturers spec sheet.

Check again to be sure that there is no binding in the hinges, and that the rudder yoke has enough clearance to prevent any binding against the rudder torque rod. Too, check the torque rod to make sure there is a small amount of play back and forth with no binding against the formers. This is absolutely essential for reliable performance.

Install the receiver by gluing it to a piece of sponge rubber the size of the base of the receiver. Glue this foam rubber with receiver in place to the floor of the fuselage aft of former F-2. Connect the two wires from the BC-21 to the two lugs on the Mark VII, or the three wires from the BC-22 to the three lugs on PA-9, per the manufacturers instructions. With the escapement system, mount the switch and test panel in place on the side of the fuselage, gluing the fibreboard base to the inside of the fuselage, the switch protruding from a 1/4" x 1/2" hole in the fuselage side. Run the battery leads through Former F-2, install a 9 volt transistor battery, wrap completely in foam, and install in the compartment area behind the firewall. Make sure all of your wiring is cabled, or twisted together in a neat bundle, then spot glue along the fuselage sides to hold in place out of the way of the actuator.

For the antenna, do not use the vertical music wire whip recommended by the manufacturer. The drag of this antenna is too great for the small size of the D.Q.A., and will cause a scalloping, or swooping, tendency in flight. Two other methods may be used — a straight piece of hook-up wire 18" long running out the bottom of the fuselage and spot glued along its length, with the remaining portion of the antenna allowed to trail out behind, or a piece of 16" hook-up wire glued along the length of the trailing edge of the wing and connected to the antenna at the receiver with a snug, one-pin connector.

Install your engine with the four 2-56 blind mounting nuts and add a Cox .020 Hi-Thrust prop. Add the main landing gear and secure in place by running a small rubber band through each leg of the gear and over the dowel several times.

Following the manufacturers instructions for the BC-21 system, remove the antenna from your Babcock transmitter, and add the small bulb furnished across the two prongs on the test panel installed in the fuselage. Do not turn the receiver switch on. Insert a nylon tuning wand in the receiver slug and tune for maximum brilliance. Then, tune the tone frequency adjustment on the transmitter for maximum brilliance. Add one section of antenna and one loading coil and repeat this process. Finally, in-

stall the complete antenna and tune for maximum brilliance and adjust the transmitter tone for maximum brightness on the bulb. When this is accomplished, you will have more range than you will ever need. Remove the bulb and turn off your transmitter. For the BC-22 the process is the same except that no bulb is used. Just watch the rudder actuator while tuning with the same procedure as above.

Flying

Be sure the D.Q.A. balances exactly where shown on the plans. Shift the battery or add weight as necessary to achieve the proper C.G.

Select a calm day and take the D.Q.A. to a schoolyard or grassy area for the first glide tests. Gently launch into the wind — you should have a steady glide forward followed by a three-point landing with no tendency to balloon out, stall, or nose down. If your C.G. is correct and the model noses down, add a small (1/32") shim under the leading edge of the wing. Repeat as necessary until the nosing-in tendency is corrected. If, on the other hand, your D.Q.A. tries to scallop or stall in the glide, add the same amount of shim under the trailing edge of the wing until corrected. Correct any tendency to turn left or right in the glide by bending the torque rod at the rudder until the glide is straight.

When test gliding with the BC-22 proportional system the transmitter and receiver must be turned on and the rudder set at neutral.

For the first power flights, select a calm day. Fill the Pee Wee tank with Cox Blue Can fuel. Start the engine, adjust the needle valve, and allow about thirty seconds to elapse. Now gently chuck the D.Q.A. forward, nose **slightly** downward, into the wind. Allow the model to gain about a hundred feet of altitude before applying a command. (You did turn on the receiver, didn't you?) The model should bore on straight ahead with a slight amount of climb. Notice any tendency to turn left or right. If the glide is straight and it turns left under power, add a washer under each motor mounting bolt on the left side. If the model has a tendency to turn sharply right, reduce the amount of right

(Continued on page 61)

SHOWCASE '64

Orbit 3-Channel Proportional—Scheduled for production shortly after the 1st of the year, the Orbit 3-channel proportional prototypes have been thoroughly field tested and appear to work to perfection. This new system features exactly the same circuitry as the Orbit quad proportional except that the symmetry function has been omitted. Transmitter measures approximately 6" x 5" x 2" and uses a standard 9-volt lantern battery. Single stick control with a motor-control lever and two trim knobs. Superhet receiver, much smaller than quad version. A micro switch can be used on the motor servo to give coupled aileron-rudder at all speeds less than full throttle. When at full throttle the rudder is inoperative and only the ailerons are used. Although price has not definitely been established, it is understood that the transmitter and receiver complete with harness, switch, and connectors will only be about \$200. Servos will be somewhere around \$30 each. Thus a complete 3-channel proportional system will cost approximately \$290, or \$320 if the extra switching servo is also used. **Circle #1 on the Reader Service Card.**

Proportional Yoke Assembly—John W. Lemon, Jr., Chief Engineer for Min-X Radio, Inc., announced that the unique yoke assembly used on the Pulsmite 1200 single channel proportional system will be available as a separate kit item in late December or early January. This kit will be complete with yoke system, pot mounting brackets (less pots), trim levers, control stick, trim gears, base mount, universal, centering spring, red plastic knobs, and complete installation instructions for do-it-yourself pulse proportional fliers. For further information, **Circle #2 on the Reader Service Card.**

Compatible Systems from Konac—Due to the fact that the R/C hobby is attracting hundreds of new enthusiasts each month, including a large percentage of newcomers to model aviation, Konac Systems has established a unique mail order service for the R/C industry. In order to assure the prospective RC'er the greatest possible opportunity for success, Konac is offering complete radio control systems, comprised of tested and proven compatible items, packaged as a complete unit and available at a systems price quite often substantially less than the price of the individual items when purchased separately. From an economy single channel system through full-house, each system can be purchased as a "basic" or "deluxe" unit — that is to say, it will contain either all of the items necessary for the beginner, or it will be just the basic radio items for the more experienced flier who would prefer to choose his own plane and engine. Complete systems are also available as a

(Continued on page 56)

HNE MEANS QUALITY

FEATURES

- Hand picked wood
 - One piece fuselage sides
 - Formed trike gear (Designed for strength and perfect take offs and landings.)
 - Easy to build
 - Parts cut out not die cut
 - Designed to fly (For beginner or expert)
 - Single to 6 channels
 - Power .09 to .19 (.09 for single channel)
 - Hardware included
 - Model can be assembled in 10 hours
 - Construction strength without unnecessary weight
- Words are not enough to describe this kit. Build it, fly it, see for yourself.
- Won 3 out of 4 contests this season.

The **CONTENDER**



Wing span 44"
Area 370 sq. in.
Weight 37 oz.

Power
.09 to
.19

\$14.95
Send check or Money order
No C.O.D.'s

DEALER INQUIRIES INVITED

130 N. MAGNOLIA ST.

HENRY NELSON ENTERPRISES

PEARL RIVER, N. Y.

Circle No. 116 on Reader Service Page

**new! COMPLETELY FINISHED AND
READY TO FLY...**

1. High impact flexible polyethylene
2. Will attach to any conventional landing gear (de-Bolt or wire type)
3. Operates equally well off water, sand or snow
4. Strong and durable, will not puncture on ground landings
5. Can be attached and removed in less than 3 minutes
6. Mounting bolts, spreader bars and wire included
7. Lightweight
8. Finished in aluminum color
(At present available in two sizes)



DEALER
INQUIRIES
INVITED

19 1/2" FOR .02 to .074 **\$5.95**
MAX. MODEL WT. 28 ozs.
WT. PER FLOAT 1 3/4 ozs.
28" FOR .09 to .29 **\$8.95**
MAX. MODEL WT. 72 ozs.
WT. PER FLOAT 3 1/4 ozs.

The GEE BEE Line / Box 347/Forest Park Sta./Springfield, Mass.

Circle No. 117 on Reader Service Page

**BUY THAT NEW
PROPORTIONAL
OR REED EQUIPMENT
with your...**

BANKAMERICARD

The Family Credit Card

John J. Nelson Jr.

AUTHORIZED SIGNATURES

J J NELSON JR
12/64
160 350 419 BA

Wilshire Model Center • 1326 Wilshire Blvd. • Santa Monica, Calif.

Circle No. 118 on Reader Service Page

EXCLUSIVELY EXPORT ...

EXCLUSIVELY R/C!



EXPORTATIONS export specialists

5061 Alhambra Ave., Los Angeles 32, Calif., U.S.A. ■ CA 1-6968 ■ Cable "EXTRONIC"

WE DON'T SELL OUR SERVICE . . .

We give it away

Whether you need a quadruple simultaneous proportional outfit, a single channel rig, or a fuel tank, we have what you need, and if you request our "Systems Service" we'll guarantee component compatibility; that is, your transmitter, receiver, servos, etc. are guaranteed compatible with each other to form a true Radio Control System. We have our own preplanned systems too; they're the most complete outfits available anywhere in the world. Find out more about KONAC . . . just like our service, our Systems Catalogue is straight to the point. We give it away too.

The mail order firm that knows radio control . . .
and puts that knowledge to work for you.

Konac

P.O. Box 366

We pay All
Postage and
Insurance

RADIO CONTROL SYSTEMS

Vienna, Va.
22180

MICRO-TIE MARK II

The MOST in Wiring

MOST VERSATILE
for single to ten channel — for
1/2A to 4-engine scale

MOST QUALITY
glassboard, Mil Spec connector,
and all hardware

MOST IN EASE OF MOUNTING
will fit anywhere or can be mounted to the side of an Ancco,
Bonner, or Kraft servo

MOST IN SAVING CONNECTIONS
up to 44 solder joints and 6 plugs can be saved

\$795

SEE YOUR DEALER OR ACE R/C OR WRITE DIRECT

JUSTIN, INC.

BOX 135
SAN GABRIEL, CALIF.



kit, or built-up, with respect to the radio equipment. We have examined the service offered by Konac Systems and enthusiastically recommend it to the consideration of every RC'er. For further information, Circle #3 on the Reader Service Card.

Proportional Servo Adaptor—Crescent Industries, Inc. has announced their plans to market an adaptor for output wheel type proportional servos which will permit a nonsensitive neutral with a fast finish. This will make possible vernier control at high speeds while still allowing plenty of travel as maximum stick travel is approached. Price is \$2.50. Circle #4 on the Reader Service Card.

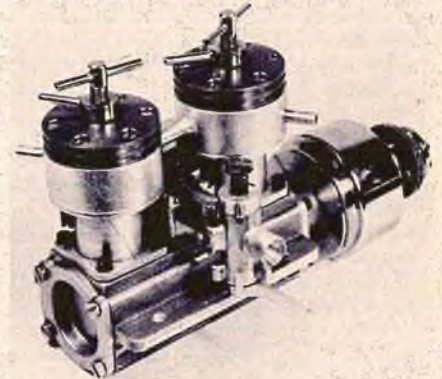

Taplin Twin Marine—Available from Westee Hobby Imports is a new mill for RC boat enthusiasts, the Taplin twin R/C marine 15 c.c. (.99 cu. in. displacement). This engine captured almost every major speed event in Europe during 1964 including the Blue Ribbon European Championships. Three anti-friction bearings are used on the crankshaft. Chromed sleeve and crankshaft. Extra high torque for high pitch props. Throttles down to 400 R.P.M. Since it is a twin, practically no vibration will be encountered. Includes universal joint. Overall height is 4 1/4", width exclusive of throttle is 2 5/8", length, 6 3/4". Price is \$97.50. Circle #5 on the Reader Service Card.

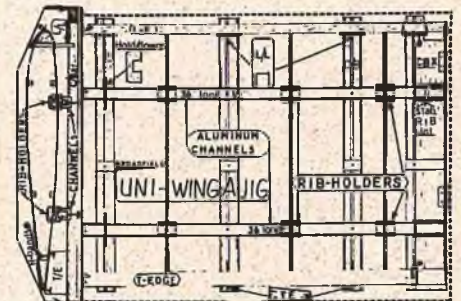

Uni-Wing-A-Jig from Broadfield — An improved and completely adjustable wing construction jig for spans of up to 72" and 12 1/2" maximum chord has been made available by Broadfield Air Models. Featuring adjustable rib spacing from 3/4" up, the jig may also be used for any size standard stabilizer design. The Uni-Wing-A-Jig features rigid, no-warp aluminum extrusion channels which retain the wing ribs

3 GREAT CHRISTMAS GIFT COMBINATIONS

from **WORLD WIDE**

\$17.50 BEST BUYS

Please indicate 2nd and 3rd choices

- Orion Kit
- Tauri Kit
- Delta Hustler Kit
- WW 5500 Battery Pack 500 MAH sintered button cells PLUS Dubro Compac Charger

\$17.50 buys any one of the above and remember, we pay the postage.

STOCKING STUFFERS

TOPFLITE PROPS
 (you get 12, pay only for 10)
 12/5....\$3.50 per box
 11/6....\$3.50 per box
 10/4....\$2.50 per box

Fast Links, adjustable
 clevis connector, 12 for \$2.95



Junior **FALCON**

SAVE \$18.83

Here's a perky package for the starter. You get: The fine Falcon Jr. Kit, the famous Baby Bee engine, and the long time favorite LT3 receiver, TTX transmitter, SE2 escape-ment from Citizen-ship.

ALL FOR **\$49.95**

Only from **WORLD WIDE RADIO CONTROL**

HINT — LEAVE THE MAGAZINE OPEN HERE



FALCON 56

SAVE \$62.25

Experienced modelers know and like this great Falcon 56 Kit. Combined with World Wide's Christmas special it is a real winner. Falcon 56 Kit, Enya 19 R/C engine, Citizen-ship 6 channel receiver, 6 channel transmitter and 3 multi servos.

COMPLETE PACKAGE **\$169.95**

GREAT TO GIVE — GREAT TO GET



SR. FALCON

SAVE \$95.80

Special for Christmas only, World Wide offers a really fine package for the proficient modeler. The new Falcon Sr. Kit, The big 45 R/C Enya engine, Citizen-ship 10 channel receiver and transmitter plus 5 multi servos. Purchased separately, this Christmas special would total for more than our low, low price of

\$279.75

RADIO CONTROL

9810 WYOMING, DET. MICH. 48204 dept. rc 12

Clip and paste to card for your free copy of "Quick Blips" or shoot us a dime for the latest World Wide catalog, don't forget your name and address.

- Please send me Quick Blips
- Here's my dime for a catalog

Circle No. 122 on Reader Service Page

securely in any desired spacing. Jig parts move into any position to align the leading and trailing edges with the ribs, with bands strapping to these members for assembly. This versatile construction jig is adjustable for tapered wings or even-chord surfaces. This is an excellent item for rapid, accurate wing and stabilizer assembly, and takes all of the guesswork out of this part of model construction. Price is \$21.95. Circle #6 on the Reader Service Card.

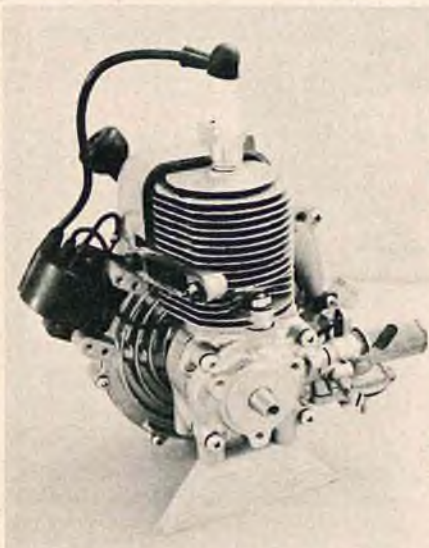

TAS Marine Engine — Acclaimed as one of the finest mills available for RC model boat usage, the TAS engine features a recoil starter, 18,000 volt ignition system, rugged construction, ball bearings, and the highest torque for an engine its size. Although it has 1.31 cubic inches of displacement, the TAS will fit in your hand. The carburetor is a diaphragm type which will allow positive fuel draw in any position. Forced air-cooling is built in. If the engine is to be enclosed in a sport or racing hydro model, a water cooled cylinder head is available at extra cost. The TAS P-7 is priced at \$41 including fuel tank, mixing canister, muffler, and tool kit. The P-7 model supercedes the P-5 which is similar with the exception of the carburetor and ignition system. While the P-5 model is no longer produced, service parts are available. A limited number of the older P-5's are available for \$35. Exclusive TAS distributorship assigned to G.E.M. Models. Circle #7 on the Reader Service Card.

The H-Ray and S-Ray by Andrews— Lou Andrews, noted R/C designer is now heading up Andrews Aircraft Model Company Inc., and has announced the release of their first two designs, the H-Ray and S-Ray. The former, a high wing ship for single channel equipment, has a 50" span with 425 sq. in. area. For .09 to .15 engines. The S-Ray is a shoulder wing configuration with the same dimensions, but



for .07 to .10 mills. Both kits feature Box-Lok prefabrication of a very unique and outstanding design. Both kits and subsequent designs will be available at local hobby dealers everywhere. For further information, Circle #9 on the Reader Service Card.

KRAFT PROPORTIONAL

(Continued from page 37)

Kraft system, in this given situation, is much the same as a reed rig. Interference will cause the surfaces to chatter slightly, but the pilot can still control the surfaces through the interference. Prolonged massive interference, again as with any system, will cause a "prang".

Let's take a look at how this might affect the pilot. It is a known fact that modern day multi designs will only fly a very, very short way without control by the pilot. Take any top design, such as the Candy or Kwik-Fli, whether reeds or proportional, then neutralize the surfaces by shutting off the transmitter and see how far it will fly before going into the deck! This, then renders a failsafe system rather useless, unless of course, you're flying a full-house Super Buccaneer! Assuming a vertical dive, for example, if interference is interjected and a failsafe occurs, you'd go right on in. With the Kraft system, the surfaces would chatter, but you would retain enough control to "fly through" the interference and recover from the dive. With the Kraft concept, the RF is so solid and well developed that "lockout" is unnecessary.

The new Kraft proportional system is the result of several years of work in proportional guidance systems, and the seventh design to be considered and tested by this concern. Phil Kraft has stated repeatedly that they would not release a proportional system into general production for the purpose of letting the consumer field prove (or disprove) the feasibility for a given design. Only when they were satisfied with the total reliability and performance of their proportional system would it be manufactured and made available through franchised Kraft dealer, according to Don Mathes, Chief Engineer.

This design seems to be "it". After thoroughly flight testing this system, and after observing several of these systems in continuous operation, in the air, we have made the statement that a proportional system is avail-

The PROVEN POWER PLANT for LARGE R/C MODEL BOATS

2 MODELS AVAILABLE FOR CRUISERS... RUNABOUTS... HYDROPLANES...

O & R COMPACT

MODEL "C"

Air Cooled

(flywheel
blower fan)

only

\$41.69

PLUS \$1.00 POSTAGE
AND HANDLING

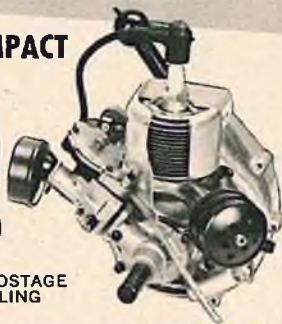

O & R COMPACT

MODEL "C/WC"

Water Cooled

(water jacketed
cylinder)

only

\$47.25

PLUS \$1.00 POSTAGE
AND HANDLING

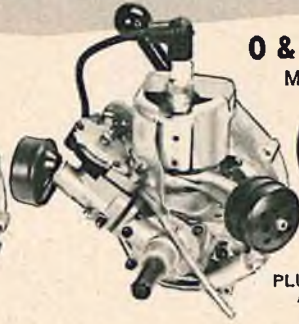

CHECK THESE FEATURES:

- Bore: 1.250
- Stroke: 1.031
- Displ.: 1.25 cu. in (21cc)
- Weight: 3⁷/₈ lbs.
- Runs on regular gas & oil
- Built-in recoil starter
- Built-in magneto ignition
- Single jet carburetor with choke and throttle
- Fuel Regulator
- Steel connecting rod with roller bearings on crank and wrist pin
- 2 piece crankshaft on four roller bearings
- Exhaust collector ring for cleaner boat interior
- Reed Valves



Octura Cast-aluminum Mount for above engines—\$6.95

Octura Universal Joint for connecting either engine to 3/16" dia. shaft—\$3.75

Octura Cast-aluminum Exhaust Stack—\$3.95

If Dealer Cannot Supply You, Order Direct:

OCTURA MODELS FOR BETTER R/C MODEL BOATING

8148 N. Milwaukee Ave., Niles, Ill. 60648

Send Stamped Self-addressed Envelope for FREE Model Boat Literature

Circle No. 124 on Reader Service Page

Molded Fiberglass R-C Boats & Fittings



1. AIR SEA RESCUE\$28.95
.09 to .29 glow plug engine.



2. FISHERMAN\$29.95
FITTINGS\$11.95
.09 to .19 glow plug engine, single or
twin ELECTRIC motors.

3. DLUXE Fittings
brass and plastic.
3 bladed brass
props 1 1/4" x 1 1/4"
to 2 1/2" x 2 1/2"
2 & 3 bladed
nylon props 1 1/4"
x 1 1/4" to 2" x 2"

Bow bumpers,
silencers, .09 &
up engines, pro-
peller shafts and
stuffing boxes,
rudder assemblies,
water scoops,
bits, cleats, anchors, blocks, pulleys, davits,
binnacles, bollards, capstans, searchlights,
many others.



4. BOAT KITS contain one piece impregnat-
ed molded fiberglass hull, pre-cut plywood
parts, pine chines, deck frames, plexiglass,
shaft, propellers, 2 sheet plans.

64 PAGES fitting, hull and boat
kit catalogue\$1.00
BOAT KIT information sheets15c

Fibo Craft Models

31 N. Clinton Ave. Bayshore, N.Y.

Circle No. 125 on Reader Service Page

**FINEST
AVAILABLE
NOW!**

FOR **SPEED**
FOR **SPORT**

TAS

MODEL P-7
\$41.00



- High torque
- Recoil starter
- 18,000 volt ignition system
- "Hop up" parts available soon
- Ruggedest construction in the industry
- Water cooling available
- 1.31 cubic inch

MORE ENGINE—FOR LESS MONEY
ALSO—TAS MODEL P-5 "BETTER" ENGINE—\$35.00

SUPER CHALLENGER — G.E.M. FIBRE-GLASS KIT

The "TAS" and the "Super Challenger" compliment each other. Get the MOST out of your engine with the BEST in a boat.

See previous G.E.M. ads for complete line of boat kits and parts. Terms—F.O.B. Lombard, Illinois. Sorry—No C.O.D.'s. Add 10% the cost of the order for shipping charges (\$5.00 maximum in U.S.A.) Dealers' inquiries invited.

G.E.M. MODELS 48 WEST LE MOYNE LOMBARD, ILLINOIS
EXCLUSIVE "TAS" DISTRIBUTORS IN THE MODEL INDUSTRY

(Continued from page 59)

able with the reliability of a top reed rig, yet with the fine, discriminating performance to be expected of proportional control. During the days we flew this system in the Mathes 'Digger' design, we simply plugged in the battery pack and flew. Control response was precise and exact. All tests were conducted in the interference cluttered metropolitan Los Angeles area, yet no interference problems were encountered. Reed systems and other Kraft proportional prototypes flying simultaneously on adjacent channels provided no interference problems whatsoever. Temperature changes had no effect on servo response. There was no servo drift or deadband. Outside of elevator trim, it was not necessary to use the trim functions at all. At the end of each day's flying session, the battery pack was recharged, and we were ready for another day's flying. It was as simple as that.

When we asked Phil Kraft for his opinion as to a reliability comparison between the new system and his standard ten or twelve channel reed rigs, he replied, simply: "When you consider the installation, usage, and reed maintenance in the hands of the average flier, the new proportional system is equally as reliable as a reed system, if not more so."

We are truly standing on the threshold of the age of proportional control. We are proud to present this basic flight review of the new Kraft system. Since it will not be available until shortly after January 1st, 1965, and since it does represent several new and unique engineering design concepts, we have not presented a laboratory analysis of this system. Rather, we have presented a basic flight report and some of our own opinions concerning the system.

The manufacturer of the Kraft proportional system is Kraft Custom Radio, 2519 Lee St., South El Monte, California. Available through Kraft franchised dealers on or about January 1. Price: Under \$600.

QUALITY YOU CAN DEPEND ON

Bonner DURAMITE MULTI-SERVO \$12.95

Bonner DURAMITE SUBMINIATURE ELECTRIC MOTOR \$3.95

Bonner TRANSMITE MULTI-SERVO \$29.95

Labels: 5 POLE ARMATURE, BRUSHES, 93% SILVER, 7% GRAPHITE, CENTERLESS GROUND SHAFT, OILITE BEARINGS.

The design and production of R/C actuators must be of high quality in order to prevent malfunctions and loss of control.

Another, less obvious requirement is to prevent drop-off of performance from wear during long-life usage. Otherwise periodic adjustments will have to be made in the system.

The exceptionally high quality of Bonner R/C actuators provides insurance, both against malfunctions and performance changes during long-life usage.

Bonner R/C products are sold by leading hobby shops throughout the world.

BONNER Specialties, Inc. 9522 W. JEFFERSON BLVD. CULVER CITY, CALIF.

CANADA

WESTERN CANADA'S FASTEST
GROWING MAIL ORDER HOUSE

CALGARY HOBBY SUPPLY

7417 23 ST. S.E. CALGARY
ALBERTA

R.C. SPECIALISTS

AUTHORIZED KRAFT DEALER

Everything for the Aeromodeler

Full line of all major mfgs. Most deliveries
from stock. Complete stock Sig Balsa wood.
Check our prices first.

Send 25¢ for catalog

The "CAPITOL SPECIAL"



The Capitol Special is one of the most realistic looking non-scale R/C models on the market today. For .09 to .15 power, weight ready to fly 32 ozs. Wide cabin allows plenty of room for radio gear. Kit is complete with pre-cut parts. This model will offer the flyer something really nice and different when built. **WINGSPAN 48" • POSTPAID • \$10.95**
KEYSTONE MODELS P. O. BOX 173 DUNCAN, P.A.



NOW AVAILABLE

PRECISION MOLDED NYLON CASE TO FIT M.M. MOTOR
Rebuild your broken or worn out M.M. into the best available servo motor for G.G., R.O. and other pulse servo's.

Bearing quality nylon, needs no lubrication.
UNBREAKABLE — CAN NOT BE WORN OUT
Case Only \$1.50
Trade-in, Rebuilt — Exchange \$2.95
New Motor with Nylon Case \$3.95

NORTH AMERICAN HOBBIES

ROUTE 1, BOX 235 PETERSBURG, MICH.

Circle No. 128 on Reader Service Page

Circle No. 129 on Reader Service Page

Circle No. 130 on Reader Service Page

(Continued from page 52)

thrust. If you are flying the BC-22 proportional system, don't give violent amounts of left or right — easy does it! If you get into trouble, don't fight the knob — just bring it back to neutral and let the plane fly itself out.

The biggest tendency to overcome when, for example, your model goes into a right spiral, is to counter with full left! Before you know it, you're weaving all over the sky and on your way to a prang! This model will free-flight quite well when trimmed out properly and will fly itself out of any difficulty you may get it into if given a chance. When in doubt... let it have its head.

When you land, bring it gently around into the wind, straighten it out, and it will land hands-off. If you're slightly cross-wind, a small amount of correction with rudder

may be necessary.

And there you have it. A Sunday flier that will be good for many a flight and a barrel of fun. Seven dollars and four cents for an airplane and engine, and forty-nine or fifty-nine dollars for a radio system, and you're into a wonderful hobby. If you're an old-time sport flier, put a D.Q.A. together, take it out to the local field, unfold your canvas chair, erect your umbrella, pour a cup of coffee, have your wife launch the plane, and have a ball!

It's the only way to fly!

NEW

NYLON BEARINGS
SEMI PNEUMATIC TIRES

SCALE WHEELS

SMOOTH CONTOUR TYPE

Free Rolling SC Wheels Pair

| | | |
|-----------------|------|--------|
| 2 1/4" Diameter | SC-1 | \$1.45 |
| 2 3/4" Diameter | SC-2 | \$2.25 |
| 3 1/4" Diameter | SC-3 | \$2.95 |
| 3 3/4" Diameter | SC-4 | \$3.95 |
| 4 1/4" Diameter | SC-5 | \$5.95 |
| 5 1/4" Diameter | SC-6 | \$6.95 |

SC Wheels Complete With Brakes

| | | |
|-----------------|--------|--------|
| 2 1/4" Diameter | SCB-7 | \$3.95 |
| 2 3/4" Diameter | SCB-8 | \$4.95 |
| 3 1/4" Diameter | SCB-9 | \$6.95 |
| 3 3/4" Diameter | SCB-10 | \$7.95 |
| 4 1/4" Diameter | SCB-11 | \$8.95 |
| 5 1/4" Diameter | SCB-12 | \$9.95 |

FUEL TANKS

NEW LEAKPROOF CAP

SIX SIZES

- NO THREADED CAP
- NO GASKETS
- WEIGHS LESS
- LESS SPACE REQUIRED

| | |
|--------|--------|
| 1-oz. | \$1.25 |
| 2-oz. | \$1.35 |
| 4-oz. | \$1.55 |
| 6-oz. | \$1.65 |
| 8-oz. | \$1.75 |
| 12-oz. | \$1.85 |

NYLON SPINNERS

PARABOLIC SHAPE

Two Piece Construction
Back piece is held with Prop-nut and washer.

| | |
|-----------------|---------|
| 1 3/4" Diameter | \$.79¢ |
| 1 1/2" Diameter | \$.89¢ |
| 2" Diameter | \$1.19 |
| 2 1/4" Diameter | \$1.29 |

6719 SALT LAKE, BELL, CALIF.

MINIATURE JUNCTION BOX

FOR R/C SIMPLIFIED WIRING

- Saves on plug cost
- Simplifies wiring equipment
- Weighs only 1/2 oz.
- Size 1/2" x 1" x 2 1/4"

Complete with circuit board and grommets, ready to wire.

Price Only \$2.25

FORMERLY "LINDWOOD ACCESSORIES" PRODUCTS



Bob Angus, Tucson, Arizona. A clean, good looking ship of more conventional design.



Rogers Barton, Corpus Christi, Texas, and a Class I design that evidences an all new design trend.



Ben Harr of San Antonio, and the 48" version of his well-known Separator series. 5 1/4 lbs., 380 sq. in., 32 ounce wing loading!

(Continued from page 41)

dominant next year in order to gain smoother performance and greater versatility in Class I competition.

The prospect of larger Class I planes presents a problem for the average Sunday sport flier. Since the ideal condition for this segment of Class I participation exists where contest planes and sport-beginner models are most similar, any trend toward increased complexity brings on what may be conflicting aims and goals. The sport flier, comprising the vast majority in RC activity, looks for minimums in the way of radio, aerodynamics, and construction. Simplicity is his by-word in order to match the time and/or talent available. Most RC'ers who have been around awhile know many beginners who really never get started since

their initial projects were too complicated or ambitious.

In discussing this condition with many modelers and in analyzing flying conditions as they most usually occur for sport fliers, it is seen that RC flying for both segments, sport and contest, is most successful where the two work in a teamwork arrangement — an association not formally recognized as such, but a team nevertheless. I'll explain this by getting back to the San Antonio story:

Unlike many portions of the country, class III flying in San Antonio is secondary to Class I, the latter known for its quality of performance. This results from significant leadership in Class I which, in turn, provides new ideas, testing, and motivating confidence, for sport fliers and beginners in the area. The sport fliers and beginners, in turn — (and this is where the team work develops) — build and fly the Class I products developed locally. In doing so, they

confirm or otherwise test the feasibility of the designs or concepts. Understand, it's no formal arrangement, but it does occur and the accumulated experience becomes invaluable.

As a prime example, consider the history of the Separator, mentioned earlier. Ben Harr has nurtured this basic design since 1955 and through many sizes ranging up to nine feet. Sport builders such as Charles Barron, Jim Albers, Bud Williams, Val Hutchins, Jim Houston, Bill Batto and literally dozens of others, who never had either the time or inclination for contesting, built this rugged simple airplane and thus continued to confirm its worth while sustaining confidence in it over the years. This helped to keep the design alive so that additional serious development could be continued by Harr, Petri, and yours truly, based upon contest needs and experience, and augmenting the important contributions of the sport group.

The San Antonio story — that is, the development of an airplane through an informal team effort, in reality, is certainly not a condition confined to one area alone. I know that, as many of you read this column, you will recognize similar elements in your own locality — elements of specific instances of significant leadership — material contributions that have brought about progress in this hobby.

I guess it could be said that RC'ing is made up of individualists who instinctively know that our hobby is more gratifying when working together.

UNI-VERSAL **UNI-WING-A-JIG** **FEATURES:**
 by **Broadfield** **WITH ALUMINUM CHANNEL SPARS** • Adjustable • Rib-spacing • Chord to 12" • Span to 72"
 --secure • Adjustable • Rib Holders--

IMPROVED
 WING & STABILIZER BUILDING JIG FOR ASSEMBLY OF LEADING -R/C- MODEL SURFACES.
 HYBRID - ALUMINUM (EXTRUSION) CHANNELS ASSURES NO-WARP JIG-PICTURE -- PLUS -- OVER -132- PRECISION CUT - PREFABRICATED JIG-COMPONENTS WHICH WILL SUPPORT (ENTIRE) ASSEMBLIES IN POSITIVE ALIGNMENT FOR TOTAL CEMENT-UP, ADAPTABLE-EVEN-CHORD OR TAPERED WINGS & STABILIZERS, ACCLAIMED BY H/Cors "JUST WHAT I'VE BEEN LOOKING FOR"

WIROED FOR ANY-DEGREE DIHEDRAL
 ALSO AVAILABLE IN SPACING
 1/2" - 1" - 1 1/2" - 2" - 3" - 4" - 5" - 6" - 8" - 10" - 12" - 14" - 16" - 18" - 20" - 24" - 28" - 32" - 36" - 40" - 44" - 48" - 52" - 56" - 60" - 64" - 68" - 72" - 76" - 80" - 84" - 88" - 92" - 96" - 100"

UNI-WING-A-JIG (U-WJ-72) \$21.95
 with Stabilizer Jig Set-Up include
 Ask Your Dealer or order Direct
BROADFIELD AIR MODELS
 ASH AND MASS. U.S.A.

2-1/2" H/HOLDERS-36" CHANNELS-HINGES-SCREWS, ETC. \$15.95. (FOR-FASTER-SERVICE-write-US-direct.)

Circle No. 139 on Reader Service Card

ARIZONA—Tucson

DON'S HOBBY & CRAFTS SHOP
 5329 So. 12th Ave.
 Tucson, Arizona
 Ace-Kraft Franchised Dealer
 Sig Balsa
 All Supplies Stocked

CALIFORNIA—Santa Monica

RADIO CONTROL
 Sailplanes Boats Planes
WILSHIRE MODEL CENTER
 1326 Wilshire Blvd.
 Santa Monica, California
 IMPORTED & DOMESTIC HOBBY SUPPLIES

ILLINOIS—Chicago

STANTON R/C, INC.
 4734 Milwaukee
 Chicago, Illinois 60630
 Trade-In Your Old Engines & RC Gear
 Send 10 cents For Used Equipment List

MASSACHUSETTS—Lawrence

Merrimack Valley's Most Complete Hobby Shop
MODELER'S HAVEN
 80 Manchester Street
 Lawrence, Mass. 01841
 Phone: 683-3222 Open Daily Till 9:00 P.M.
 Saturday Till 6:00 P.M.

NEW JERSEY—Wayne

Specializing in Model Aircraft & R/C Equipment
CARL'S HIGHWAY HOBBIES
 689 Route 23 — Wayne, N.J.

NEW YORK—Utica

Complete Selection For R/C Filers
 Bobcock
 Bonner
 Min-X
 Kraft
 Citizen-Ship
 Sig Balsa
 ... and 40,000 other items for all modelers.
A & J HOBBY HOUSE
 19 Auburn Avenue Utica, New York

OHIO—Kirtland

**KIRTLAND HARDWARE
& HOBBY SHOP**
 Route 306 — Kirtland, Ohio
 1 Mile South of U.S. 90

OREGON—Hillsboro

Orbit Controlaire Rangemaster
HILLSBORO HOBBY SHOP
 321 East Main Street
 Hillsboro, Oregon
 New 10-Channel Transmitter & Receiver
 \$99.95
 Open Till 8 P. M. 9 P. M. on Fridays

OREGON—Portland

The Northwest's Largest R/C Dealer
HOBBYLAND
 4503 No. Interstate Ave — Portland, Ore.
 Only Proven Quality Equipment Stocked

TENNESSEE—Nashville

The South's Largest R/C Dealer
NASHVILLE HOBBY CENTER
 903 Church St. Nashville, Tenn.
 Biggest Supply in the South
 Built up RC Planes — Trade-in Buffets!

TEXAS—Dallas

Radio Control Headquarters For The Southwest
BERNIE'S HOBBY HOUSE
 209-A W. Jefferson
 Dallas, Texas
 Professional Flying Instruction At No Extra Cost

WISCONSIN—Milwaukee

OKLAHOMA HOBBY SHOP
 1103 W. Oklahoma Avenue
 Milwaukee, Wisconsin 53215

WEST VIRGINIA—Huntington

THE MODEL SHOP
 1931 E. Washington Avenue
 Huntington 4, West Virginia
 Open Noon Till Eight
 If you want it, we have it—in stock!

ENGLAND—London

HENRY J. NICHOLLS & SON LTD.
 308, Holloway Road
 London, N. 7, England
 For All European RC Items Including
 Marce Power Units
 Write for List

KEN WILLARD*(Continued from page 49)*

most frustrating problems there is — both to the modeler and the manufacturer.

I'm sure you've been out at your flying field and heard some modeler say "Blast that blankety blank — equipment. I'll never use it again. It's no good!" Meanwhile, all over the country, hundreds of other modelers are having great success with the same equipment.

More often than not, the blame on the manufacturer is misplaced. The modeler has not read instructions, or has faulty connections, batteries, switch or a bad installation (like tightening down the backplate of an escapement to a warped bulkhead, thus twisting the escapement out of adjustment).

You will be interested to know that it's an absolute fact that most radio equipment returned to the manufacturers for service is found to be in good working order. Long ago I learned to send stuff back with a note describing what happened, because half the time it was not the equipment but rather the way I was using it. Not always, though, and this is why it's important for you to be understanding.

At the prices which our hobby equipment is sold, it is necessary for manufacturers to use components with fairly broad ranges of performance. Usually the factors tend to balance out when the total circuit is completed, and a completely satisfactory unit results. Occasionally, though, the tolerances all add up in one direction, then the unit becomes marginal. It may pass the bench check for shipment, but after a very short time may cease to work. By that time you've got it installed, and "The blankety blank thing is no good!" You're right — and believe me, the manufacturers

want to fix it even more than you do. Their reputation is at stake.

So, if your equipment doesn't work, even after a thorough checkout, don't cuss it — send it back, but describe the symptoms. But, before you do, be sure you're on firm ground. It's always embarrassing to get a note that says something like: "Sorry you had trouble, but you should have made that current check with the switch off, as it says on page 3 of the instructions."

Since you and I and the manufacturers are all in this together, we have to work together. So if, after a reasonable time, you don't get any reply from an inquiry you've sent to a manufacturer, let us know. Maybe we can help. We'll try.

Let me close with a portion of a letter received from Ed Lowe of Holdingford, Minnesota.

"Thank goodness someone has at last recognized that there is such a critter as the "Sunday flier"! I have been one since the tail-end of the bending-bamboo-over-a-candle-flame era. I have dabbled in hand-launch gliders, tow-line gliders, 10c Comet models (especially the 10c and 25c Comet kits of the Curtis Robin), scale rubber, contest-type rubber, scale gas, contest-type free-flight gas (I mean gasoline, with points, condenser, coil, flight batteries, booster batteries, 3-1 mix, etc.) scale U-control, stunt U-control, (my first yo-yo was Walker's Fireball), R/C since Citizenship's 465 (or was it 456 mc outfit?) — and have attended contests as a fascinated spectator. But as far as competing? No, thanks, I'll fly for fun. So far, I am still in the single-channel stage of R/C. Sure, I would sort of like to go multi, but why bother? I still haven't made the most of single-channel... Long live the "Sunday flier"!!

Now there's an "old-timer new-comer!" If we can help guys like Ed — as well as some of you who are completely new to the R/C hobby — then you Sunday fliers can trade problems and answers through this column. Tell me what you'd like to have discussed. Meanwhile, I'll finish up the plans for the sport biplane and get them out for you next month.



NOW IS THE TIME TO SEND A FRIEND OR RELATIVE A TWO YEAR OR ONE YEAR CHRISTMAS GIFT SUBSCRIPTION TO R/C MODELER MAGAZINE — A GIFT HE'LL RECEIVE AND ENJOY EACH MONTH OF THE YEAR, KEEPING HIM UP-TO-DATE ON EVERY ASPECT OF HIS FAVORITE HOBBY. SEND YOUR GIFT SUBSCRIPTION ORDER TODAY — A GIFT CARD WILL BE SENT IN YOUR NAME IN TIME FOR THE CHRISTMAS SEASON.

Christmas Gift Subscriptions

R/C MODELER Magazine

Subscription Department

P.O. Box 487

Sierra Madre, California

Amount enclosed: \$.....

Please enter the following Christmas Gift Subscriptions as indicated:

Name..... 1 Year at \$5.50

Address..... 2 Year at \$10.00

City..... State.....

Name..... 1 Year at \$5.50

Address..... 2 Year at \$10.00

City..... State.....

Please send gift card in name of:.....

FROM THE GROUND UP

(Continued from page 40)

would if completely R/C'd, then you'll have to calm down your power plant. Props on backward or restricted throttles will help. Another trick would be to add weight comparable to the equipment weight in the form of old batteries, etc.

If these tests are successful and you make it to the "installing R/C equipment in the above model" stage, spend a good deal of time making sure you get the proper balance.

For more precise, step-by-step information, pick up a copy of some of the fine books on the subject. Publications such as Bill Winter's latest, "How to Build R/C Models" should be on every R/C'er's bookshelf. While you're book-browsing, look for some of the equally fine helpers written by Howard McEntee. These compilations take over where columns leave off. They have the space required to take a problem from its inception to a workable conclusion. Of course it's not possible to cover every aspect of every problem or situation. You have to implement these answer books with some common sense of your own.

Anyway... I'll be interested to hear more from Art as his R/C modeling career progresses.

We really did receive a letter from a modeler interested in a full-house rig from the beginning! And if you think I'm going to go on record as discouraging him, you're wrong! With my luck he'll be successful, fill the thing with bombs, fly it directly over my work bench, and — POW!

Occasionally a modeler can start his R/C career in high gear and do a commendable job. Unfortunately, the chances for success seem reserved for a charmed minority. The rest who fail when starting at the top, frequently are lost to the R/C hobby for all time.

Don't misunderstand — I'm not against starting at the top, it can be done with success. Starting somewhere is important... but staying with it and enjoying it is even more impor-

tant. After all, what is any hobby? It's a form of relaxation... something you enjoy doing to get your mind off other things you have to do, but enjoy less. If one modeler gets his "jollies" R/Cing an old converted free flight model on single channel, who's to say he's wrong because he's not following the "accepted" pattern? What is the "accepted" pattern and who determined it?

There is not, nor should be, any pre-set pattern for how you must enjoy any hobby. There are, however, a few fundamental steps some of us more battle-weary veterans have found to be safer to follow than others. And this usually takes the form of doing some exploratory creeping before breaking into a full gallop. To be sure, this often appears to be a big compromise in the eyes of the more adventuresome in our midst. The record books show, though, that however conservative this preferred beginning may seem, chances for ultimate success in more advanced pursuits of the hobby at some later date are much better.

This is a hobby to be enjoyed — one that can be enjoyed in any one of several ways. So pick your plan and "have at it." If you do a little "modeler watching," you'll notice the group is frequently made up of the builders, the designers, the fliers, the pilots, other watchers, contestants, organizers, protagonists, and usually a couple who aren't quite certain just what form their identity takes. Look a little closer and you'll usually see that each one is enjoying "his" hobby and the role he's chosen to play in it.

So much for institutional advertising! What have you done recently that others might find interesting? We're always receptive to cards, letters, and pictures of what modelers everywhere are doing.

No one denies that R/C has progressed to a rather clearly defined art. The days of the "home brew" receivers and transmitters are gone — replaced by "factory built" reliability (thankfully!). Even the electronic kits — the last contact most of us have with the days when you had to do it yourself or do without — remove as much of the risk involved as possible.

But, just when you feel you've

passed completely into a new era, some old bugaboo left over from that forgotten time crops up anew to plague the unsuspecting! One such vestigial remnant from the dawn of R/C began to show its ugly head recently at our flying field. It had been so long since such a problem had occurred that many of us were a while recognizing it as plain old vibration reacting on a reed bank!

When reed banks drove a flock of relays there were frequent instances of vibration causing unwanted control action. As receivers became relayless, the vibration problem seemed to disappear, for it was the individual relay which was more susceptible to vibration — the reed banks seemed to be able to hold their own.

We asked ourselves why this should occur now if it hadn't been a factor in the past. The reason seemed to be a combination of increased engine size and a lack of attention to receiver placement.

In the case in point, the receiver had been installed so that the reciprocating action of the engine was reacting upon the entire reed bank contact plate. If such a condition should occur in your set-up, try repositioning your receiver... it frequently clears up the trouble completely.

Like to tinker? (I know. If you didn't you wouldn't be in R/C!) Here's a question from George Black of Galesburg, Illinois which may start you thinking — may even be something you've tried. If so, drop us a few notes.

George writes that he is curious to learn if anyone has made an attempt at C.A.R. with a galloping ghost system. My curiosity is aroused, too.

On the surface, this would not seem to be a compatible combination. However, there are probably many modelers who have thought about such a setup. I learned a long time ago not to pre-judge the possibilities of any R/C application! If you've tinkered with anything along this line, please drop us a line so we may share your experiences with others. Who knows, maybe you'll open up a whole new control concept!!

... or another Pandora's Box! And, speaking of boxes, drop a line c/o P.O. Box 2555, Schenectady, N.Y. 12309.