

AEROBATIC BIPE FOR FREE-STYLE EVENT

RADIO CONTROL

DECEMBER/1965/50c

MODELER

THE LEADING MAGAZINE FOR RADIO CONTROL CDC

RCM DIGITRIO
RECEIVER

YOU CAN BUILD
SK DADDLE TOO
HALLETT 'SK' BOAT

USE YOUR AUTO
FOR
CHARGING NICADS

SUNDAY FLIER

TOP OUT

**NORTHROP, HILL
SET WORLD RECORDS**
ALTITUDE, STRAIGHT LINE
R/C MARKS SHATTERED



VECO QUALITY

KITS



Jim Kirkland's BEACH COMBER

The most complete RC kit you can buy for standard or proportional RC. Perfect for training or contest flying. Simplified construction includes precision die-cut full-size fuselage sides, 4" wing balsa, complete hardware package including nose gear, Nylon bell cranks; full-size detailed plans showing receiver, servo and mechanical installation of three RC equipment options. See the Beach Comber at your dealer. R-5.....\$29.95

ENGINES

Veco 45RC



Power your new Beach Comber, or any other large RC ship, with the Veco 45RC, the engine that has been used by more national and international contest winners than any other engine. The Veco 45RC is the choice of experts for full-range power and reliability for sport or contest flying.

bore .850 • stroke .820 • displacement .465
• safe idle 2000 rpm • coupled exhaust/
intake throttle control

Send for our free booklet, "How To Obtain Reliable Idle & Maximum Performance From Your VECO 45RC," by Clarence Lee.
GP-45RC\$34.95

FUEL

Veco Power Fuel 1

Here is the fuel to insure optimum performance for your Veco engine. Veco Power Fuel 1 is blended to provide even-burning-power from idle to maximum RPM. And it lubricates your engine efficiently for long-life and trouble-free operation.

The perfect fuel for R/C •
Free-Flight • C/Line

95c/pint \$1.65/quart \$5.95/gallon

Ask for VECO products at your hobby dealer
... engines • engine accessories • tanks
• wheels • spinners • hardware/send 10c
for 1965 catalog.



VECO PRODUCTS CORP.
P. O. Box 229, Burbank, Calif.
a subsidiary of Henry Engineering Company
MP65403

RADIO CONTROL

MODELER

DECEMBER 1965

VOL. 2 NO. 12

Editor • Don Dewey
Production Editor • Chuck Waas
Contributing Technical Editor • Ed Thompson
Art Editor • Dick Kidd
Art Assistant • Barry Halsted
Contributing Editors •
Ken Willard
Jerry Kleinburg

Gary Preusse
Bernie Murphy
Chuck Cunningham
Foreign Editor • Cliff Rausin
Club and Contest Editor • Kathleen Acton
Special Projects • Bill O'Brien
Administration & Reader Service •
Betty Rives

Features

RMC DIGITRIO: PART IV	18	Ed Thompson
THE SHOWOFF	27	Chuck Cunningham
USE YOUR AUTO FOR CHARGING NICADS	31	Jack Sellors
BUILD THE SK DADDLE TOO	40	RCM Boating Staff
RCM PRODUCT REPORT	47	RCM Technical Staff

Departments

EDITOR'S MEMO	5	Don Dewey
SHOWCASE '65	12	RCM Technical Staff
CLUB AND CONTEST NEWS	32	Kathleen Acton
REGATTA	35	RCM Boating Staff
TOP OUT	44	Jerry Kleinburg
SUNDAY FLIER	45	Ken Willard
N.M.P.R.A.	46	Bernie Murphy
THE ROOSTERTAIL	50	I.M.P.B.A. Staff
KITS AND PIECES	53	Bernie Murphy
THE LAST WORD	74	George Hickson

The Cover

Hal deBolt poses with his modified Class III Interceptor. This month, RCM salutes Hal for his outstanding contributions to the sport and hobby of Radio Control.

R/C MODELER CORPORATION, Publisher
Editorial and Advertising Office
P. O. Box 487
Sierra Madre, California 91026
Phone (213) 356-1066
Business and Circulation Office
P. O. Box 1128
Laguna Beach, California 92652
Phone (714) 494-0768

Official Publication of
The National Association of Radio Control Clubs
International Model Power Boat Association
National Miniature Pylon Racing Association

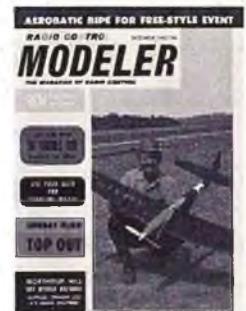

Subscription service: All subscription correspondence should be addressed to R/C Modeler Circulation Dept., P. O. Box 1128, Laguna Beach, California. Please allow at least six weeks for change of address. Include your old address, as well as new — enclosing an address label from a recent issue whenever possible.

Editorial contributions: must be accompanied by return postage and will be handled with all reasonable care. Publisher assumes no responsibility for return or safety of art work, photographs, or manuscripts. Address editorial contributions to The Editor, R/C Modeler Magazine, P. O. Box 487, Sierra Madre, California.

Subscription rate: One year, \$5.50, 2 years \$10.00. Canada, one year \$6.00. All other countries, one year \$6.50. Payment from all countries must be in U. S. funds.
R/C MODELER MAGAZINE is published monthly by the R/C Modeler Corporation. Contents copyright 1965. All rights reserved. Printed in U.S.A. Second Class Postage paid at Milwaukee, Wisconsin and at additional mailing offices.

EDITOR'S MEMO

by Don Dewey



THIS month, R/C Modeler Magazine is proud to dedicate the December issue to the Academy of Model Aeronautics as a salute to its thirtieth anniversary of service to model aviation. By tradition, an anniversary should be a joyous occasion — a time for celebration. A time for reminiscing about past accomplishments. And a time for planning toward meeting the new challenges and goals of a promising future. As for the past . . . the Academy's record is an enviable one. A tradition of hard work and self sacrifice on the part of many dedicated leaders of model aviation to bring you and I the many advantages we enjoy today in model aviation.

But the future . . . that is another story. For, my friends, there may be little future for the Academy of Model Aeronautics. An anniversary that brings with it a grim outlook for the organization that dedicated years to bring you and I everything we derive from this hobby — our flying fields, our radio frequencies, and even the radio equipment and aircraft designs we use today. And without the full efforts of the Academy of Model Aeronautics, the future of model aviation — and our specialized phase of radio control — would be compared to a nation without a government, or a corporation without leadership or organization.

The A.M.A. is the backbone of model aviation activity. Yet only a fraction of the total model fliers — and RC'ers in particular — have cared enough to invest six dollars toward the future of the hobby and sport to which we are supposedly dedicated. With this fraction of the total modeling fraternity, the A.M.A. has worked under tremendous and undeserved hardships, using that small hub of members to obtain the benefits which all of us enjoy. The eternal paradox of a democratic society — you don't **have** to belong . . . you don't **have** to actively participate . . . you don't **have** to step forward. You're going to reap the benefits anyway, since there is seemingly always the dedicated, hardworking minority around who care enough to do the work for the majority. Except for one small item. This time the minority has worked to its capacity and it's not enough to do the job — to cope with the

expanding problems and tremendous increase of participants in our hobby. So we have come to the crossroads. A time for decision. A time to decide whether this hobby has a future . . . or only a past. Maybe you think your six bucks — your membership in the Academy brings you only a card, a monthly magazine, an insurance policy, and the right to put a flying license on the wings of your latest R/C bird. Let's take a good look at what that six bucks buys you.

It buys you over seven hundred A.M.A. sanctioned competitions each year, plus the biggest one of all — the National Model Airplane Championships. It buys the competition that develops the radio gear you use each weekend. Without this competitive development, you, the sport flier, would not long be out on the Sunday flying field.

It buys you the frequencies on which you fly. The present Citizen's Band frequencies for R/C were obtained for all modelers by that same small hub of members back in the early 1950's. That same small nucleus is again working for new frequencies on the 72 mc band and almost has them, frequencies I am quite sure you will be more than happy to use when they are available.

It buys you effective legislation, and a counter-fight against unfair legislation, in state and governmental lawmaking bodies.

It buys you International competition in R/C . . . an "Olympic" team that competes for individual and team honors with other nations of the world.

That single check for six bucks does all that and much more. It has provided you with the gear you use, the plane you fly, the contests you fly in, the radio frequencies you use, and the very right to use them when you do.

And yet, the A.M.A. is regarded by the vast majority as a competition-only group, despite these efforts for all fliers, and despite the fact that over half the A.M.A. members are **not** competition people! In other words, over half the A.M.A. members join for reasons other than direct competition activity, because for them the Academy is more than a

(Continued on Page 9)

Citizen-Ship



COMPLETE
Analog Proportional System
For UNDER \$250.00



- ★ Superheterodyne
- ★ Fail Safe
- ★ All Transistorized
- ★ Dual Simultaneous plus trimmable motor
- ★ The Intermediate Proportional—Ideal for Class I, Class II & Pylon AMA Flying
- ★ Tone modulated for maximum noise rejection
- ★ Reliability through simplicity of design
- ★ Size permits installation in practically any R/C Kit.

Suggested List Price\$249.95

Available in 26,995, 27,045, 27,095, 27,145,
27,195 and 27,255 mc.

CONSISTS OF:

APT Transmitter—including externally loaded antenna. Purchased separately—
Suggested List Price\$89.95

APR Receiver—Note Size: 1-11/16" X 1 3/4" X 2-1/16". Weighs 3 3/4 ounces. Purchased Separately—Suggested List Price.....\$74.95

2 APC Proportional Servos—Closed loop feedback. All nylon drive train for quiet efficient operation. NOTE SIZE: 2 5/8" X 1-9/16" X 1". Weighs 2 3/4 ounces each. Purchased separately — Suggested List Price\$34.95 each

(A third APC Servo may be purchased which can be paralleled with the rudder servo from a single output to obtain CAR.)

1 APM Trimmable Servo—Mechanically the same as APC above. Purchased separately—Suggested List Price.....\$25.95

1 Printed Circuit Wiring Board—Complete with switch and 5 plugs and sockets. Board circuit automatically does all interconnecting. Purchased separately — Suggested List Price\$12.95

Send for catalog of CITIZEN-SHIP'S
Complete Line.

Citizen-Ship

RADIO CORPORATION

810 East 64th Street, Indianapolis, Ind. 46220

(Continued from Page 5)

contestant's "club." It is a way of buying the largest insurance policy of all, the big group policy that will insure the future of model aviation — and in our case, Radio Control.

The Academy is trying, these days, to do a lot of things for all modelers, but it has the support of a comparative few. This can be brought home by the fact that there are approximately 75,000 to 100,000 RC'ers in this country, both active participants, and interested potential RC'ers, and yet less than 10% care enough about the future of this hobby to participate in its growth and development by supporting the one organization that made it all possible!

Let's take a look at the recent Nationals. It is the largest model spectacle in the world and a pure miracle that it ever comes off at all. If the average modeler had any idea of the amount of work put forth by the small handful of people that put this big meet across, they would be indeed surprised! Yet, there is little credit given to the Academy and the volunteers that make it all possible, leaving little incentive to others to want to be part of the Nationals or other major A.M.A. activity.

One of the major problems in this field lies with us, the model press. Most of us have been active in A.M.A. activities for so long that we take it for granted that all of you are aware that the Nationals, the Internationals, the local, state, and regional contests are all sponsored, promoted, and made possible by the Academy. Thus, we neglect our obligations by failing to mention any connection with the A.M.A. when reporting on these events. I, for one, can make this clear in one simple, concise sentence: Without the A.M.A. there would be no events to report on, and in fact, no model press in which to report them.

It all boils down to a simple fact that the A.M.A. **must** have your membership, your participation, if it is to be able to continue to put on the Nationals, the F.A.I. programs, the rules (good or bad), which tie our R/C activities together and provide us with the hobby we enjoy. Too many RC'ers, 90% of them in fact, are sitting back without realizing that they need to be A.M.A. members if they, or their kids, are to continue to enjoy so much of all this, whether it be Sunday sport flying or contest activity.

It's not a question of whether you get your money's worth in the liability insurance, monthly copies of "Model Aviation" magazine, and competition license that the A.M.A. provides. Rather, it's a question of whether all of this activity comes unglued simply because there is

WANT—

- MORE RELIABLE IDLE
- IMPROVED POWER
- QUICKER STARTING



The New FOX R/C GLO-PLUG Will Give It To You!

Basic element in the new Fox R/C Glo-Plug is a special missile-developed alloy that has better catalytic action than platinum-iridium. Exhaustive tests have proved it to be the best on the market — stronger at elevated temperatures, and with the best idling characteristics. Another big feature is the machined-on idle bar.

LONG OR SHORT — 98c EA.

FAMOUS FOX FUELS



SUPERFUEL	MISSILE MIST	DUKE'S FUEL
85c Pt.	95c Pt.	Gals. Only
\$1.89 Qt.	\$1.89 Qt.	\$3.50 Gal.
\$3.50 Gal.	\$3.50 Gal.	R/C Finest!

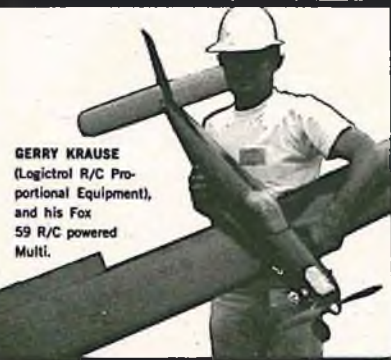

GERRY KRAUSE
(Logictrol R/C Proportional Equipment), and his Fox 59 R/C powered Multi.

FOX 59 R/C

Here's the champ of the big motors—the one that has the power and reliability to win! No break-in needed—flies at peak performance right out of the box. Exclusive Fox carburetion maintains proper low speed mixture at any altitude. Nearly a full horse to pull the big models through any maneuvers smoothly, dependably. List of users reads like "Who's Who in Modeling"



3995



EDD ALEXANDER
Fort Worth, Texas



duke's mixture

R/C flyer Reginald Matsil, a modeler of 20 years' experience and current Treasurer of the Long Island, N. Y. Drone Society, really likes our new R/C Glo-Plug. He writes: "I have flown many number of flights with my Merco 61 powered Taurus and never yet got the darned thing to idle right. I have since put in your new plug and all I can say is 'Holy Mackerel'. Without ever touching the idle control or air bleed, she began running smooth as silk and nice and slow at idle. Last Saturday I flew five flights and in every instance the old Merco fired up on the first flip."

My new Duke's Fuel quite well received. Primarily developed for R/C and Sport flying, it's a 15% Nitro brew with liberal additives for idle and mileage. Won't varnish; doesn't take the paint off, either. You should try it.

Made the trip to the NATS at the controls of our trusty Bonanza, accompanied by Bill James and Jay Davis of our company, and Jim Robertson of Austin, Texas. Flight time was approximately 7½ hours.

Snapped the Polaroid of Gerry Krause, consistent R/C winner and partner in EK Products, Inc., manufacturer of the Logictrol proportional radio gear. Gerry has used a Fox 59 R/C exclusively for the past two years in his contest and demonstration flying. Quoting Gerry loosely, "Once I discovered the power and performance of the Fox 59 R/C, I was hooked!"

Excessive fuel consumption can often be traced to worn bearing. Normal 59 R/C should consume less than an ounce a minute.

Like the sales results of Edd Alexander's enthusiasm for the Fox 59 R/C. That's him standing with the swept-wing Multi. Operates Edd Alexander's Hobby House, Fort Worth, Texas, and writes: "You know how I like the 59 R/C by the amount I sell. I checked my invoices, and I have sold 58 Fox 59 R/C engines the last 11½ months."

Did a double-take when a modeler approved of the "wall-to-wall carpet job" on the new motors. Our new 15 R/C and 35 Stunt packages are lined with flocked paper.

Thanks to all you Multi flyers who took the time to fill out my questionnaire. The wheels are now moving to give you just what you want, which is always the aim of Fox.



FOX MANUFACTURING COMPANY
FORT SMITH, ARKANSAS

IF YOU LIKE . . .

R/C MODELER MAGAZINE

. . . you'll be **WILD**

about the

R/C MODELER ANNUAL!

- ✓ OVER 100 PAGES OF ALL NEW R/C MATERIAL
- ✓ FULL SIZE FOLD-OUT PLANS
- ✓ FOR THE BEGINNER, SPORT FLYER, OR EXPERT
- ✓ HARD COVER FOR PERMANENT STORAGE
- ✓ A PRESENTATION OF THE FINEST R/C MATERIAL EVER PRESENTED BETWEEN TWO COVERS!
- ✓ ELECTRONIC PROJECTS, SINGLE AND MULTI CHANNEL CONSTRUCTION ARTICLES, GOODYEAR AND SCALE CONSTRUCTION ARTICLES

YOU WON'T WANT TO MISS IT!

AVAILABLE ABOUT FEBRUARY 15TH
FROM YOUR HOBBY DEALER



**NO HELP
NEEDED**
with an "all purpose"
R/C Field Box
by Broadfield

PROVIDES— OFF-GROUND

self-service (stand-up) plane station for re-fueling & testing. "Hold-A-Plane" adjustable brackets support plane waist high. "Hold-Down" stakes for use on windy days. Also provides plenty storage room for your meters, batteries, fuel, etc. Legs fold into bottom; carries like a suit case.

- EZY-to-Build: completely pre-fab KIT**
- Precision-cut plywood panels
 - Tapered bass-wood legs & anchor clips
 - "Hold-A-Plane" brackets-shaped
 - Hardware-N/P catches, etc. Packaged in Plastic reusable box
 - Assembly plan, Color decal, & glue.
 - "Ideal GIFT for R/C Modelers"

Pre-Fab Kit J-7-F: Assembled Box J-7-F:
\$12.95 (add 35c P.P.) **\$21.95**

ask your dealer or order direct

BROADFIELD AIR-MODELS
ASHLAND, MASS.

no A.M.A. to provide the incentive for developing the future Taurus kits, the proportional radio equipment, the engines, components, and materials that the contest flier demands and everybody else uses!

Let's suppose, for the moment, that you are interested in R/C competition, and that your goal is to someday compete in F.A.I. world competition on the U. S. R/C Team. How do you do it?

First, you join the Academy of Model Aeronautics. Only members of AMA are eligible to represent the U. S. at the R/C World Championship. This is because the championships are operated under the regulations of the FAI — that's the Federation Aeronautique Internationale, world governing body for all aviation records and world championships, including air-modeling.

The FAI recognizes only one organization in each country as the official representative of that country; the organization is called the National Aero Club. In the U. S., our national aero club is the National Aeronautics Association and that title is recognized by an official charter from Congress.

The N.A.A. directly governs all U. S. full scale aircraft records but delegates the jurisdiction for other branches of FAI activity to the various divisions of NAA. Thus, all U. S. parachute records and competitions come under the NAA division known as the Parachute Club of America; likewise, soaring is under the Soaring Society of America; and all air-modeling is under the Academy of Model Aeronautics.

The Academy in the 30's was an integral part of the NAA. It now is an independent division of NAA and is, by written agreement, designated as the U. S. governing body for model aviation with jurisdiction over national and international model aviation activities in this country.

Now, with AMA license in hand, you are eligible to participate in any or all of the various team selection programs operated under the AMA President's jurisdiction and as detailed in the AMA membership publication. In recent years, the R/C teams have been made up of the top three fliers in the R/C Pattern event at AMA's National Model Airplane Championships for the year involved. This may change in future years, but basically it is a matter of determining in rugged AMA competition the top three R/C fliers in the team selection year.

NAA has for many years provided air transportation across the Atlantic at no charge to the team members. There is no guarantee that this transportation will always be provided and there have been some anxious times when the transportation availability has been in serious doubt. But NAA has come through in all four years of R/C team travel to date

and is expected to be able to continue this aid. If NAA transportation should become unavailable, it is expected that AMA would put on a campaign for contributions to help provide for commercial airline fare.

Transportation between the team member's home town and the point of transatlantic flight departure is usually paid for by the team member himself with some compensation in the form of contributions from R/C fliers and clubs. Future team selection programs may provide additional support for such "in-board" travel by special entry fees.

That travel from the point where the transatlantic flight ends to the world championship site (and back) is usually paid for by AMA out of a special budget from general AMA income. How much AMA is able to pay depends upon how much R/C FAI interest is involved. To date, such overseas costs have not exceeded budget limits so that travel costs in Europe have not been borne by team members except when they choose a route or class more expensive than the economy fare covered by AMA — the difference is then paid by the team member.

AMA's FAI budget has also paid the FAI entry fees required by the country hosting the championships — from \$25 to \$40 per team member. Such entry fees usually include lodging and meals provided by the host country.

All other costs are borne by the team members, including meals and lodging away from the world championships, sightseeing, shots (sometimes available without charge at military dispensaries), etc. Fuel and shipment of same is usually provided by hobby industry support — in 1965 K & B was the fuel sponsor.

The main difference between the World Championships and our own Nationals is that the World Champs are much tougher. Three consecutive good flights are a must — one poor flight is prohibitive so far as top scoring goes. The '65 team concedes that we'll need a tougher selection system to pick our next team — that even though we won again it was by a very thin edge. Only 54 points out of some 20,000! About two-tenths of a percent difference between first and second!

Think you're good enough? Maybe not. Perhaps you "couldn't care less" about competition, much less competing on the U. S. team. But, wherever your interests lie, please . . . **please care enough** to join the Academy of Model Aeronautics. We're at those crossroads **right now**, and **you** are in a position to decide the future of this hobby. My wife, Sally, is an A.M.A. member even though her active participation in R/C is simply to pick up the pieces and help carry them home. My kid is an A.M.A.

(Continued on Page 72)

An RCM Technical Feature

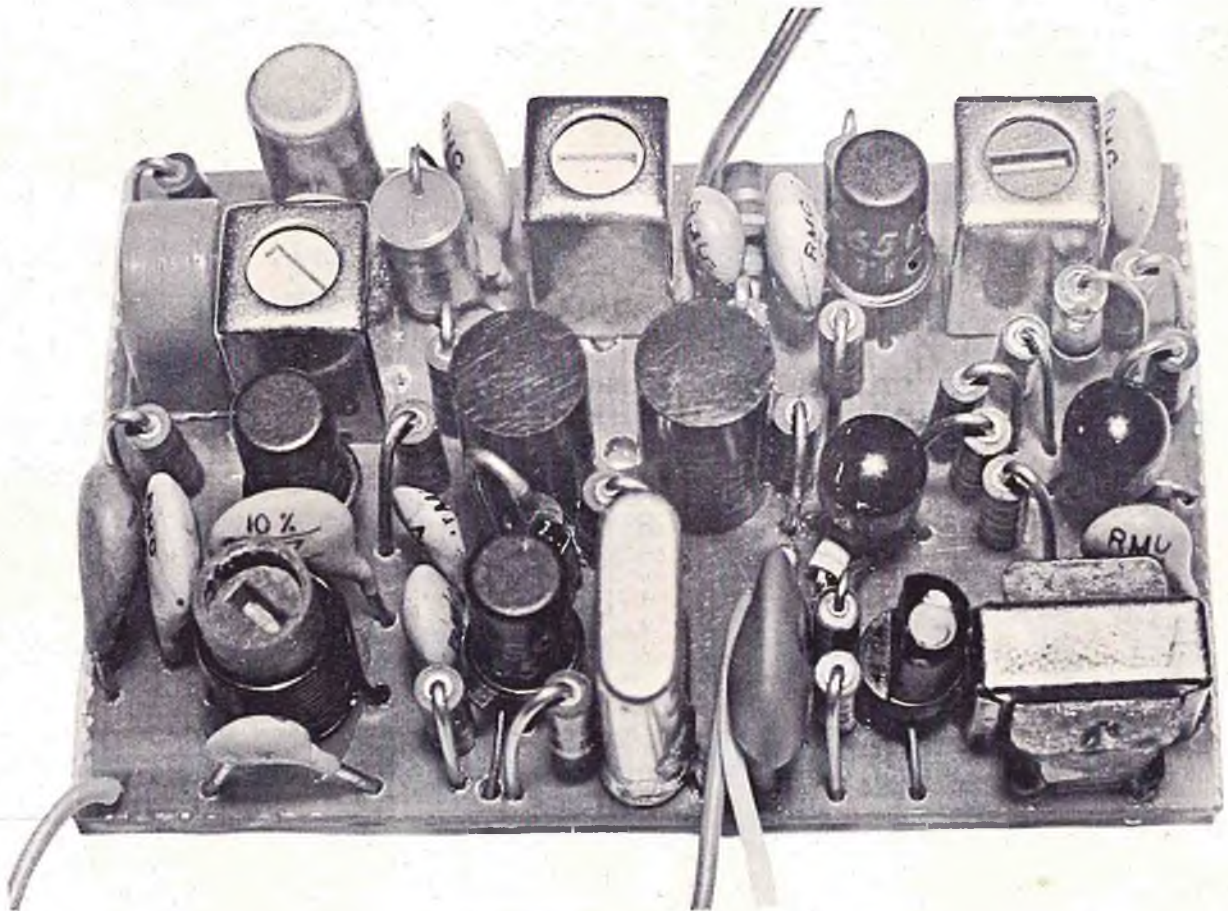
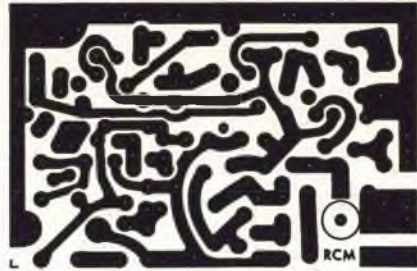

ED THOMPSON
RCM Contributing Technical Editor

RCM DIGITRIO

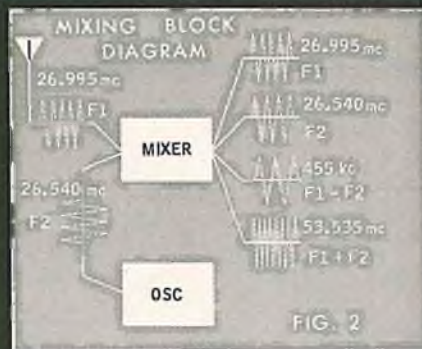

Part IV: Constructing the Digitrio Receiver

PREFACE

JUDGING from the overwhelming amount of mail and phone calls we have received from virtually every corner of the United States, as well as overseas, we can safely assume that there are well in excess of a thousand RCM Digitrio's presently under construction. Many of our readers have asked for advance construction details, as well as information as to who is kitting the system. Unfortunately, this widespread enthusiasm is the very reason why we cannot meet these reader demands for advance material. In the way of explanation, since the reader response is so great, all of my own available time is being spent re-writing the articles around new packaging, making the articles themselves more complete, and adding artwork to assist you in construction. And, since reproduction of the system itself is of paramount consideration, Don and Chuck are each building new systems around these changes in order to check the validity of the articles prior to publication. This, plus constant proof-reading of the manuscript and artwork, has placed the RCM staff on a very tight schedule. I hope that you technicians can appreciate this thorough-

ness and realize the benefits to the less experienced constructor.

The original system was built entirely with diverted "grocery money," and lacked the advantages of extended research and development that only money can buy. Electronically, very few changes were necessary since the original prototype performed to perfection. I sent it to Don Dewey for evaluation as a prelude to a possible construction series. Based upon Don's evaluation, and subsequent acceptance, I decided to repack the system more attractively. Don not only accepted the articles, but agreed to help defray the repackaging expenses. So, back to the drawing board I went, this time with the assurance that what I could put on paper mechanically, Chuck Waas (Don's untiring workhorse), could build!

As you can see, the entire project was snowballing. However, with all the assurance and help received to this point, one thing still "bugged" me. Servos! Where was I going to find a suitable servo-mechanism that would not only meet the system requirements, but overcome the horrifying thought of having to scratch-build these units? Just about this time in the overall scheme of things, Jack Port of Control-

aire expressed the desire to kit the system, and offered his new proportional servo for the Digitrio. That did it, and off we went! With all systems go, the repackaged unit was completed less than six weeks.

The weekend the repackaging process was finished, I phoned Don and told him to put on the coffee, as I was coming over. (Ed's note: The "coming over" consisted of driving approximately 700 miles from Glendale, Arizona, to Sierra Madre, California!) I installed the equipment in a newly completed, and modified Falcon 56, built by Rusty Fried, and headed for California. After a day's work getting everything ready, we sneaked into Don's favorite flying site (after the guard went home) and put in the first test flights on the repackaged system. These were completely successful, and we were by the first hurdle.

The next day, Chuck and I visited Don Mathes and Doug "Mumbles" Spreng at Micro-Avionics, Inc. After trying unsuccessfully to dislodge any secrets about their new system, we decided to go flying. And since I had the only airplane ready to fly, I had the feeling that my system was going to be "nit-picked" to pieces. One consolation was that I couldn't think of any two individuals more qualified to do it! On the way to the flying site, Doug kept mumbling something about - "If it will fly there, it will fly anywhere!" When we arrived, the full impact of his statement was evident. The flying site looked like a tennis court with the surrounding fence lowered to five feet! It was bounded by a skeet range and pistol range (I still think I was shot at!) towering radio antennae, and vehicles with C.B. rigs constantly running up the street. I think I heard some of them talking into their mikes about some "kids" flying toy airplanes.

Doug won the toss to fly - mainly because everyone else was chicken. After a masterful flight that left Don Mathes in a prone position most of the time (he remembered the time that Doug hit himself on a low pass), Doug,

Page 19, Top: Full size receiver P.C. Board ready for photographer. Left: Completed Digitrio Receiver for construction reference.

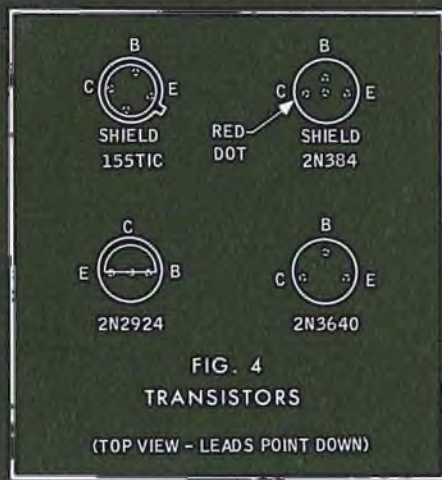
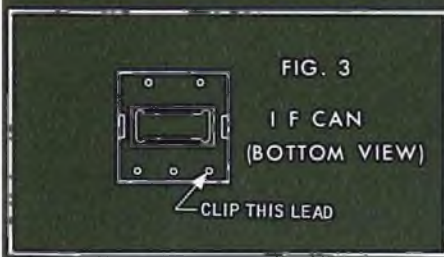

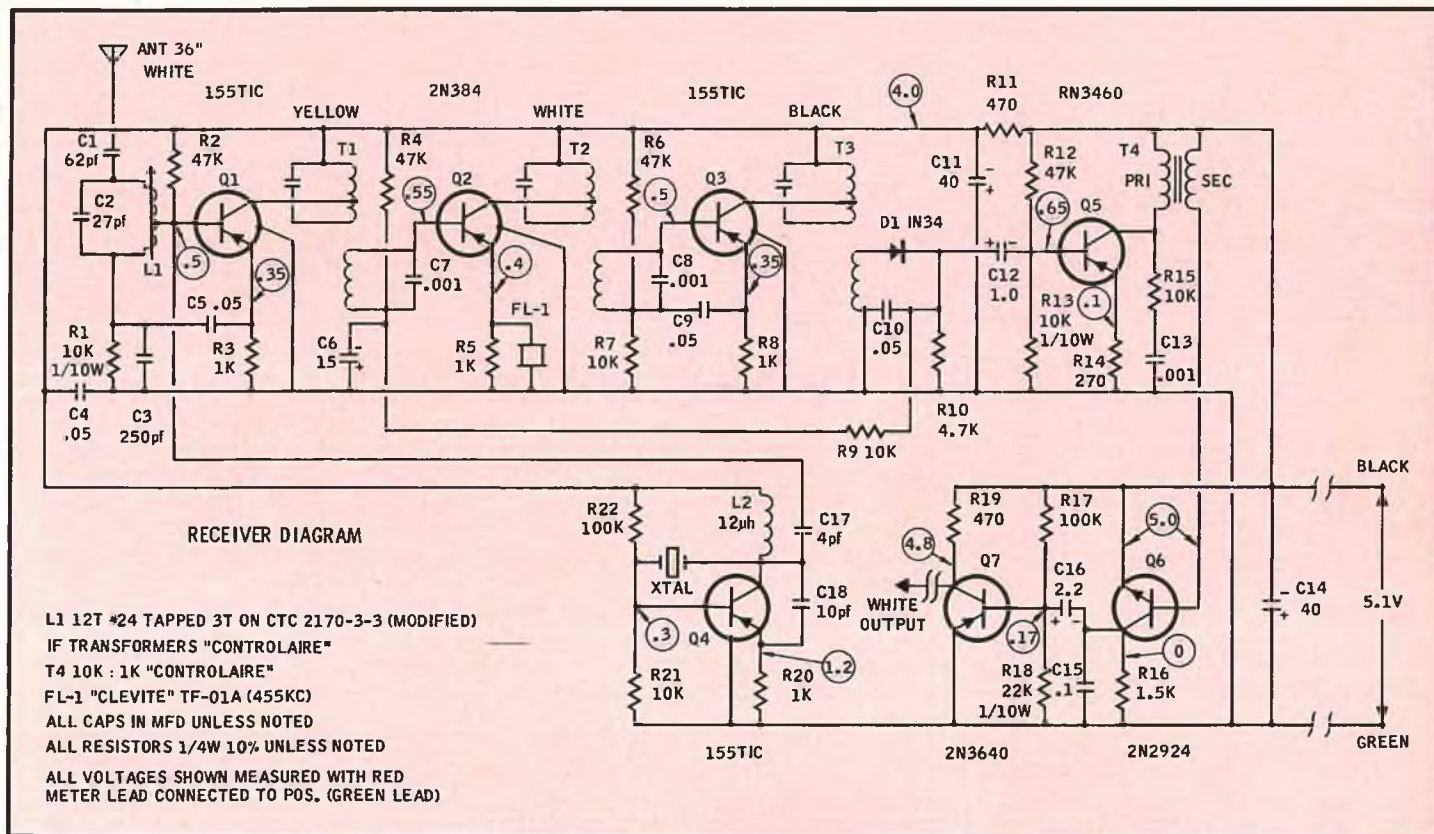

RCM DIGITRIO

much to my surprise, began talking coherently! This was the tip-off! The Digitrio was destined to become successful. What's more, Doug continued to talk coherently for a full fifteen minutes, which I believe, is a record.

I left the plane with Don Dewey for two weeks, during which time Bill O'Brien flew it for approximately sixty flights without mishap. This included passing the transmitter around to all interested bystanders to try. Upon return of the system, I added another 125 flights without any form of problem or mishap.

And that's the Digitrio, as it stands today. I hope you will be patient until the conclusion of the series, and understand our reasons for having to decline to furnish advance information. We're doing our best, and feel that this additional effort on the part of many individuals will provide you with a proportional system that will render many years of reliable service.

For the advanced technicians, the scope pictures accompanying this article were sent in by Dave Holmes of Grafton, Virginia. Dave's Digitrio transmitter is operating on 6 meters, and he passed on the following infor-



mation for the hams wanting to make this conversion:

1. Pri L2 is six turns #20 on CTC 2175-4-3 ceramic form.
2. Sec L2 is 2T hook-up wire.
3. L5 is 3T #14.
4. C2 is 10 PF.
5. C6 is 39 PF.
6. C7 is 22 PF.
7. C8 is 7-45 PF.
8. L1 is 10 to 12 uh.

Dave says his transmitter puts out about 1/2 watt.

I will write a complete 50 MC conversion article for publication as soon as time permits but this information should give the more advanced technicians a starting point.

One major manufacturer is kitting the system, the only "designer approved" kit, another company is providing the system ready-to-fly, and several more are offering the printed circuit boards ready for wiring. However you decide to build it, we hope you will do just that—build it. And in so doing, increase your own enjoyment of this hobby by expanding your knowledge and abilities.

The RCM Digitrio was designed for you.

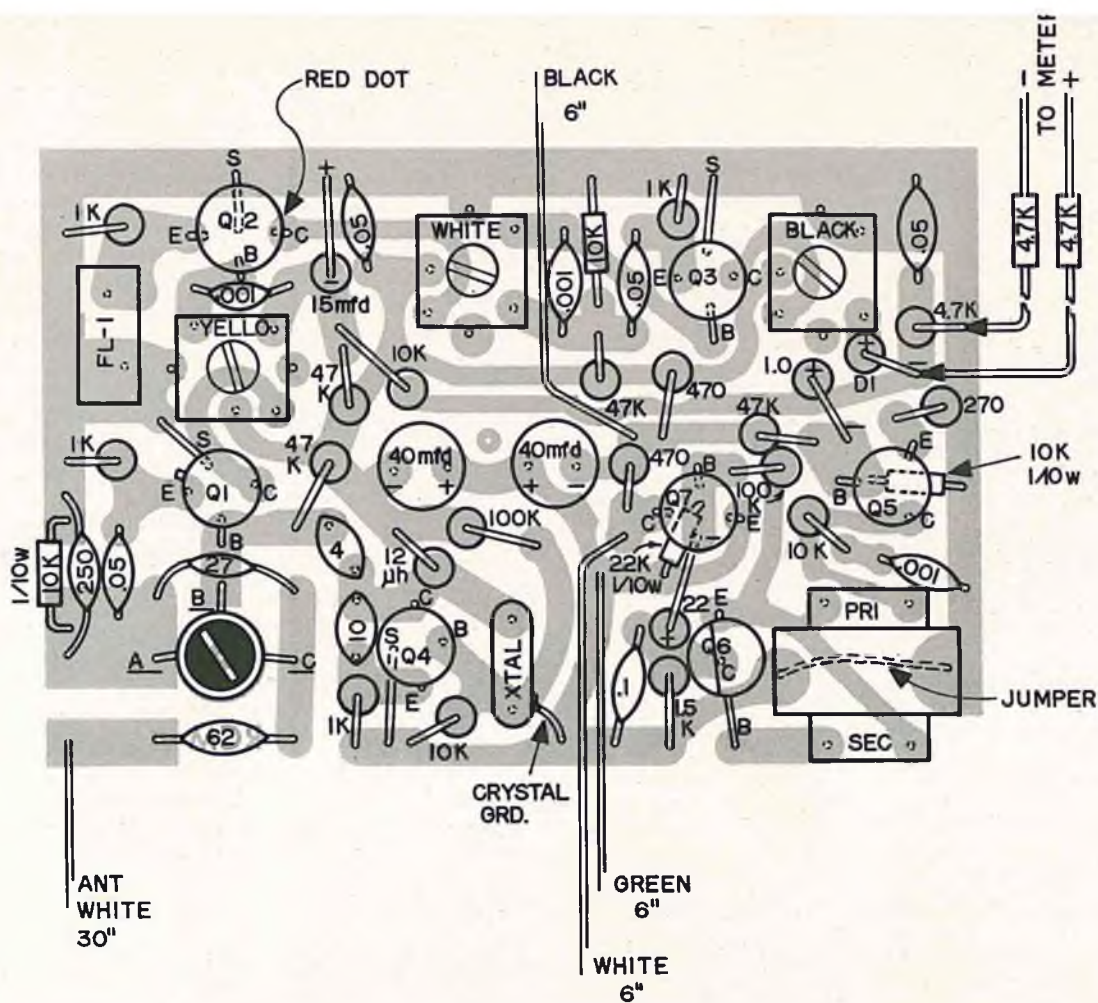

RCM DIGITRIO

THEORY OF RECEIVER

Since receivers fall into the "done to death" category I won't waste much of your time on the more elementary features of superhets. Instead of cluttering up the page with sporadic theory let's take a signal through and apply theory as we go.

Assume we are transmitting our pulse trains at 26.995 MCS, our signal is impressed on the antenna and fed to the tuned circuit (L1 and C2) through C1. This tuned circuit is tuned to 26.995 and will basically reject all others. Since our antenna is short at this frequency it presents a high impedance at the connecting point (top end of tuned circuit). This is proper since a parallel-tuned circuit at resonance presents maximum impedance. However we must transfer this signal to a relatively low impedance (base of Q1. L1 is tapped three turns from the "cold" end to effect an impedance transformation and "suck" our signal out of the tuned circuit without destroying its "selective" properties. C3 supplies the RF ground for the bottom end of the tuned circuit. C5 is connected from the "cold" end of the tuned circuit to the emitter of Q1 to

complete the signal path and prevent degeneration of the signal by R3. R3 is used for temperature stabilization of the stage. R1 and R2 provide forward bias and establish the DC operating point of the stage. Let's stop there for now until we cover the oscillator.

Q4 is the oscillator and operates as a series mode crystal oscillator at 26.540 MCS. R21 and R22 provide forward bias for this stage. R20 provides temperature compensation and emitter isolation from ground. L2 is an RFC and provides collector voltage while maintaining a high impedance to RF at that point. C18 increases the collector-emitter capacitance to allow easier oscillation.

Assume we have just applied voltage to the circuit and Q4 starts conducting. This rapid conduction develops a voltage across L2. This instantaneous conduction will be a sharp rise in current rich in harmonics. At some point the multi-frequency characteristics of this sharp wave front will correspond to the series resonant frequency of the crystal. Since the crystal impedance is low at its series resonant frequency and there is a 180 degree phase shift across it, regeneration will occur. The crystal

impedance rises sharply on each side of its series resonant frequency so oscillation will occur only at the series resonant frequency of the crystal. As mentioned earlier, C18 allows easier oscillation. It provides regenerative feedback to the emitter and its value is high enough to swamp the inherent collector-emitter capacitance and make oscillation relatively independent of transistor parameters. C17 couples the RF voltage to the base of Q1. The fact that we have two paths of regeneration, the circuit is fairly tolerant of transistor characteristics, and is lightly loaded, makes it a very reliable circuit. The next step is to mix the oscillator frequency with the incoming signal, and I'll try to make it as painless as possible!

To get successful mixing action we must operate Q1 in the non-linear portion of its dynamic transfer characteristic curve or drive it hard enough to exceed the linear portion of its curve. In this case, Q1 is biased in the low current portion of this curve. (Close to the non-linear knee). The oscillator drive then automatically exceeds the linear operating point, and mixing, as well as amplification, occurs. The out-

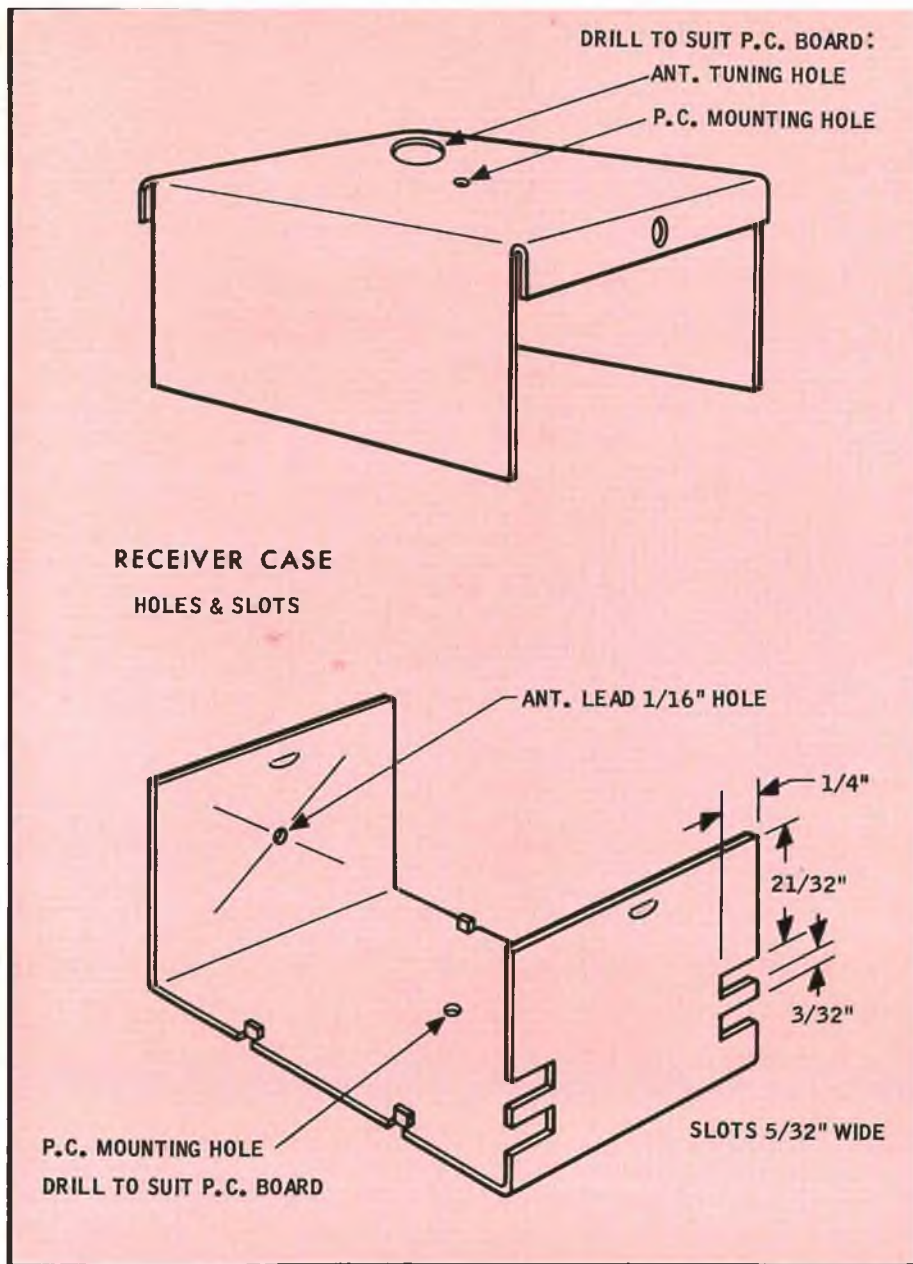

RECEIVER CASE

HOLES & SLOTS

put of the mixer Q1 contains four frequencies, as follows:

1. Original signal input 26.995 MCS.
2. Oscillator input 26.540.
3. The difference between the two inputs 26.995 minus 26.540 = 455 KC.
4. The sum of the two inputs 26.995 plus 26.540 = 53.535 MCS. (See figure 2.)

T1 is tuned to 455 KC and will pass this frequency on to Q2 while rejecting the other three. This signal will be a replica of our incoming signal, differing only in frequency. The selection of 26.540 MC for our crystal should now be obvious. If your receiver oscillator is operating 455 KC below the incoming signal from the transmitter the same relationship applies, regardless of your transmitting frequency. Another way would be to use a crystal 455 KC higher than the incoming frequency (while you have your pencil handy figure it out).

T1's primary is tapped to provide proper impedance matching to Q1's collector and the primary-secondary turns ratio provides interstage impedance matching. R4, R9 and R10 provide forward bias for this first IF stage. R9 and R10 are used as the AVC voltage divider as well. C6 is used as signal ground for T1's secondary as well as an AVC filter. R5 provides temperature compensation and is bypassed at 455 KC by FL1.

FL1 is a ceramic filter that has series resonant properties at 455 KC. At this series resonant frequency it exhibits very low impedance and effectively bypasses R5. It has a pass band of four to seven percent. At frequencies outside its bandpass it presents a high impedance, and degeneration occurs. The use of FL1 increases selectivity sufficiently so as to pay for itself. C7 loads the secondary of T1 and helps minimize signal ringing. It also seems to have a resonating effect and actually increases stage gain. Our signal is

amplified by this first IF stage and is coupled through T2 to the next (second IF) stage. Let's proceed with the signal and cover AVC later.

T2 is also tuned to 455 KC and the signal is further amplified by Q3. R6 and R7 provide forward bias for this stage while R8 is used for temperature compensation. C9 couples the "cold" end of T2 to the emitter to complete the signal path without degeneration. C8 is used the same as C7. T3 is again tuned to 455 KC and couples the signal to the detector diode (D1). D1 rectifies the IF signal and passes only the positive half. C10 removes the 455 KC signal component, by-passing it to ground.

So far we have processed our signal into a train of audio frequency pulses. Look again at R4, R9 and R10. These resistors establish the negative bias voltage for Q2. They also forward bias D1. The rectified positive IF signal from D1 will cause the junction of R9 and R10 to swing in a positive direction. This will in turn cause the negative bias on Q2 to decrease thereby controlling the gain of that stage. C6 is used to filter the signal excursions into a smooth DC control voltage. This AVC (automatic volume control) is necessary to prevent signal overloading of the IF stages and provide a relatively constant signal for the rest of the receiver. Since this AVC voltage varies with signal strength we can use it to peak up the receiver.

C12 couples the detected signal to Q5 (first audio). R12 and R13 provide forward bias and R14 is used for temperature stabilization. R14 is purposely not by-passed so that the stage is slightly degenerative. The signal is amplified and coupled to Q6 via T4. R15 and C13 are used to smooth the negative going signal transitions which otherwise would be sharp ringing pulses. Q6 has no forward bias and conducts when the signal level exceeds approximately .3 volts. This lack of bias prevents low level trash and/or electrical noise from triggering the rest of the circuits. When Q6 conducts, the voltage at the top of R16 goes negative, driving Q7 into conduction. C15 is a noise filter and is quite effective. C16 is used as a coupling capacitor between Q6 and Q7. R17 and R18 forward bias Q7. Q7 develops its signal across R19 which goes directly to the decoder. The last two stages are over-driven to shape/square the pulses. C4, C11, C14 and R11 are all used for filtering and decoupling.

I have deliberately omitted references to waveforms to minimize the confusion factor. I would suggest that you reread the foregoing again, only this time include the waveforms with the text. As you can see, all the waveforms are smooth with no "brute force"

characteristics. This allows for non-critical tuneup and reliability. Also there are no ringing tendencies or any form of instability. A word of warning: **Don't** indiscriminately substitute parts values or try to improve the circuit unless you thoroughly understand all aspects of the circuits and are willing to take the consequences! Don't be led down the primrose path by those who tell you that range will be increased by reducing the value of R11. It's much more complicated than that! You might get more noise through the IF's but it could be mostly noise generated by the IF's themselves. As you follow the waveforms and block diagram (figure 1) you will note how the signal progresses through the receiver until we get to Q7's collector. This signal going to the decoder is a good replica of the signal at Q10's collector in the transmitter. These pulses will precisely follow stick movements at the transmitter. Let's get this thing built so we can continue.

MAKING THE RECEIVER CASE

The receiver case is a standard LMB #SE-MOO aluminum box. The drawing shows cutouts and holes necessary for packaging the receiver/decoder. If you intend to have the case anodized or painted use emery cloth and steel wool to polish it as described in the transmitter article.

PREPARING THE P.C. BOARD

Whether you make your board or buy it with a kit you should prepare it as follows:

- () Make sure it fits the case. The receiver board fits into the half of the case with the lip bent up on each end. File the edges of the board until it fits properly. Make sure there is adequate clearance at the ends so the box will go together smoothly.
- () Locate the mounting hole and drill it with the P.C. board and insulating sheet in place, conductor side down on the P.C. board. Use a drill size somewhat smaller than the mounting screw diameter so it can tap itself into the board.
- () Find the center of the coil form hole and drill it as above with the same drill.
- () Remove the board and enlarge the mounting hole in the case to match the diameter of the mounting screw. Enlarge the coil form hole with a #9 drill. Enlarge the coil form hole in the insulating sheet to permit tuning.
- () Drill all holes in the P.C. board with a #60 drill if they are not already drilled.
- () Take all components with leads/lugs larger than #60 and drill the board to fit them. The IF transformers will have to be

modified as follows before fitting: stand the IF transformers on their tops so that the leads/lugs are pointing upwards. Position the transformers so that the leads are arranged as in figure 3. Clip the lower right lead off flush with the can on all three transformers.

- () We are only going to use the top portion of the coil form and throw away the end with the lugs. Remove the tuning slug and cut the coil form $\frac{1}{16}$ " from the top. Enlarge the coil form hole in the PC board to slightly less than required (#9 drill) and finish up with a round file for a press fit.
- () Place a 6" square piece of fine emery cloth on a flat surface and "sand" the copper side of the board to remove all "burrs."
- () Clean the copper side with scouring powder until it is bright and shiny.
- () Insert the coil form until it is flush with the opposite side of board and epoxy it into place.

WIRING THE P.C. BOARD

Refer to construction overlay and photographs to wind turns on L1.

- () Scrape the end of a piece of #24 enameled wire (approximately 12" long), insert, and solder it in Hole "A". Bend the wire over flat against the P.C. board and wind three turns in a clockwise direction. Cut, scrape and insert the other end in Hole "B". Scrape one end of the remaining wire and insert it also in Hole "B" and solder. (You may have to enlarge Hole "B" slightly to accommodate both pieces of wire.) Continue winding, in a clockwise direction for nine more turns. Cut, scrape, and solder the end of the wire in Hole "C." When you are through you should have a close-wound/twelve-turn coil tapped at three turns. Inspect the coil closely for shorted turns. If you are not satisfied with the coil, either mechanically or electrically, simply rewind it. Wire is cheap, and quality at this stage of the game will pay off.
- () Mount the three IF transformers, observing the color coding of the cores (see schematic and construction overlay.)
- () The AF transformer will probably have a corrosion-resistant agent on the metal mounting lugs. This should be removed by filing and tinning the lugs thoroughly before mounting. The transformer frame acts as a jumper and must have a good electrical connection. An external jumper across the top of the transformer soldered directly to the P.C. board will insure a good connection. Make

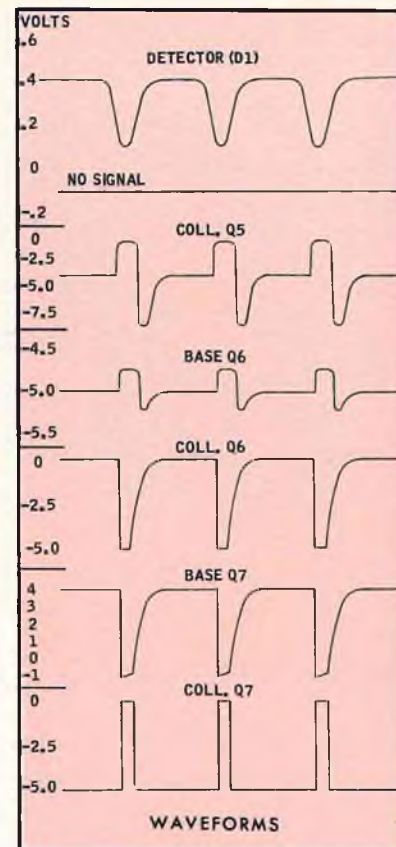

sure the primary and secondary are as shown on the construction overlay.

- () Mount the crystal flush against the board. Note the wire labeled "crystal ground" on the construction overlay. When you solder this wire make sure you do not "unseal" the crystal.
- () Solder FL-1 into place by bending the lugs over and avoid overheating.
- () Mount the two 40 MFD. filter capacitors, observing polarity.
- () Mount all resistors as shown on the overlay. Do not forget R1 (10K 1/10W) under the 250 PF cap (C3). Use only sufficient heat on the 1/10W resistors to insure a good connection, as they are prone to change value when overheated.
- () Mount all disc capacitors making sure none of them "overhang" the edges of the board.
- () Mount D1, observing polarity.
- () Mount the remaining capacitors, observing polarity.
- () Mount L2.
- () Starting with Q1, install all transistors (see figure 4 for lead identification.)
- () Install antenna and connecting wires as to length and color shown.
- () Clip all soldered leads off to the board, and using a 1" wide "fine" file, file the conductor side of the board until the solder mounds are "flatted" and about $\frac{1}{32}$ " to $\frac{1}{64}$ " high. Finish with emery cloth

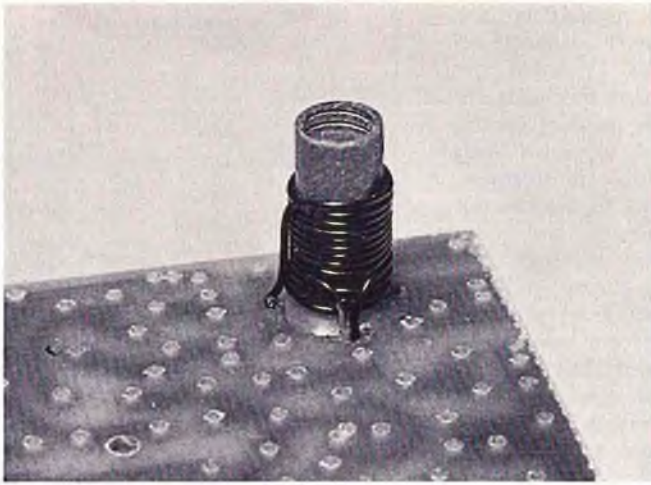

This photo clearly shows the winding and placement of leads for L1. First step in assembling receiver. Coil form is epoxied to P.C. Board — we used Hobby epoxy Glue.

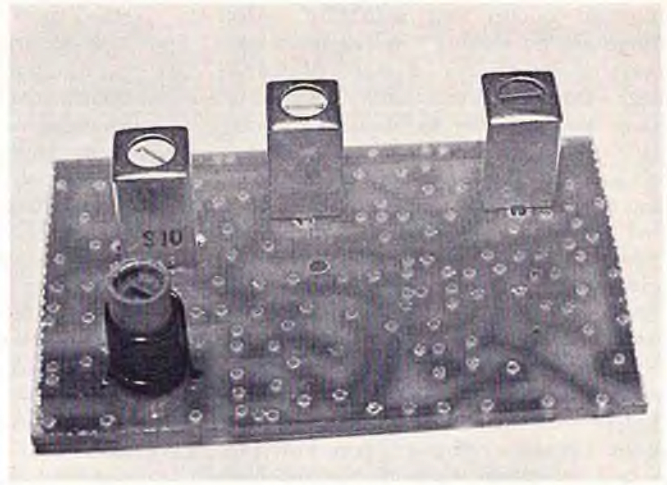
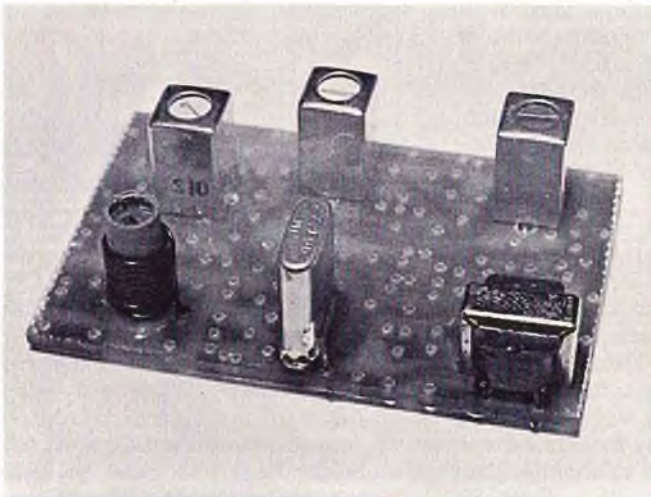

Photo showing installation of T1, T2, T3, World Engines 455 KC IF Transformers. Watch color coding. Holes for mounting lugs must be enlarged for snug fit.



This view shows installation of crystal and T4, 10K:1K Audio Transformer. Note grounding wire soldered to side of crystal can. Exercise caution so as not to destroy seal on crystal.

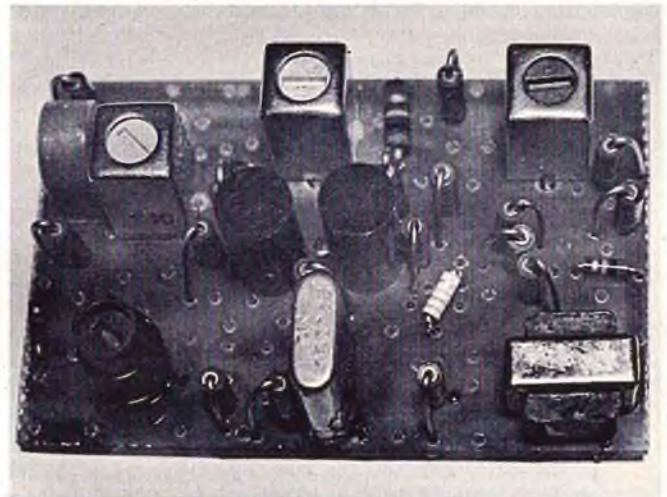
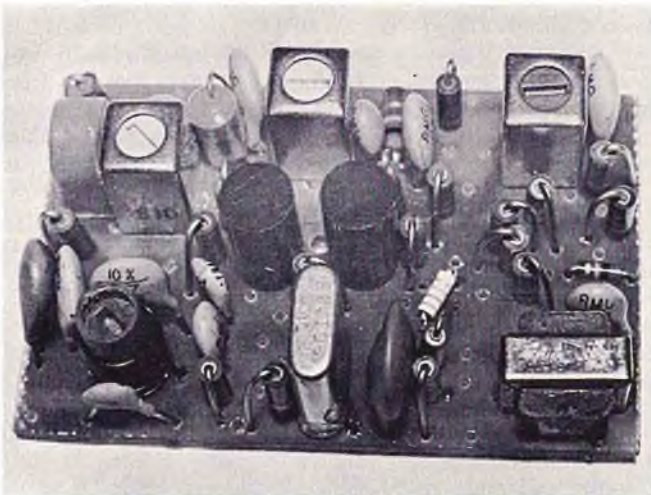
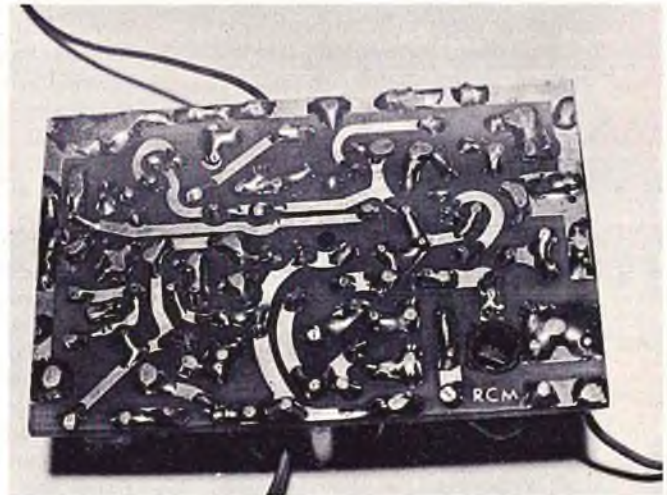

Illustration of placement of resistors R1 through R22. Note FL-1 Clevite transfilter upper left hand corner. Holes must be enlarged to accommodate leads. Be sure to observe polarity on C11 and C14, center of photo.



In this photo, all capacitors are in place, C1 through C18. Observe polarities. Observe proper polarity on C6, C12, and C16, axial lead electrolytics.



Trim all excess leads and solder points on underside of P.C. Board. Clean with dope thinner and a stiff brush. Bevel edges of board with extremely fine toothed file so that neither solder or copper leads can make contact with side of case.

on a flat surface. Visually check all connections and resolder any in question.

- () Bevel the bottom side of the P.C. board on all sides with the same file to prevent electrical contact of the lands with the case.
- () Clean the board of all solder resin with a stiff brush and Acetone or Dope Thinner. A toothbrush can be used here if you work fast inasmuch as Acetone will dissolve the bristles and leave a slight non-harmful residue.

PRELIMINARY CHECK OF RECEIVER

- () Measure the resistance between the black (negative) and green (positive) wires. (Observe meter polarity.) Your meter should indicate approximately 6K ohms. If it is much less, check the board for solder bridges between lands, or improperly mounted components.
- () If the resistance check was good we can now apply five volts (4 nicads in series). Place your meter (on milliamp scale) in series with the black lead from the receiver. The black meter lead goes to the battery pack negative and the red meter lead goes to the black receiver lead. Connect the green lead from the receiver to the positive side of the battery pack. Your meter should read approximately 4 M.A. If not, recheck the P.C. board for mistakes.
- () Measure voltages of the different stages as shown on the schematic (voltages are encircled). They should all be within 10 to 20% depending on the meter you use. I used a 20,000 ohms per volt multimeter for all measurements. If all is well so far, and your transmitter is working, you can tune the receiver and make some range checks.
- () Mount the receiver board in the case (don't forget the insulating sheet).
- () Temporarily solder two 4.7 to 10K resistors at points X and Y on the overlay.
- () Place the receiver on a non-metallic surface and extend the antenna.
- () Place your meter on the lowest voltage range and connect the red lead to the other end of the resistor going to point Y. Connect the black meter lead to the resistor going to point X.
- () Connect the 5V battery pack to the receiver. Black receiver lead to negative and green receiver lead to positive. The meter should read slightly negative (backwards). This is proper and no cause for alarm.
- () Collapse the transmitter antenna,

PARTS LIST FOR RECEIVER

REFERENCE NUMBER	DESCRIPTION	MANUFACTURER OR SOURCE	MANUFACTURERS' NUMBER
C1	62 PF	RMC	SM-62
C2	27 "	"	SM-27
C3	250 "	CRL	DD 251
C4	.05	RMC	M12 .05 MF
C5	.05	RMC	"
C6	15 MFD. Elec. (Axial Leads)	World Engines	CL-156
C7	.001	RMC	SM .001MF
C8	.001	RMC	"
C9	.05	RMC	M12 .05 MF
C10	.05	RMC	"
C11	40 MFD. Elec. @6V (P.C. Leads)	World Engines	FPC-40-B-O
C12	1 MFD. Elec. (Axial Leads)	"	CT-105
C13	.001	RMC	SM .001 MF
C14	40 MFD. Elec. @6V (P.C. Leads)	World Engines	FPC-40-B-O
C15	.1 MFD.	CRL	UK10-104
C16	2.2 MFD. Elec. (Axial Leads)	World Engines	CT-225
C17	4 PF	RMC	SM-4
C18	10 "	"	SM-10
D1	Germanium Diode	Ohmite	1N34
FL-1	Transfilter	Clevite	TF-01A (455 KC)
L1	12T #24 Tapped 3 Turns on C.T.C.	Form 2170-3-3 Modified.	
L2	12 uh RFC Choke	World Engines	ES755
Q1	155T1C	" "	155T1C
Q2	2N384	RCA	2N384
Q3	155T1C	World Engines	155T1C
Q4	155T1C	" "	"
Q5	2N3640	Fairchild	2N3640
Q6	2N2924	G.E.	2N2924
Q7	2N3640	Fairchild	2N3640
R1	10K 1/10W	Ohmite	LIDSM
R2	47K 1/4W	"	"
R3	1K "	"	"
R4	47K "	"	"
R5	1K "	"	"
R6	47K "	"	"
R7	10K "	"	"
R8	1K "	"	"
R9	10K "	"	"
R10	4.7K "	"	"
R11	470 "	"	"
R12	47K "	"	"
R13	10K 1/10W	"	"
R14	270 1/4W	"	"
R15	10K "	"	"
R16	1.5K "	"	"
R17	100K "	"	"
R18	22K 1/10W	"	"
R19	470 1/4W	"	"
R20	1K "	"	"
R21	10K "	"	"
R22	100K "	"	"
T1	455 KC Input IF Transformer (Yellow Dot)	World Engines	---
T2	455 KC Interstage IF Transformer (White Dot)	" "	---
T3	455 KC Output IF Transformer (Black Dot)	" "	---
T4	10K: 1K Audio Transformer	" "	---
Crystal	Frequency Desired	" "	---
---	Receiver Case	LMB	SL-MOO
---	2 1/8" x 1 3/8" Piece of 1/64" Insulation Sheet	World Engines	---
---	Sheet Metal Screw #2 or 3 x 1/4"	" "	---
---	P.C. Board	" "	---
---	#24 Enameled Wire (24")	---	---

turn it on and place it about ten feet from the receiver.

- () Adjust the IF transformer and antenna cores for maximum reading on meter (meter should be reading in the proper direction now),
- () Increase the distance between transmitter and receiver as you

tune so that final tuning results in a very low meter reading when the receiver is peaked (this prevents AVC overload and allows for sharper tuning.) You can remove the transmitter antenna for final tuning or have a friend walk down the street with the transmit-

- ter.
- () Borrow a set of high impedance headsets from your ham friend and connect them between the white and green receiver wires. Use a .05 MFD. capacitor in series with the white lead. You should hear a "buzzing" noise when the transmitter is turned on.
 - () Borrow a yardstick from your understanding wife and tape the receiver and battery pack at one end, extend the antenna lead up the stick and secure it at the top with tape. Connect the headset, and with your buddy holding the transmitter, start walking across the "boon-docks." Your range should exceed ¼ mile on the ground. Take your tuning wand along, and when the signal gets "raggedy," peak up the antenna core. Do not adjust the IF's as they should be adjusted with the meter. Ground range will depend on terrain and system tuning. All of my systems to date were still going strong at 3/5 of a mile over a cement runway.

PARTS LIST FOR RECEIVER

Since size is an important factor for the receiver parts, substitution will require careful selection. Every part in the receiver should be easily obtained from your parts dealers except for the parts marked "World Engines" in the "Manufacturer or Source" column. Most parts' houses have catalogs for the different component manufacturers which they give free to buyers. Sizes are generally listed and you can cross reference parts to those they carry in stock.

I do not recommend substitution of any parts' values in the receiver unless you thoroughly understand the circuitry and can analyze the circuit parameters with proper test equipment.

ERRATA TO ARTICLE II TRANSMITTER

1. Figure 2
 - a. Top waveform should be marked 6.5 MS not 6.5 us.
 - b. Second waveform should be marked B not B.
 - c. Third waveform should be marked B not B.
2. Schematic
 - a. R5 should be 330 not 300.
 - b. Wire pointing downward from bottom half of off-on switch should be marked "Y."
 - c. Wire connecting J1 and J2 should be marked "black."
3. Construction Overlay

The .05 capacitor below L3 and L4 is not shown on schematic or listed in parts list. Draw it in on schematic in parallel with C23 and list it as C25 in parts list. It is a Centralab type UK20-503.

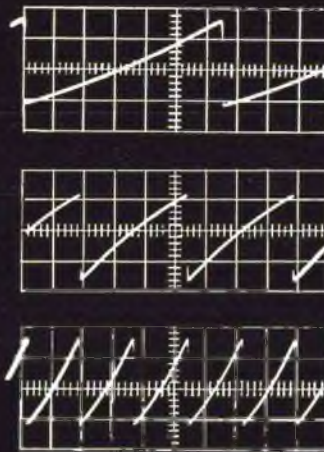

Output of pulse generator taken at point A showing effect of varying R23 and R30.

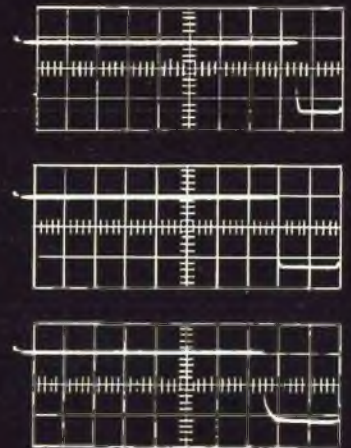

Collector of Q6-500 us/div. 2 volts/div. showing effect of stick movement.

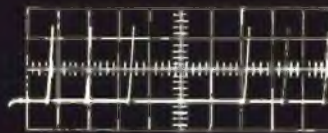

Base of Q10 1ms/div. 2 volts/div.

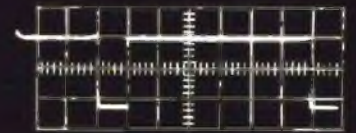

Collector of Q10. 200 us/div 2 volts/div.

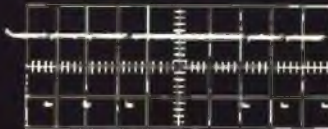

Collector of Q10. 1ms/div. 2 volts/div.



Collector of Q11. 1ms/div. 2 volts/div.



Collector of Q11. 200 us/div. 2 volts/div.

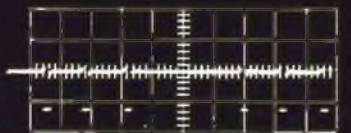

Base of Q11. 1ms/div. .5 volts/div.

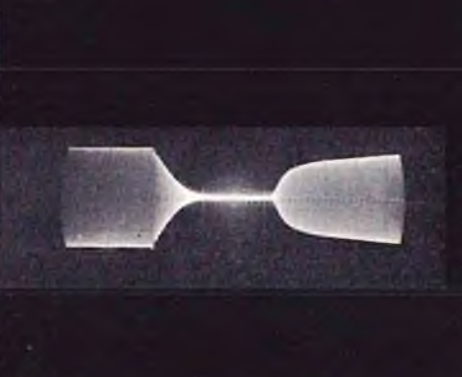
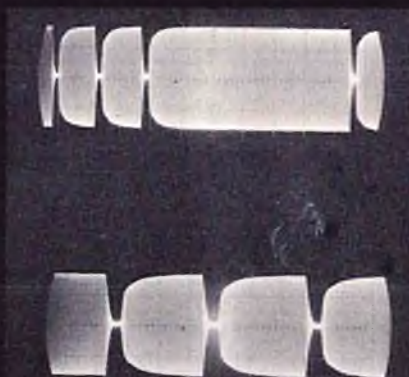

RF output at various settings of time base.

COMING NEXT MONTH: PART V OF THE
RCM DIGITRIO
CONSTRUCTING THE DECODER

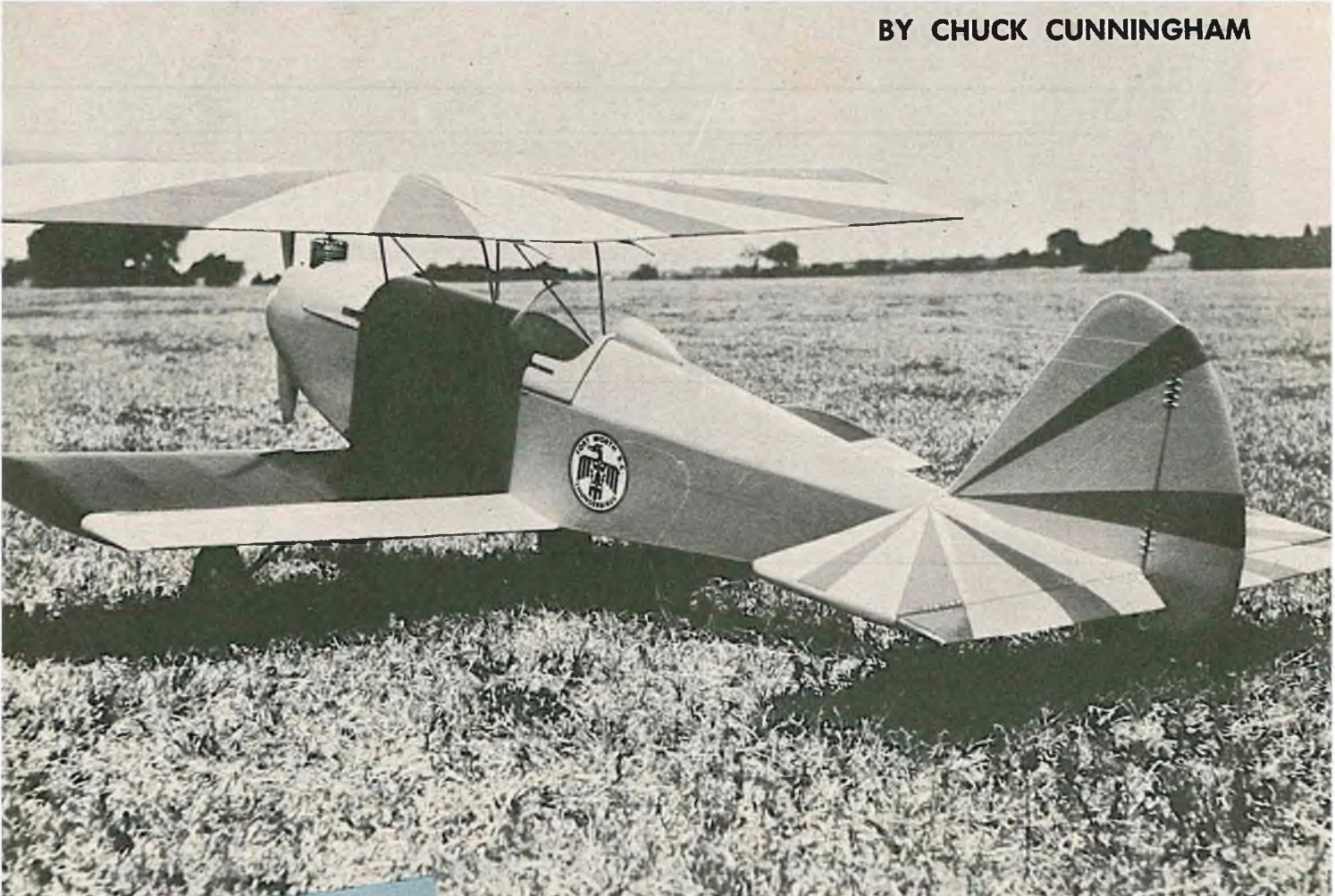

THE SHOWOFF

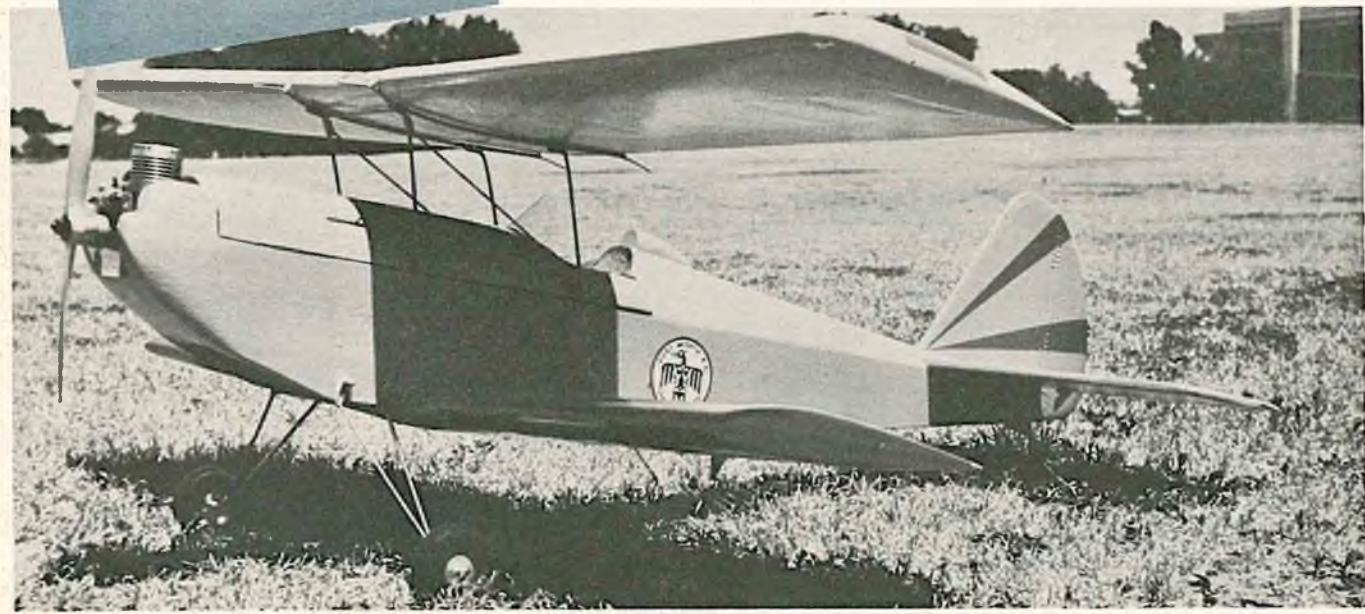

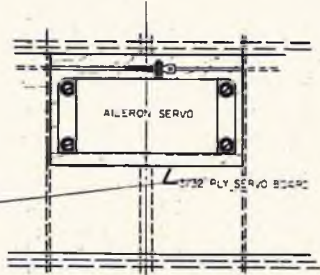
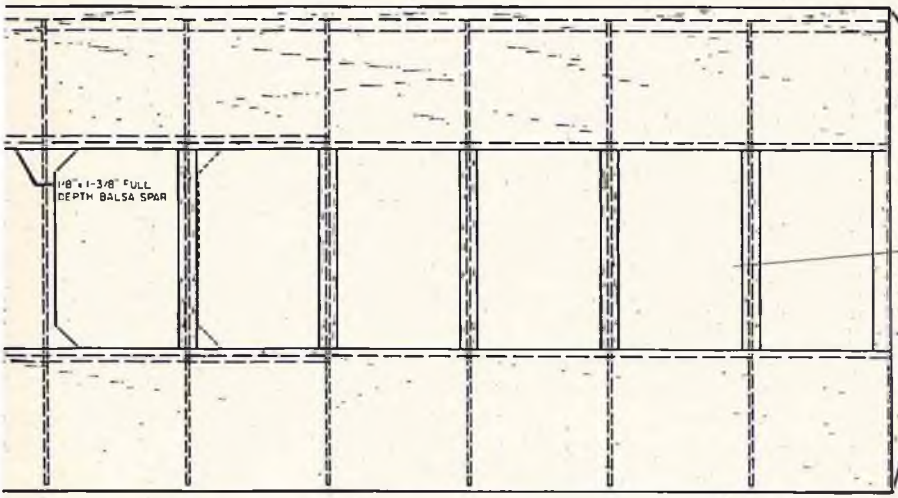

DETAIL OF AILERON SERVO INSTALLATION (LOWER WING)

SECTION A - TOP VIEW OF LOWER WING

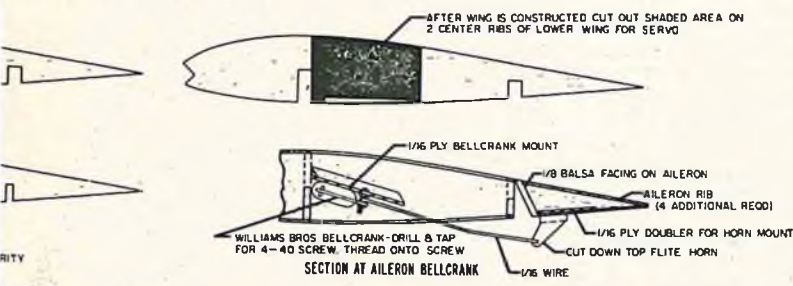

SECTION AT AILERON BELLCRANK

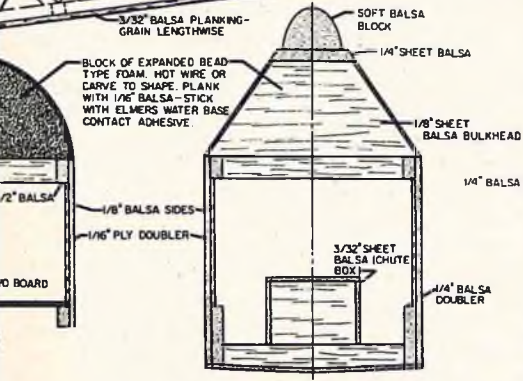
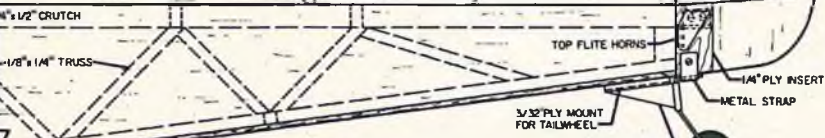
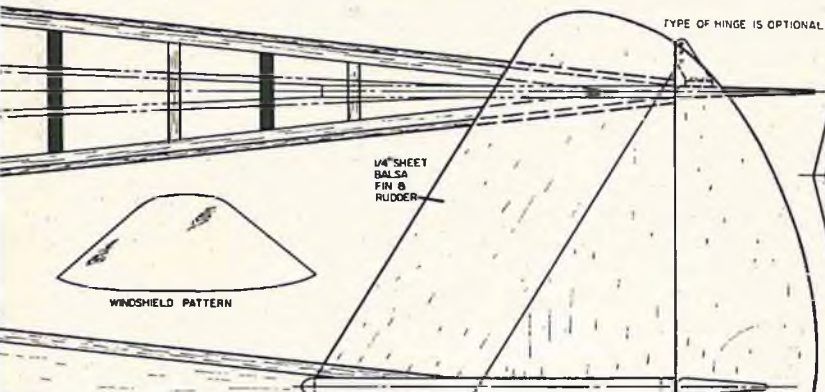

SECTION C-C

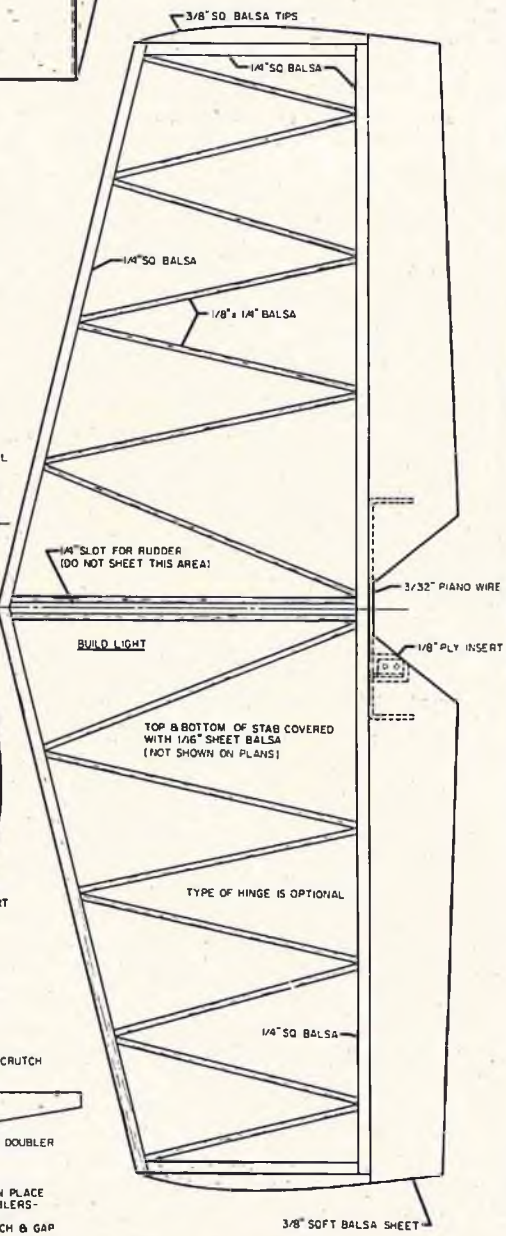

- BUILDING NOTES**
- 1 BUILD CRUTCH ON TOP VIEW-LEAVE PINNED IN PLACE
 - 2 BUILD SIDES-USE CONTACT CEMENT FOR DOUBLERS-LEAVE 1/2" GAP FOR CRUTCH
 - 3 APPLY CONTACT CEMENT TO OUTSIDE OF CRUTCH & GAP ON SIDES
 - 4 VERY CAREFULLY (BEGIN AT NOSE) PLACE SIDES AGAINST CRUTCH & SMOOTH INTO PLACE
 - 5 INSTALL BOTTOM CROSS BRACES
 - 6 INSTALL FIREWALL-PRE-DRILL HOLES FOR RADIAL MOUNT
 - 7 PLANK BOTTOM (REMOVE PINS IN CRUTCH FIRST)
 - 8 LIFT FROM BOARD & GLUE ON 3" x 5" PIECE OF BEAD TYPE FOAM (4" DENSITY) CARVE OR HOT WIRE TO SHAPE
 - 9 PLANK WITH 1/16" SHEET Balsa & WATER BASE CONTACT DR WHITE GLUE

R/C modeler SHOW-OFF

DESIGNED BY: DUKE CURRYHOAR DRAWN BY: DICK LEO

HOW often have you heard someone say — “Boy! I’d sure like to build a biplane!” Quite possibly you might have said that very thing, yourself, since almost every RC’er, at one time, has wanted to build a biplane, but for one reason or another, puts it off as a project for “tomorrow.” This has been my own reaction for a number of years, but finally, the lure of the new free-style aerobatic event was the impetus that finally gave birth to the Showoff.

This is not a scale biplane, but rather my own interpretation of a 1930 vintage biplane. It has the looks of an air show craft, sitting on the runway, and you can’t help but wish that you could jump into the cockpit and buzz off with the sharp feel of wind in your face and the singing of rigging wires in your ears. All in all, it’s a biplane fanciers’ biplane — and one that will perform the exotic maneuvers of the free style aerobatic event that is currently skyrocketing in popularity. A few “pulses” for the Showoff are the ease of construction, economy of materials, plus a parachute hatch and bomb drop for that “extra touch” of airmanship. Now that you’ve read this far, and possibly have an incurable case of biplane fever, let’s take a journey into the why’s and wherefore’s of biplane design as related to R/C models. Even if you don’t build the Showoff, you can apply the same principles to the WW I masterpiece that is flitting around in the back of your head.

Design

One of the factors that we must recognize in biplane design is that the good old double winger just isn’t as efficient as our standard monoplane, so our design must incorporate certain standards that will allow it to fly as well as the more conventional monoplane. As an example, the wings of the biplane are only 80% as efficient as a monoplane — so to arrive at the size of our biplane, let’s first decide on a size for a single wing ship and then take it from there. In the case of the Showoff, we wanted a ship that would stay in the same league as most of today’s multi stunt ships, thus a monoplane size of 720 square inch wing was chosen. Since the biplane is only 80% efficient, we multiply the 720 by 125% and arrive at 900 square inches.

In reality, the Showoff has 880 square inches, plus tips. The two wings of a biplane do not support the load of the air equally, but rather, the top wing is responsible for approximately 58% of the load while the bottom holds up the remaining 42%. Therefore, the top wing should be larger than the bottom wing. If the two are the same size, the lower wing does less work and adds more

drag. Since the Showoff has a total wing area of 880 square inches, 58% of this is 500 square inches and 42% is 380 square inches. In order to keep to the general design that I wanted, I digressed slightly from these figures and wound up with a tip wing of 48” span (plus two one inch tips) and a 10” chord for an overall area of 480 square inches. The lower wing evolved to a span of 40” plus tips with a 10” chord — an area of 400 square inches.

The elevator of a biplane is a single surface, and therefore is acting in the same manner as a monoplane. Since 25% of the wing area is standard for the elevator on a monoplane, then 20% of our biplane wing area will be the formula — in this case, 176 square inches. The rudder is similar, and 7.5% of the monoplane area equals a total of 54” of area.

Most of us know that the gap between the two wings should be at least the same distance as the width of the chord — this gap being measured at the zero datum line of each wing airfoil. The stagger, to be most efficient, should be in the neighborhood of one-half of the wing chord. To find the correct balance point on a biplane, assume that the two wings together make one wide wing chord, measuring from the leading edge of the top wing to the trailing edge of the bottom wing. The correct C.G. location is then 33% to 40% of this overall chord.

There you have, in a nut shell, the basic design reasoning behind the Showoff. If you’ve had enough of theory and the “why’s” and “what’s” of a biplane, then put aside your current hot stunt ship, grab your leather helmet and goggles, and let’s get on with it!

Construction

Wings. Since I hate to build them (and I suspect you do, too), let’s start with the wings and get them out of the way. Don’t be overly alarmed about the amount of materials and time involved — my own Scottish blood runs deep, so plan ahead and we’ll save a bit of wood as we go along.

These wings employ a 15% airfoil (a slightly modified 2415), and use the planked leading and trailing edge, plus cap strip, method of construction. First, cut out all of the sheets necessary for the leading and trailing edge planking. You will need eight sheets of 1/8” x 24” balsa for the top wing, and eight sheets of 20” long material for the lower wing. After cutting these from 3” wide by 36” long sheets of Sig’s finest, you will have 16 pieces of balsa remaining — varying from 12” to 16”. If you are careful in placing your rib template, you should be able to get all of the wing ribs from the drops

from these sheets.

Make the rib template in any manner that suits you. I have found that a template made from hard balsa works just as well as one fabricated from plywood or aluminum sheet — and a heck of a lot easier to make! Use a ball point pen to outline the ribs, then go back and cut them all out. Stock the completed ribs together and sand to final shape. Leave this stack pinned in one big lump, put a razor saw blade in your X-acto knife, and saw out the slots for the spars. The latter are made from hard 1/8” balsa and are full depth. We are going to use the “egg crate” method which will give you a very strong wing with only 1/16” balsa used for the ribs and sheeting. Cost wise, this is a substantial savings over 3/32” sheet.

Mark the location of each rib on the full depth spar and then slot the spars with the razor saw to accept the ribs. Notch the ribs at the center section for the dihedral brace — in this case, again simply hard 1/8” balsa. This is not cut to a dihedral angle, but rather, is one long piece of straight wood, trimmed on the bottom edge only to the dihedral angle. Wings built in this manner are extremely strong. I have used this construction technique on many large, high-powered multi’s and have never had a wing fail from structural weakness.

Use a good, flat, non-warped building board, lay out the plans, cover with wax paper, carve out the “prop-up” blocks as shown on the plans, count out the correct number of ribs for each wing half, and get set to build a very easy and true wing.

First, pin down the bottom trailing edge sheet on the plan. Now assemble the ribs on the two spars — don’t glue them as yet, but simply slip into place. Now lay a bead of white glue on the trailing edge sheet at the place where each rib is to be located. Pin three prop-up blocks along the leading edge of the wing, smear glue along the front top of the trailing edge sheet, and place the rib/spar mess on to the trailing edge. Put glue on each rib at the leading edge location, pin the leading edge in place on the ribs and on to the prop-up blocks, and then be sure that the entire assembly is properly aligned. If everything is in its correct location, dip a small brush into your white glue bottle and brush white glue on every joint and on each side of the rib and spar joints.

After you have taken the kinks out of your back, it’s time for the next step. Brush a coat of contact cement on to the wing ribs and the corresponding place

(Continued on Page 66)

An RCM Technical Feature

USE YOUR AUTO FOR CHARGING NICADS

By Jack Sellors

AUTOMOTIVE battery systems provide an excellent source of voltage for charging your nickel cadmium batteries while driving to a contest or your favorite flying field. You also can easily peak off your batteries between rounds of the contests to insure no missed signals caused by low voltage.

Modern automotive ignition systems use 12 volt D.C. lead-acid storage batteries, usually 50 ampere/hour capacity or higher. The automotive recharging system — the generator and regulator — puts out a voltage that varies with engine speed within controlled limits. The voltage regulator usually keeps the voltage from rising above 14 volts D.C. even at maximum speeds.

The simple charging system for your model batteries uses the automotive electrical circuit with a suitable voltage dropping resistor to control current flow. Resistor capacity is determined by battery size. The table lists appropriate dropping resistor values and wattage ratings for various numbers of cells in series. Use at least the ohmic resistances indicated or slightly higher. The charging rates are listed for full car engine speed. With the engine off the rates are about 20% lower. This will insure that excessive charging rates never occur.

Each of my planes have a miniature phone jack installed on the fuselage next to the switch on the side opposite the exhaust stack. All home based chargers are equipped with miniature phone plugs to match so that batteries may be charged from transformer supplies without removal from the models.

The charging jack and plug are wired with the tip positive and solid sleeve negative. The wires from the jack are soldered to each end of the series connected battery pack. The charging system in the car uses a similar plug to match the jack.

The one-half watt resistors are soldered

SERIES RESISTOR VALUES IN OHMS					
No. of Cells in Series	All 1/2 Watt 22MA	50MA	60MA	120MA	400MA
1	570	250	210	105	32
2	510	1W	1W	2W	10W
3	450	225	190	93	28
4	380	1W	1W	2W	5W
5	320	200	165	82	24
6	250	1W	1W	2W	5W
7	190	170	140	70	21
8	130	1W	1W	2W	5W
9	65	140	120	60	18
		1/2W	1W	2W	5W
		110	95	47	14
		85	70	35	10
		1/2W	1/2W	1W	2W
		55	47	23	7.0
		1/2W	1/2W	1W	2W
		27	23	12	3.5
		1/2W	1/2W	1W	1W

For 2 volt wet cells (starting batteries) use 10 ohm, 10 watt dropping resistor for 1 amp. flow.

directly to the center tab on the miniature plugs. They fit neatly inside the

plastic covers after assembly. Three or four foot leads are provided from the plug. At the other end, the leads are connected to the car electrical system in the trunk. Be sure to pick up a wire that is hot all the time. I use the wire feeding the trunk light — check polarity on your system. Make sure you have a good ground connection to the body. After installation, check the charging rates on your batteries to make sure the 10 hour rate is not exceeded. This check should be made with the engine running at more than idle speed. Increase the resistance, if necessary, to lower the charging rate.

Resistor values are not critical. If the specified value is not available use the next higher resistance. Ten per cent (10%) tolerance ratings are adequate. The voltage dropping resistor can also be installed inside the barrel of an adapter for the cigarette lighter socket. When the charging plugs are not in use they should be protected from accidental shorting to the metal in the trunk.

Another plug and dropping resistor assembly can be prepared for charging transmitter batteries. The plug should match the transmitter charging socket.

A really deluxe installation can easily be made with a metal panel mounted in the trunk with a group of sockets with appropriate dropping resistors installed behind the panel. A series of patch cords would make a variety of charging rates available. A five watt wire wound potentiometer with a meter in series might also be included to provide a variable charging rate system.

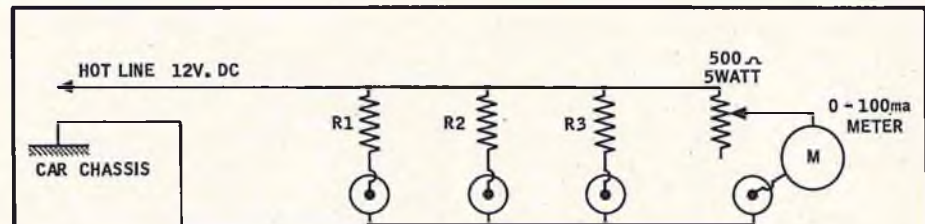
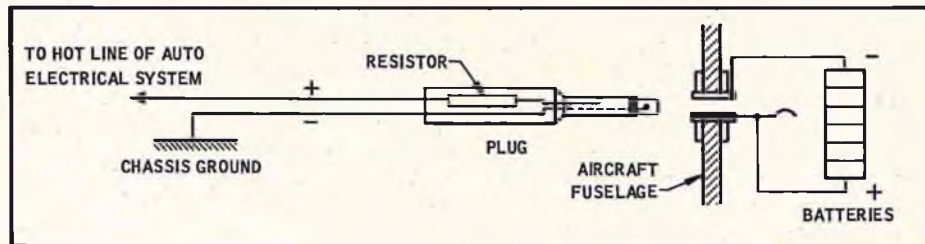

SUGGESTION FOR MULTIPLE SIMULTANEOUS CHARGING OF PLANE AND TRANSMITTER BATTERIES. PICK R1, R2, & R3 FOR RATES REQUIRED. USE PATCH CORDS BETWEEN JACKS AND RADIO EQUIPMENT



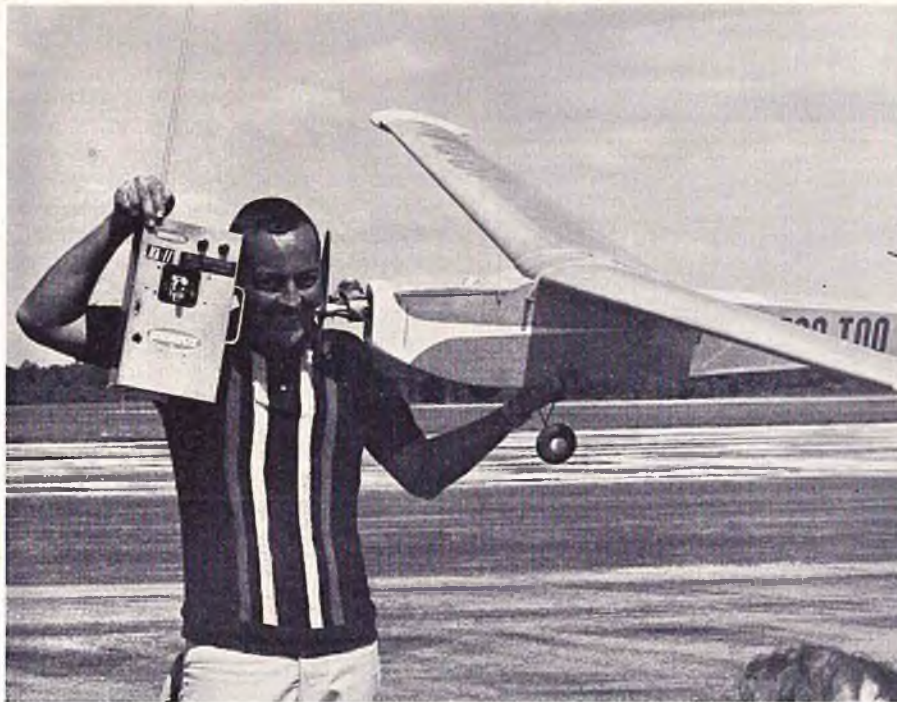

BILL NORTHROP SETS WORLD ALTITUDE RECORD AT DAHLGREN, VIRGINIA

TWO R/C world records and an absolute record were set at the Naval Weapons Laboratory, Dahlgren, Virginia, on September 5, 1965, subject to approval by the Federation Aeronautique Internationale in Paris.

William C. Northrop, Newark, Delaware, flew his Foo Too original design model to an altitude of 16,690 feet, besting the record of 13,328 feet set at Dahlgren in 1963 by Maynard Hill of Silver Spring, Maryland, according to the Academy of Model Aeronautics.

Mr. Northrop's flight also establishes

a new absolute world record for altitude by a model aircraft, previously about 13,700 feet, set in 1947 by Georges Lioubouchkine of the U.S.S.R. with a free flight model.

The other world record was for radio controlled glider speed, a new category in 1965 for which no previous record existed. Mr. Hill and Ben F. Givens, Wheaton, Maryland, a team entry, clocked a two-way average speed of 23 mph over the 50 meter straight course.

Attempts to break the radio control power speed record of 126.9 mph were

unsuccessful, the best average time being 114 mph by Mr. Hill. The radio control glider altitude record of about 2,600 feet was challenged, but not beaten, by Ray Smith of Silver Spring, Maryland, with a flight to 2,400 feet.

Altitude measurements were made by an X-band radar unit provided by the Navy. The Federal Aviation Agency provided cleared airspace above the base for the altitude attempts.

The invitational event was conducted by the D.C./R.C. Club, and was attended by members of two other Washington area clubs, NVRC and FARC. Totals of five gliders, four altitude craft, and four speed aircraft were entered.

Northrop's altitude aircraft had a 7.5 ft. span, weighed 7 pounds 3 ounces, fueled, and was powered by a Super Tigre .56, and carried Dee Bee MK-II radio equipment.

The Hill-Givens glider was an original design by Hill. It had a 10.5 foot span, weighed approximately five pounds, and carried Sampey 404 equipment. The record speed flight was flown by Mr. Givens.

Contest Director for the record trials was Carlton Middlebrook of Dahlgren. Donald Clark, Kensington, Maryland, directed the speed events, and Al Montzka, Washington, directed the altitude attempts.

The speed and altitude measuring devices were approved by the Academy of Model Aeronautics, and A.M.A. officials witnessed the record flights. The Academy will forward dossiers on the record flights to Paris for confirmation, expected within thirty days from the date of trials.

Also witnessing the flights was Dr. Walter A. Good, Bethesda, Maryland, President of the Committee for International Aero Modeling. The CIAM is the international organization governing record trials and world championships.

From Hobby Lobby International comes the photo of Jim Martin and his "Pussy Calore" — a modified version of deBolt's forthcoming Acrobat biplane. Jim's version has logged approximately 500 flights of twenty minutes or more on a Citizen-Ship 10 and F&M proportional system. The airplane is heavy, weighing 8½ pounds with equipment, but flies well with the K&B .45 due to its vast expanse of wing area. Both wings are MarLite foam cores. The tank is an Aerogloss 8 ounce dope can mounted sideways in the nose.

The big news is the biplane, itself. Those of us who are in a rut with the current crop of low wing multi's, deserve a treat like this biplane. The flying characteristics are sensational for the sport flier or newcomer to multi — flying like a Tri-Squire on rudder and elevator. Using the ailerons it



really shines at acrobatics, giving almost scale imitations of the home-built aerobatic ships such as the Pitts Special, Smith Miniplane, Knight-Twister, etc. This is a contest type of airplane that will hold its own with the Kwik-Fli and others, but it begins performing where the others leave off — a natural for the new Free-Style Aerobatic event.

INDIAN CITY 12TH ANNUAL

THE Indian City R/C Club's 12th Annual Contest has come and gone, and was the best attended and well organized meet in the club's long history of this annual affair. Despite the 95 degree temperatures for the week-end meet, Harold deBolt nudged out D. Ballreick for first place in Class III Expert by a narrow margin of 7½ points. In the Novice category, P. Schmitz won by an edge of only 1 point over K. Finkenbinder. Close behind in the third slot was Nick Zelinka, who traveled from Coral Gables, Florida to attend the Michigan event.

In Open Pylon, Hal deBolt was first, followed by B. Brown and C. Barnes. Mel Santmyer and Bill Bertrand were first and second in scale. Judges for the 12th Annual were Woody Woodward, Earl Hickman, and Paul Flocarri.

RCM EXCLUSIVE!

MAYNARD HILL SETS NEW STRAIGHT LINE R C WORLD DISTANCE RECORD

Maynard Hill, Noted R/C Records Man, Added Another Mark to His Achievements By Flying An R/C Aircraft From Batavia, N. Y., down the New York Thruway to Camajoharie, N. Y., a Distance of 188 Miles. Take Off Time Was 11:09 A.M., October 2, 1965. Hill Landed His Ship at 2:29 P.M., for An Average Speed of 58 M.P.H.!

HOW TO BEND DURAL ALUMINUM GEARS

Slot Racer Hardened Gear Axles

With Elastic Lock Nuts Top Off Project

From Bob Swearingen, in the St. Paul Model RC'ers Club 'Pulse,' a few notes about bending aluminum landing gear blanks. Since the only light weight material that will withstand the severe shocks of rough landings is tempered aluminum, it is unfortunate that this material cannot be formed into sharp bends without fracturing at the point of bending. To form this material to the desired radii, first make a pattern of the proposed gear from soft wire. This will give you a ready guide to determine the extent of each bend. Now, insert the aluminum gear blank into a bench vise and clamp it just short of the point where you wish to form the bend. With a pair of pliers, grip the gear blank a short way above the bend and apply pressure in the direction of the desired bend while applying heat with a Bernz-O-Matic, or other propane torch. Be sure to use a tip that concentrates the flame. Keep the torch moving in slow back and forth strokes across the area of the bend. When the heat is sufficient, you will feel the metal give under the pressure you are holding with the pliers. Remove the heat and check the bend for accuracy against your soft wire template. Try to get the bend correct the first time so that it will not be necessary

to re-heat the metal. Now, move the blank to the next bend and repeat the process. When working with 1/32" material, keep the work moving and be extremely careful not to overheat.

As the final touch to your newly formed gear blank, you might try the hardened and ground axles that are used for slot car racing. These are threaded on both ends with a 5-40 NC thread and are 3/8" diameter by 1 1/2" long. Use elastic lock nuts to hold to your aluminum gear, per the sketch attached. From the KCRC club.

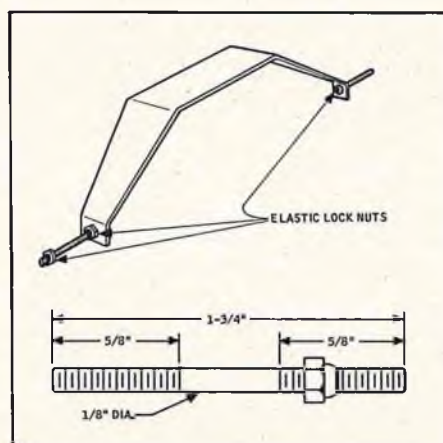

NATIONAL INTER-CLUB ORGANIZATION AND EXCHANGE ASKED

MARCS SPARKS (Madison Area Radio Control Society) presents some food for thought by guest editor Lloyd Zink: "It seems only a handful of the same people are shaping and guiding policies and opinions, and yet there is an almost unlimited amount of unused talent not only in our club but other localities as well. We RC'ers are being confronted with a growing number of new problems each day and yet most of the old ones still exist or at least are only temporarily satisfied. I'm sure we're nearly all aware of obstacles like Flying Sites, frequency allocation, engine noise in suburban areas, interesting more young people in the hobby and not to mention lack of qualified help for beginners in the hobby. These obstacles being undissolved will surely discourage or suppress the sport as we know it in many areas. It may well be some of these problems are self inflicted through the ignorance of even the more informed of our own ranks.

"I feel a great deal can be accomplished simply by logical thinking and systematic inter-club organization. Also, more personal contacts between flyers in other areas by weekend flying sessions. This allows contact with not only contest flyers and club members in other areas but small groups and individual flyers as well. We are certainly not few in numbers but tend in many cases to struggle by ourselves in isolated small groups or individually confronted with the same large problems . . . Indeed the largest burden of responsibility lies on us individually to relate views and ideas through media available, including newsletters, model mags or even personal visits to local organizations, schools or local governments to create interest or at least a little sympathy toward our cause. I am inviting comments pro and con and ideas on solutions or experiences, failures or successes on problems of our hobby, so to anyone wishing to contact me feel free to write or call Lloyd E. Zink, R.R. #2, Lodi, Wisconsin 53555, or phone Lodi - 608-592-4142."

HAIR DYE BOTTLE DOUBLES AS FUEL TANK

If you need a replacement bottle for a six ounce plastic tank, go to your local drugstore and ask for the plastic bottle used to mix Miss Clairol hair dye - costs only 39c. From the WORKS 'Worksheet.'

TRANSMITTER SWITCH LOCK . . .

If you have ever had the experience of traveling out to the field for an afternoon of flying, only to find that your transmitter or plane switches had been accidentally knocked on, then you will appreciate the simple arrangement presented by Rich Piccola in the NJRCC 'Printed Circuit.' But **do** remember to remove the safety switch before launching the plane. . . .

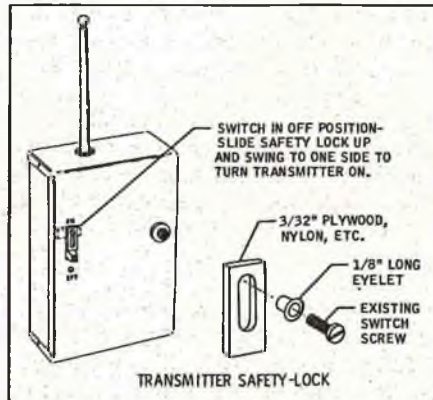

Eldon J. Lind poses with a young aviatrix, Christina C. Alagna of West Van Nuys, California. Eldon and Orion competed in the recent Cal-Western AAA A.M.A. meet.

WICHITA MODEL COUNCIL AND R/C CLUB HOST 5TH MIDWESTERN CHAMPS



Top: Loren Tregalles, with his scale winning P-63. Above: Processing area.

FLY BY - - - - -

The multi contest sponsored by the Kalamazoo RC Club, and sanctioned by the Academy of Model Aeronautics at

Three Rivers Haines Airport, Three Rivers, Michigan, was won by Harold Parenti of Chicago, competing in the Expert Class. Don Ballreich of Tiffin, Ohio was second, followed by Glen Roe of Grand Rapids, Michigan.

In the Novice competition, Charles Williams of Kalamazoo was first, Mel Santmyer of Detroit, second, and Keith Finkenbiner of Maumee, Ohio, third.

Each contestant completed six flights and was judged on the best two. The next scheduled contest for the Kalamazoo RC Club will be next Memorial Day.

An engine hint from Ken Harty in the Windy City 'Newsletter' concerns the film of varnish that develops on the head and cooling fins after a few hours of operation. The problem can be solved by using silicone grease, thinned down with dope thinner and brushed lightly over all exterior parts of a new or recently cleaned engine. The result is increased cooling efficiency and no varnish deposits on the outside, even after hours of operation.

The Long Island Drone Society recently entertained fifty orphans at a Fly-For-Fun Day held at their field at Mitchell AFB. According to LIDS member, Dr. Irwin Bloomberg, it was a rewarding experience to see the group of kids having such a good time. Food was supplied by TWA and Eastern Air Lines, milk by Bordens, and ice cream by the Good Humor company. Since this event was so well received, the LIDS plan to make it an annual affair.

We would like to extend our thanks and congratulations to the Long Island group for their thoughtfulness in sharing their activities with a group of youngsters who do not have the same advantages as our own children.

No matter how great your problems, if you look around you will find someone with problems that you couldn't have thought of even in your worst nightmare! One such problem is facing the members of the **Western Carolina Radio Control Club**. Anti-aircraft guns! Permission was granted for the members to use a particular site near Greer for the summer. However, certain residents in the area were not so magnanimous. One man threatened to use his shotgun on any model airplanes that crossed his property. Frank Dossier, member of the club board of directors, has met with most of the nearby residents. "Most of the nearby people were satisfied we would cause no damage, but two said they didn't want us there." If no agreement can be reached, another club will be added to the long list of "looking for a flying site." Frank is still hopeful something can be worked out over the conference table.

Keep the club papers, contest results, and photographs coming. While we don't have the space to print all of them, we'll do our best. Black and white glossies, or Polaroids are best, although we can make black and white prints from 35mm color slides.

See 'ya next time around.



REGATTA

Darrell Sunde of Renton, Washington, with R/C tug 'Samson' at Seattle boat show. 4 Channel Orbit with built-in switching for fog whistle, engine room bells, and flashing mast lights. Pittman Boatmaster electric drive. Seattle Model Yacht Club. Photo by George Hickson.

THE Aurora Model Power Boat Club held their First Annual Invitational IMPBA Regatta on Father's Day, June 20th. The site was Mastadon Lake in Phillips Park, Aurora, Illinois. The day, itself, was a warm eighty-plus degrees with quite a bit of wind — the latter providing the less experienced boatmen with a fair share of trouble.

Four different classes of gas speed were offered on the quarter mile IMPBA oval. In Class C, for up to .29 cu. in. displacement, Bob Voelker, with a proxy run by Ron Buck, was 1st with a time of 50.7. Second place went to Lee Pender with 54.3, and third place honors were taken by Carver Penwell and 1:04.5.

In Class D, for .30 to .45 cu. in., Dick Young, Fred Sponholts, and Marianne Preusse were the winning trio, with times of 1:03.1, 1:46, and 1:55.3, respectively.

In Class E, for .46 to .60 cu. in., a time of 42.9 eased Ron Buck into first place, with John Scherer and Roy Miller fighting out the second and third slot with narrowly separated times of 57.6 and 58.7.

For the larger mills over .60 cu. in., the Class F event drew Ron Schwiesow into the winner's circle with a time of 43.2. Mert Mischnick was second with 49.8, and Sam Newman edged out the third position with 55.1.

In spite of the high winds, a newcomer to the model boat racing clan made a fine run with his White Heat and a beautifully customized Super Tigre. Ron Buck — a name to watch!

The Minute Breakers Fourth Annual Invitational Regatta was held July 24-25 at Lombard, Illinois, drawing contestants from Michigan, Wisconsin, Illinois, and Canada. Top winner of the Invitational was Ron Buck of Wheaton, Illinois, a member of the Minute Breakers, who, in his first season of R/C boating, set the pace earlier this year at Cape Coral and the Aurora First Annual. After setting a new record of 35.5 seconds for the one quarter mile IMPBA Oval in Class E at Cape Coral, Florida, Ron took first in one-quarter mile oval, one-sixteenth mile straightaway, and multi-boat racing at the Lombard, Illi-

nois Regatta. The boat, a plywood White Heat 60, was powered with a Rossi 60 mill turning an X50 plastic prop. A Controlaire transmitter and receiver feed a Royal multi servo for steering. Ron also took 1st in Class E, one-quarter mile oval, and one-sixteenth mile straightaway at the Tri-City Radio Controllers at Beloit, Wisconsin. The following week, at Racine, Wisconsin, Ron took 1st in Class C on exceptionally rough water.

The first day of the two day weekend Minute Breakers Invitational was devoted to running two lap speed on the IMPBA quarter-mile oval in addition to running boats through the 1/16 mile timing traps. These vents were continued Sunday morning and up until the start of the multi-boat races at 2:00 P.M. Saturday was marked by two accidents — one in which Marianne Preusse ran her fast Cobra Junior over an unnoticed piece of floating lumber, causing a crash dive to the bottom of the pond. Fortunately, the only damage was a lost propeller and a very wet engine! Mrs. Preusse subsequently

went on to set a new record on the straight 1/16 mile for a .30-.45 proto. The second accident of the day was of a more serious nature when Bob Voelker ran his White Heat 30 into a partially submerged shopping cart! All-kidding aside — it **was** a shopping cart from a local supermarket which some good citizen had taken home and later disposed of in the lagoon!

Ron Schwiesow of the Aurora Club ran his O&R powered White Heat for a new IMPBA record of 38.9 seconds, only to be beaten less than fifteen minutes later by Earl Mundt of the Minute Breakers with his Tas powered G.E.M. Super Challenger. The new record is now a fast 37.3 seconds.

Another record was established on Saturday when Lee Pender ran his Tigre .29 powered Challenger Jr. through the traps and came up with a two-way average of 23.5 MPH. Incidentally, Lee has established a new .29 record with a G.E.M. kit and is eligible for their \$25 award certificate.

Sunday, after many elimination runs, Ron Buck won the multiple boat contest with his White Heat. A tough battle ensued for second place between Sam Newman of the Skippers and Donn Jordan of the Minute Breakers. Each man, in turn, would fire up his engine, only to have it stop short of the required six laps. This went on for some time until, finally, a flip of the coin had to decide the issue.

The Tri-City Radio Controllers held their Annual Invitational Regatta in Forest Park, Beloit, Wisconsin, on Sunday, August 15. The Straight 1/16 mile and the 1/4 mile oval were the speed events offered. And if you like very hot, humid weather, it was a perfect day! If you don't, you just sat around and tried in vain to find a cool breeze somewhere!

The Beloit club has a beautiful pond just to one side of the Rock River. Since they've been having a considerable amount of trouble with water pollution, the city pumps several thousand gallons of fresh water into the lagoon via two steel pipes which terminate in the middle of the 1/4 mile oval! This provides a bit of an obstacle to anyone running the course — especially the faster running hydros. Midway through the day, Sam "On-The-Rocks" Newman removed one of these obstacles with his O&R powered "Lollypop." It would be interesting to hear what the Beloit city fathers had to say about that incident!

Ron Buck continued his winning streak with the same Rossi-powered White Heat. It seems impossible to beat a Rossi unless you use another Rossi — or witchcraft! Jack Peterson placed second to Ron in both .60 events with a Tigre-powered Challenger II. IMPBA proxy Mert Mischnick was top dog in the Class F oval and second in the

Straight 1/16 mile with his O&R powered Trident.

Marianne Preusse surprised everyone to win against some really fast, but somewhat unlucky, hydros. Randy Peterson, Beloit's youngest contestant, was right behind Marianne's pink and white Jr. Cobra with his Tigre-powered Jr. Challenger.

The Racine Wing and Hull Club held their regatta on the following Sunday, August 22. Their pond is in sharp contrast to the one in Beloit — or to any other, for that matter. Not-so-affectionately named "rock haven" by local boatmen, it could be called by any other name which adequately describes solid rock about thirty feet straight up and down and a bottom which goes as deep as 96 feet. Sounds great — for just about anything but model boat racing! The rock walls are unforgiving, but if you have a throttle or engine cut-off, you stand a good chance of taking home all the pieces. The Racine group furnishes a row boat for retrieving anything that doesn't sink, and Earl Mundt brings his Scuba gear for retrieving anything that does!

Frank Toth of the Chicago club took first place in Class C with a hot .29 powered Berkeley Cobra. Frank also holds the new IMPBA record in that class, as well. In class E Oval, Ron Buck added another first place trophy to his collection. He was followed in short order by Larry Atkinson of Beloit, Wisconsin, with a nice running black hydro.

Ron Schwiesow of Aurora, Illinois, sped away with a first in the Class F Oval, followed by the orange and white Trident operated by Mert Mischnick.

First place in the gas slalom event went to Richard Svengaard of Eau Claire, Wisconsin, followed closely by Ron Buck. First slot honors in the electric slalom course went to Roy Miller of Chicago who operates an electric-powered tugboat.

Here on the West Coast, where it seems almost impossible to obtain detailed data or photographs of R/C boating activities, we have at least had a few isolated reports of varied and sundry activities. If this sounds like a dig at West Coast boatmen — it is just that. It is impossible for RCM to attend the various contests around the country, so we must depend on the local clubs to send in details of their Regattas. So if you don't want the world to think that the "fastest and finest" are all East of the Mississippi, send the results, commentaries, and black and white photographs to R/C Modeler Magazine, Regatta Editor, P. O. Box 487, Sierra Madre, California.

One of the most beautiful boats we have seen locally is a 49" GEM fiberglass Cobra built by Brad Langdale,

Vice President of the Radio Control League of Orange County. Brad uses an O&R Compact for power and has adapted a V-8 manifold which sticks up through the rear hatch. Radio gear is a Bonner Digimite Proportional which works exceptionally well in the Cobra. In addition to engine throttle and rudder control, Brad has installed an additional servo which is linked to two door-bell type switches. When this servo is at one end of its travel, it pushes one of the switches and activates an electric siren which is situated under the front seat. In the same circuit with the siren is a red light which blinks on and off. When the servo is at full throw in the opposite direction, it closes the other switch which grounds out the magneto and kills the engine. All radio gear is enclosed in a watertight fiberglass coated wood box. Pushrods from the servos inside the box to the controls on the outside pass through brass tubing, making a completely watertight unit. All unused areas of the boat are filled with poly-urethane foam to prevent sinking in case the boat gets swamped.

Internally, the cockpit is fully carpeted and all wood surfaces are covered with mahogany grained shelf paper. The dashboard is complete with Tatone instruments and a micro switch which operates the running lights. Finish is a magnificent red, white, and blue. A marine in full dress uniform sits behind the wheel.

Brad's Cobra was first run at the Marine Stadium in Long Beach, and although it weighs 21 pounds, planed easily and was quite exciting to operate.

Although we have no details on the contest itself, rumors were heard around the recent Modeleers multiple boat contest at Legg Lake, in San Gabriel Valley, California, that another R/C boat run to Catalina Island may be in the offing. If so, would someone please let us know when, where, etc?

And that's it for this month. In the next issue, along with the regular boating activities from around the country, RCM will present a special report on R/C boat racing activities in West Germany — a special report by Holger Schweizer, complete with photographs, course details, etc. We think you'll like it.

It's even easier to get data on R/C boating from overseas than it is from Southern California. If worse comes to worse, RCM's Chuck Waas will take his big O&R powered Hydro, Don Dewey his Norco Newporter and Dumas SK boat, and Bill O'Brien his 6 meter sailboat and hold their own private meet at Puddingstone Dam. They sure won't be any threat to Ron Buck, Gary Preusse, or Earl Mundt, but at least it'll prove the West Coast is still alive. . . .

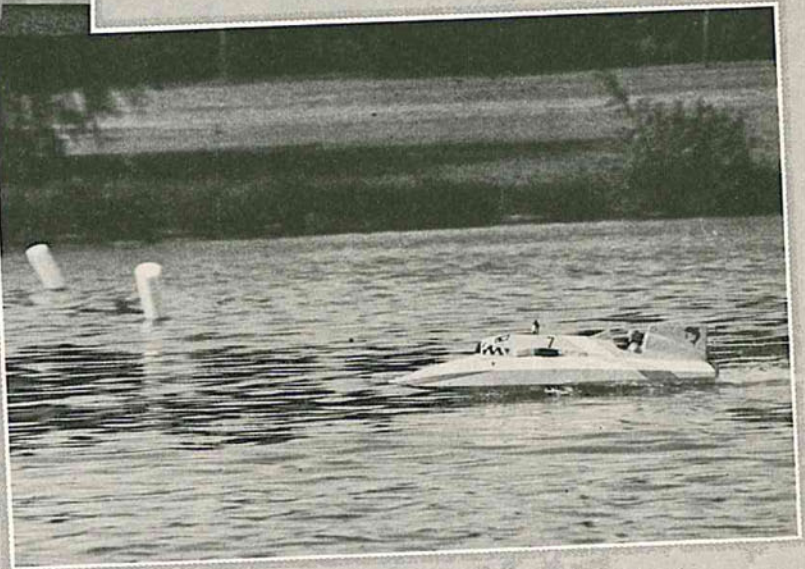
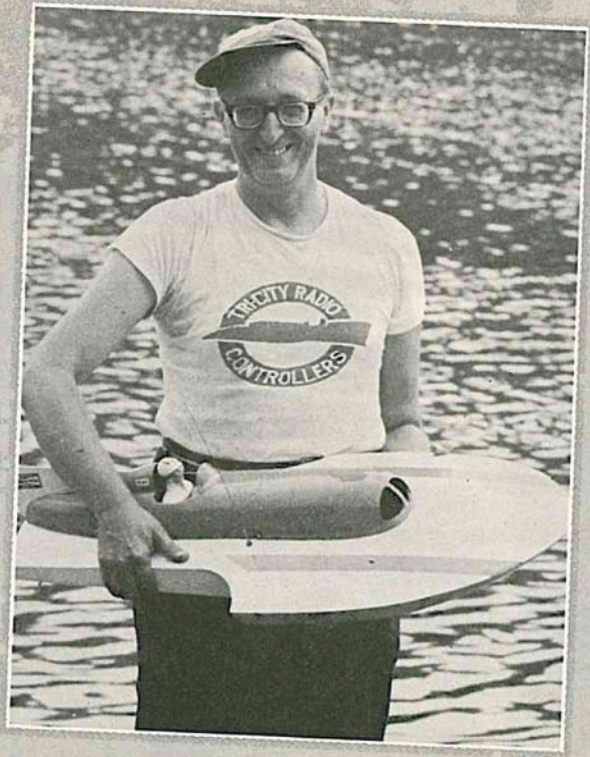

Top, left: Ron Buck with record breaking Class E boat at Minute Breakers Regatta. Above: winners at the Tri-City Radio Controllers Annual Invitational Regatta. Top, Right: Merle Kobernick with his fast S.T. powered Challenger II at Aurora 1st. Annual. Right: Donn Jordan's TAS powered fiberglass White Heat X at Aurora. Below: Brad Langdale's Cobra. Below, right: Custom Twin McCoy built by west coaster Richard Tyler.

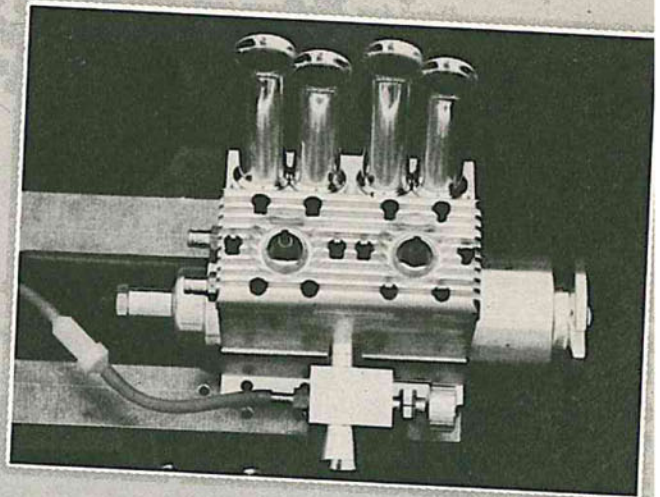
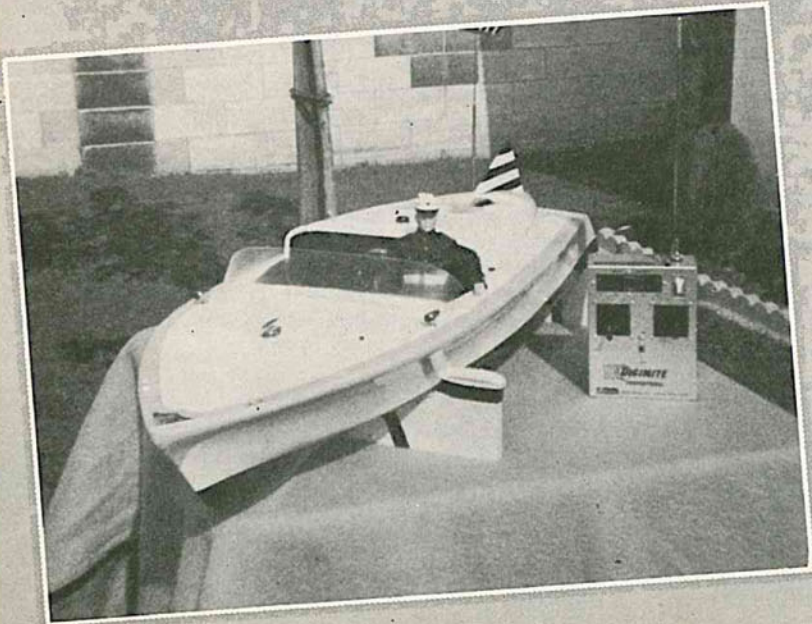

AN RCM BOATING SPECIAL
... BUILDING THE DUMAS

SK DADDLE TOO

HOW TO GET GOING
IN R/C BOATING ...

FAST

STEP BY STEP INSTRUCTIONS FOR
BUILDING THE R/C KIT

VERSION OF THE FAMOUS

HALLETT "SK" BOAT

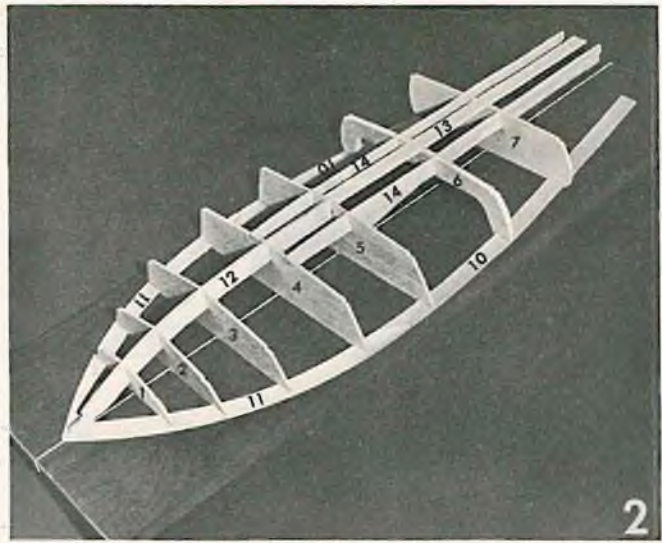
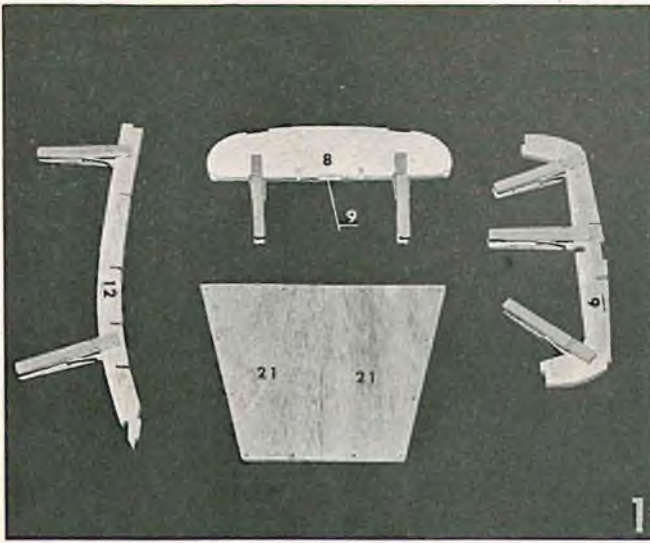

ONE of the most interesting and challenging aspects of radio control is the variety of projects and activities available to the ardent enthusiast. Although a vast majority of RC'ers are concentrated in the model aircraft field, more and more are trying their hand at R/C boating. This is one phase of radio control that is as exciting as it is challenging, and an aspect of the hobby in which the entire family can participate.

For the active R/C boat modeler, the challenge in his phase of the sport may take the form of racing competition, or detailed, exacting craftsmanship, or even hand-crafting his own racing engines. This is comparable to the experienced and proficient multi-pilot in the aircraft field who leans toward Class III, pylon racing, or scale competition. For the beginner, however, the question is always the same — "Where do I begin?"

As this article is being written, Dumas Boats is in the process of releasing two new kits that can provide the answer to this question. These kits, the SK Daddle and SK Daddle Too are scale models of the Hallett "SK" Boat, designed by the famous designer-driver, Rich Hallett, and built by the Barron Boat Works of Irwindale, California. The full sized

"SK" boats are in the 60-80 MPH class and are used for all sorts of boat racing, marathon, drag, and sprint. These boats are nearly all engine since 500-600 horsepower is packed into an eighteen foot length. SK races are held on the Salton Sea in California, on Lake Havasu on the Colorado River, and on many other lakes around the country.

Dumas Boats, in scaling down these ships for the RC'er, wanted a boat for both the experienced model builder as well as for someone who wants to run a boat but has never built one. The design had to be a scale model of an existing boat that was rugged, yet easy to build, and when finished, would be able to get out and go! The new design was also to be a "One Design" that could be used as a standard for multiple boat racing. The answer came in the form of the 36" long SK Daddle and the smaller 27" SK Daddle Too.

After building one of the kit prototypes, here at RCM, we felt that this was an ideal boat for the newcomer to R/C, fast, stable, watertight compartment for radio equipment, lots of room, no cabin or cover — as Jay Brandon of Dumas stated, "Just a going boat!" So, if you've been thinking of R/C boat-

ing, and wondering how to get started, this is for you. Obtain the SK Daddle Too from your local hobby dealer, follow these step-by-step instructions, and you're on your way to an exciting new aspect of the world's fastest growing hobby.

Construction

General.

Use waterproof or water resistant glue such as Weldwood Plastic Resin glue, or Epoxy cement. Don't use contact cement or white glue. You will find Model Aircraft cement will dry too fast for boat use.

Tools and supplies required:

- 12 Spring-type clothes pins.
- 6 Small 1"-2" "C" clamps.
- 4 Large 4"-6" "C" clamps.
- 1 Small screwdriver.
- 1 Model makers saw.
- 1 Sharp knife.
- 1 Sand paper 3/0.

Wet or Dry Paper — 400 grit.

Glue or cement.

Masking tape.

$\frac{3}{16}$ " drill.

Small drills for screw holes.

A small plane will be a handy tool to have.

A board or table top — $\frac{3}{4}$ " x 12" x

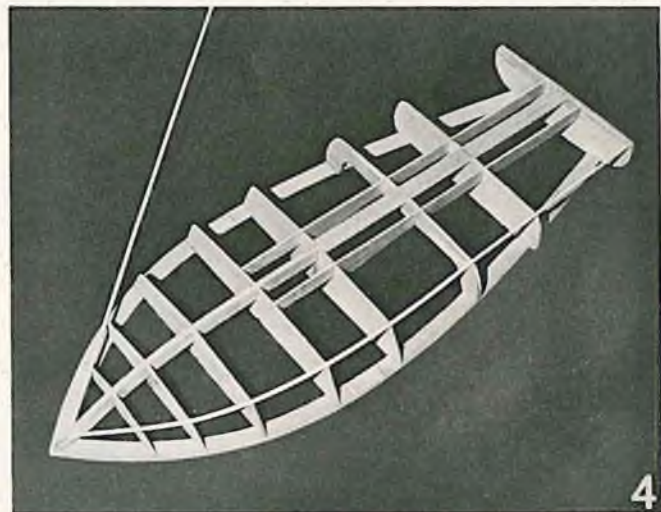
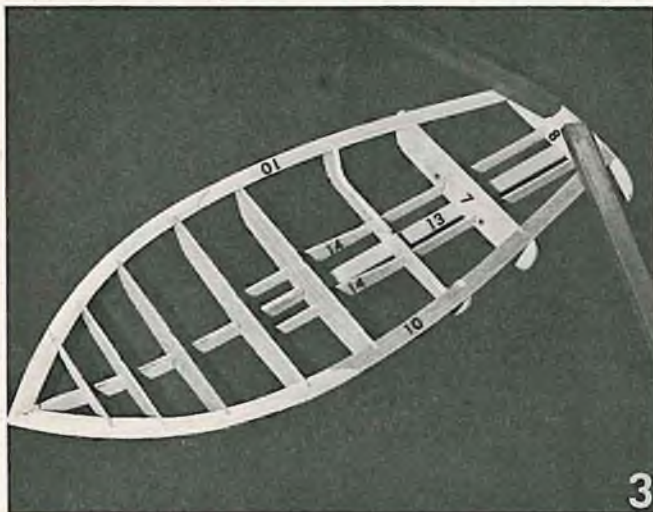



30" for construction surface.
Fig. 1. Glue the following together:

- Transom, 8 and 9
- Deck, 21 and 21
- Keel, 12 and 12
- Frame, 6 and 6

Fig. 2. Draw straight line 30" long (or use a string) on the construction board or table top. Place Sheer 10 and 11 on construction board which has been covered with wax paper. Drill two holes through Frame 7 for $\frac{1}{8}$ " dia. brass tube for water cooling of engine, see Fig. 3 — location not critical. Assemble Frames 1 through 7, Keels 12 and 13, and Stringers 14 in position as shown. Remove pieces and glue as you reassemble. Use plenty of glue. Measure at Frame 4 and at Frame 7 to make sure the string or line is in the center of boat.

Make glue blocks from scrap wood and glue over joint in Sheer 10 and 11 (Shown on Fig. 4).

Fig. 3. Turn boat over. Glue Transom 8 and 9 in position, fitting Sheer 10, Keel 13, and Stringers 14 into notches. Use weights or clamps to hold Sheer 10 in position. Make sure boat frame is not twisted.

Fig. 4. Turn boat over. Taper the one end of each Chine piece ($\frac{1}{8}$ " x $\frac{1}{8}$ " spruce) for $\frac{1}{8}$ ". Glue tapered ends together to form two pieces about 29" long. When dry, glue in position on boat, starting at the bow. Place joint in Chine near Frame 6.

Figs. 5 and 6. Soak one half of Bottom 15 in water for $\frac{1}{2}$ hour to make bend easier. Clamp in position on Frame and allow to dry. Place clamps near Frames. Repeat for other side. Sand both halves of Bottom to obtain tight joint at center. Glue $\frac{1}{2}$ of Bottom covering only $\frac{1}{2}$ of Frame 6, in position. Clamp and dry. If top of Sheer does not remain flat, clamp boat onto the table. Glue on the other half of Bottom. Glue rear part of Bottom 16 to Frames 6 and 7 and to Transom, Chines, and Keel.

Fig. 7. Sand part 17 to fit from Frame 6 to bow. Fit to Chine. This can be done dry. Glue in position, clamp and dry. Fit the other side and glue in position.

Fig. 8. Soak rear side part 18 in water 15 min. Bend slowly and clamp lightly on Frame allowing slight gap between

(Continued on Page 49)

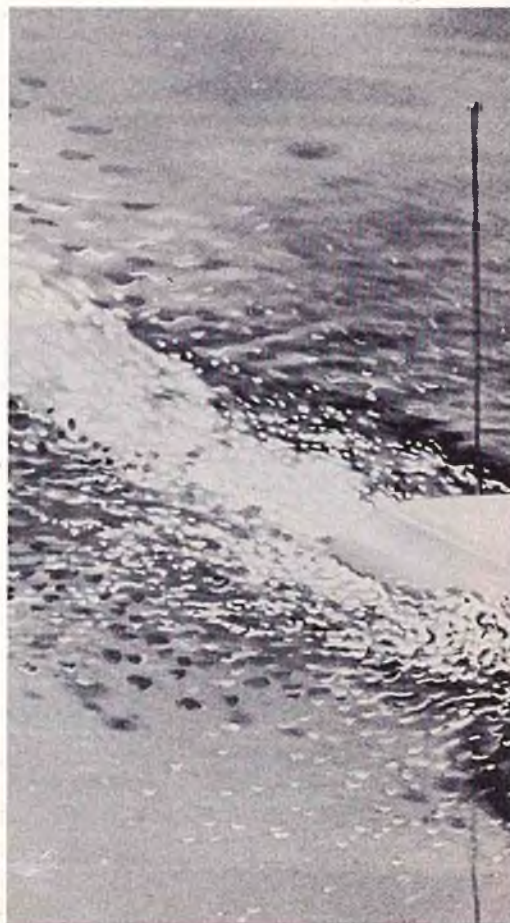
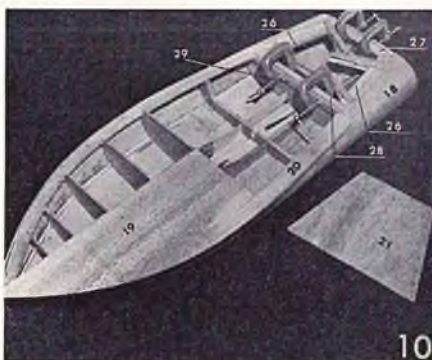
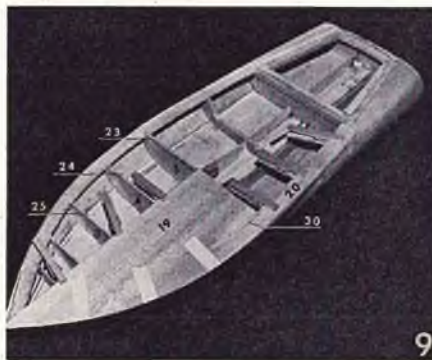
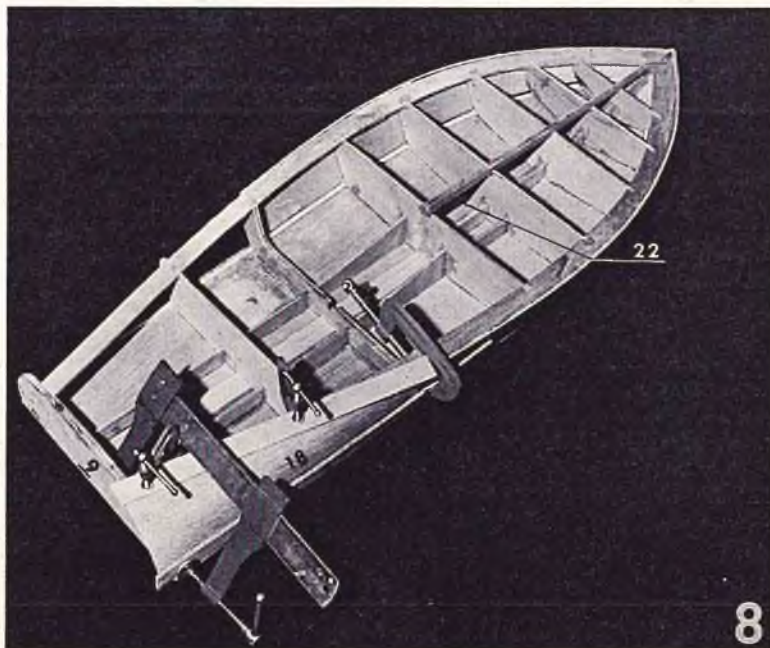

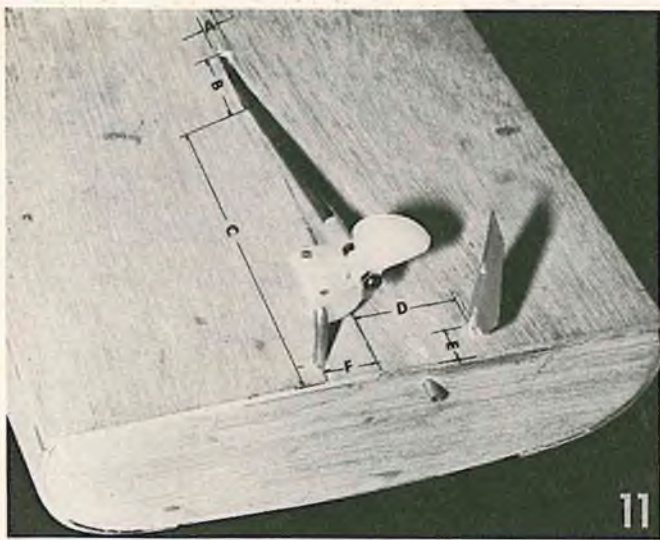

11

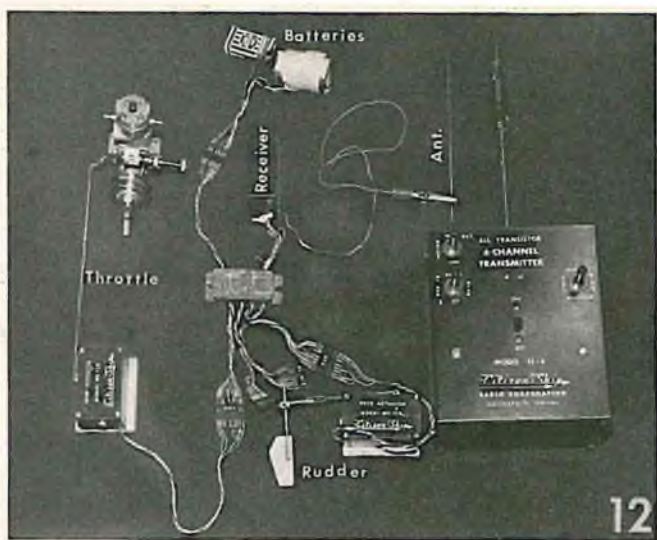

12

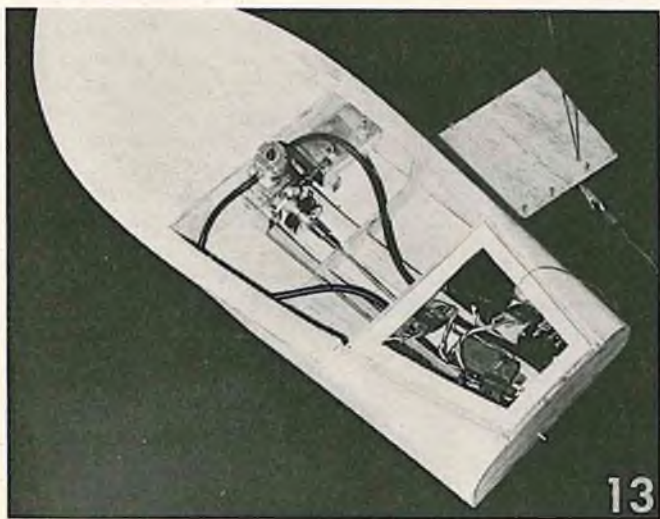

13

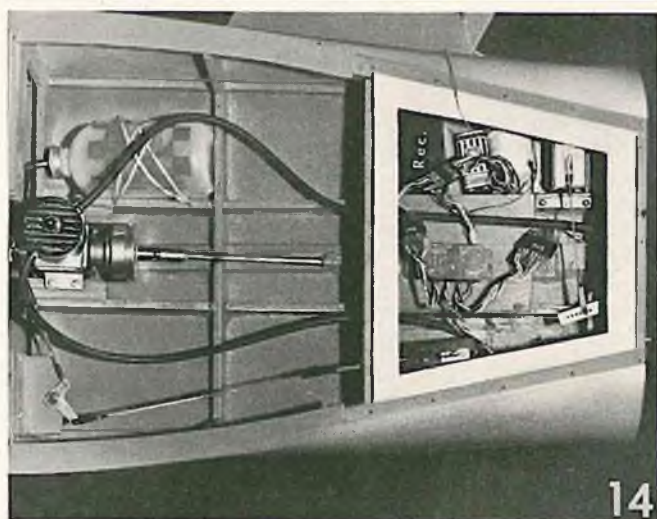

14

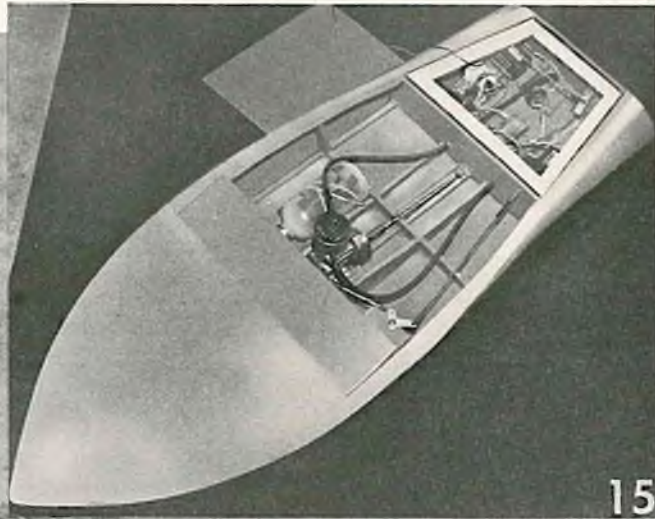
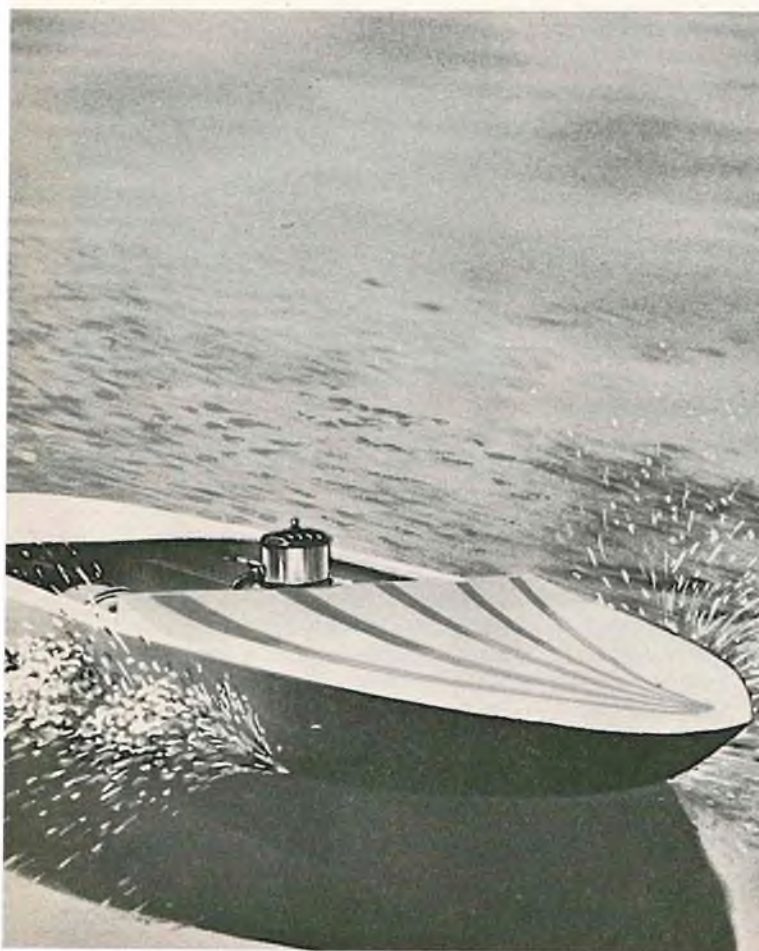

15

TOP OUT

BY JERRY KLEINBURG



IN this column you will read of the contest held in Baton Rouge on the 21st and 22nd of August. The coverage is, in a way, what's normal for a fine meet, reflecting its highlights in terms of usual interest to our readers. It occurs however, that a separate event happening at the same time, cast a fleeting shadow over the flying, and therefore deserves attention in this special way.

As you may recall, Gemini 5 was also launched on the morning of August 21. Although unlikely, it was possible for Cooper and Conrad to look down upon our RC efforts as they could look upon the efforts of millions of people who passed below. As we flew that morning we gave brief passing thought to their tremendous space feat and then went back to concentrating on procedure turns, vertical 8's, etc., of the ground level competition. Aside from being proud they were 'our guys' going after new records we saw no relation to our flying the theirs. However, a careful reading of the accounts of the space event shows we do share a common point of interest — not a large one but enough so that we could perhaps claim the attention of the space twins as they flashed overhead.

What I'm referring to is that small item in the records stating that representatives of the NAA were on hand to certify to the FAI of the space achievements of the flight. They were there to assure recognition of the event through established organizations and procedures familiar to AMA'ers. So, in a way then, we were 'partners,' since RC'ers work within the identical framework to create and support the records of our hobby.

Besides the records, of course, AMA affiliation binds our efforts together; makes possible the means of flying — sport as well as competition — and gives us a foundation of common understanding and purpose. Without an AMA we would at best, splinter into small, confused, and apprehensive groups, quickly losing what's been gained and with little hope of progress in building the status of aero-modeling. As the time for renewal comes up it should be remembered that in a supported AMA, we — meaning you and I — have national identity and unity with international recognition. And besides, we can even

say, "Those astronauts? Yeah, we belong to the same outfit!"

EXPANDING OPPORTUNITY

This is the optimistic forecast for RCing across the country as more and more communities look to radio modelers to provide a dynamic addition to annual city and county celebrations, fairs, festivals, and similarly sponsored civic activities and promotions. While the idea of such use of RC flying is not new, it is one that's taking on expanded dimension as leisure-time America, searching for added expression to vacations and holidays, seeks it as spectators to this hobby-sport of ours.

As a consequence, established annual contests are merging with community projects, or new meets are being created during this period. Miami's King Orange and the Pensacola Fiesta of Five Flags are prime examples of contests that are prominent among modelers. New meets are taking shape during Baton Rouge's Fundora Time as well as the Aqua Festival week in Austin, Texas. In addition, increased RC demonstrations and contests are appearing in conjunction with observation of Armed Forces Day at defense installations in various areas, notably at Albuquerque, Hanscom AFB, Mass., and Seattle, this year.

As in any other opportunity, this one also requires the usual enterprise and initiative to develop full potential at any given place. Success in one area is no automatic assurance of success, or even acceptance, in another place. Although it's becoming easier to gain initial attention due to the general RC awareness that's growing, RC promoters and clubs must still conscientiously 'sell' their uniqueness as well as demonstrate deliverable dependability. Fortunately, among aero-modelers, RCers have "built-in" advantages on both these points. We can tolerate wide latitudes in weather, equipment is now developed to highly predictable levels, flying is confinable to space that's practical for viewing, and the flying is realistic.

Where are possible community projects offering new RC prospects? In anticipation of this question, a small sampling of what was going on (as of this writing in August) was made, and this is what turned up:

Gallup New Mexico Indian

Celebration	Aug 12 - 15
Ligonier Pennsylvania Highland Games	Aug 29
Lake Shore Park (Chicago) Water Show	Aug 14 - 15
Bartlesville Oklahoma Aerospace Day	Aug 31
Santa Fe New Mexico Fiesta	Sept 3 - 6
New Glarus Wisconsin Alpine Festival	Sept 4 - 6
Allentown Penn. Dutch Apple Party	Sept 5 - 6

While it's obviously too late this year for development of any of these, they do offer interesting samples of the diversity available for RC consideration. Remember, this is only a short quick look at a couple of weeks — think how the total across the country must add up! A check with your Chamber of Commerce is usually the best place to start — it should put you in touch with their future plans. If you are "big city" folks, try the smaller surrounding towns too — they are trying to compete these days and are highly receptive. All in all, you may be in for a pleasant surprise. . . .

THE CONTEST SCENE

News from Jacksons Mill (W. Va.) tells of Miles Reed maintaining his Nats momentum by taking first in Class I. Miles — a double trophy winner in Philadelphia this year by virtue of winning third place as well as highest total point honors — has been competing for five years and has a room full of trophies as evidence of his ability.



Miles Reed poses with his vast array of trophies, including a double take at Philly, garnered in Class I.

Flying his Max 50 and 3+1 equipped five footer, Miles is a member of the Canton, Ohio RC Club competition team. He takes contesting seriously since continued performance and top ability must be maintained to be elected by the club membership to that honor. The club annually picks their two best in Class I, plus two in Class III to comprise the team. Competition has

(Continued on Page 55)

SUNDAY FLIER



By KEN WILLARD

PPOT shot pot pouri. Summer always brings an increase in flying activity, especially with the Sunday flier crowd. So here's a few items.

First, as I promised, here are a few hints on flying in a restricted area, using rudder and "kickup" elevator as provided by the Babcock Mark II or Bonner super compound escapements.

Say, for instance, you get permission to use a parking lot in an industrial area on Sundays, when the lot is normally clear. Maybe the lot is about 125 feet wide and 300 feet long. You've built a "Good Neighbor" and would like to use the convenient lot rather than drive to the outskirts of town. Fine. But first, practice in the open area. Set out markers to simulate the boundaries of the lot.

You've gone through all the process of balancing and adjusting the model so that it flies properly. In this regard, you should adjust the rudder for a slight left turn in flight, both under power and in the glide.

Next, and this is important, only fly in restricted areas when there is little or no wind, a fairly common condition in the early morning or around sunset. If you plan to fly in the early morning, make sure you don't antagonize any nearby residents, or you've lost the site before you really had it! It's best to wait until evening, unless the area is completely industrial without a residential area nearby. The wind, however, must be way down, or your precision landing might wind up scraping a building. The launch is not quite so critical, since you have power with which to work.

So here's the flight pattern. Locate yourself about midway of the field length and off center to your right, about 30' from the edge of the field. This will give you about 100' to your left in which to reach the other side of the field.

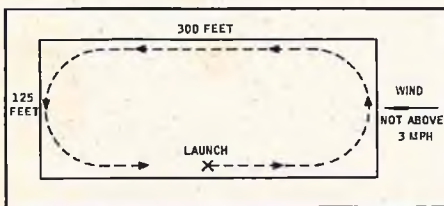

Note that if the wind, even though slight, is blowing across the field, rather than lengthwise, you go to the downwind side. That's so your all-important first turn is made into the wind. If the wind is blowing lengthwise, you launch directly into it.

And why a left turn pattern? Simply because the sequences of the escapement as normally used, makes it possible to do tight "flipper" turns very quickly to the left. Here's how.

Launch the model straight and level. As soon as the prop takes hold the model will start to climb out. After it has gone about 75-100 feet, give two pushes on the transmitter button for left rudder. Hold the second pulse until the model has banked well over into the turn and the nose has dropped from the slight climbing altitude to level or even slightly down.

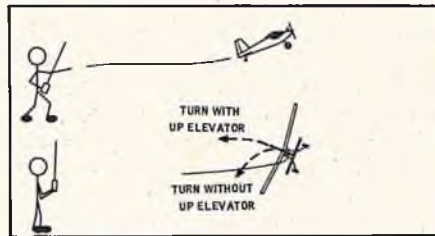

At this point, let up on the button for an instant and **immediately** press it down again and hold. This will release the rudder from the left position and only permit the escapement to rotate to the next stop, which is "up elevator." Now, since the model is banked well over, the elevator action has two results, it tightens up the turn, due to the horizontal component of the elevator force, and raises the nose due to vertical component. So you wind up with a tight, climbing turn, just what you want to bring the model around and head it back into the flying area.

Now the next step is equally important, and that is to let up on the button before the model comes around too far, or the nose gets too high and a stall results. This timing will vary with each model, so you'll have to practice it until you are able to complete the turn in a gentle climbing altitude, headed down the field.

If you have quite a bit of throw on your rudder and elevator linkages, these

things happen quite rapidly. The rudder can warp the model over into a near vertical bank, and then when you apply elevator, you get a **real** "flipper turn!" The elevator, being nearly vertical, actually is acting as a big rudder in the horizontal plane. Pylon racers use this technique when they are "pylon polishing."



Back to the small field flying. Now that you've made that first turn, let the model fly the length of the field. By this time it should have climbed above any light standards or telephone poles and you're up in open sky. If not, then another "flipper turn" at the other end of the field and back up the field should do it.

Once you are up in open sky your problems with obstacles are over until the engine quits. Then you've got to come back into the small area. This takes a little doing, but it's a lot easier if you plan it.

First you should know the approximate length of your engine run, and as the time approaches for the engine to quit, get the model just about overhead, and above the obstructions. Usually about 100' of altitude is more than enough.

Now, when the engine quits, the model is likely to glide about 600 feet forward (6.1 glide ratio), and you've got to get in a field 300 feet long.

Head the model into the wind and glide it to the upwind, right hand side of the field.

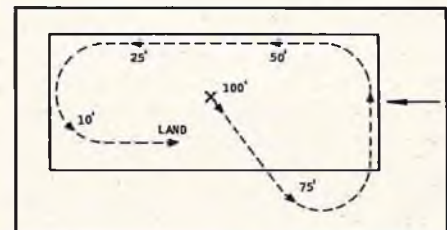

As it sinks, and approaches any perimeter obstacles, bring the model inside the field boundaries, then make the left turn at the upwind boundaries. By now the model should be about 50' high.

Glide downwind until you can see that another 180 degree turn will bring it around into the wind with just a few feet of altitude. This last turn can be made by the rudder, followed with a short pause on the button in the third position, which will bring the nose up slightly (don't hold too long, just

(Continued on Page 62)

**IMPORTED LIGHTWEIGHT
SILK — NYLON**
FOR
Model Covering

SILK White, Red, Yellow, Orange, Blue, Green, Purple, Navy, Black, **ONLY**

NYLON White, Yellow **\$1.10 per yard ONLY**

NYLON Red, Orange, Blue, Gold **\$1.00 per yard ONLY**

PACKAGING — ONE YARD OR TWO YARDS TO AN ENVELOPE OR ANY OTHER LENGTH DESIRED

CHECKERBOARD SILK ONLY
Red & White
Black & White **\$1.29 per yard**
One yard squares only

IF NOT AVAILABLE AT YOUR HOBBY DEALER SEND DIRECT
MODEL COVERING CO.
2320 OCEAN PARKWAY, BROOKLYN, N.Y. 11223

**UP TO 50% TRADE-IN
NEW R/C EQUIPMENT
AND MOTORS**

READY-TO-FLY SPECIALS

- 10 Channel Taurus Orbit Superhet, Medco Pack and Chargers. S.T. 51 R/C. 5 Transmites. All New **\$500.00**
- Falcon 56, Min-X 12008 Pulse-mite and Superhet Receiver. O.S. 15 R/C. Go-Ac. Flyable. All Wired **\$180.00**
- P-63, Orbit 12 Set, 5 Transmites, Medco Pack and Charger, O.S. 50 R/C. Wired and Flyable **\$500.00**
- P-61 Mustang, 5 Annco's, Medco Pack and Charger, Dean's 12 Set (Superhet), K&B .45 R/C. Will Fly **\$500.00**
- 58" Tri-Pacer Orbit 6 Superhet Set, 3 Transmites, Medco Pack and Charger, Veco 35 R/C. Test Flown **\$325.00**
- Skylark 56, 3 Annco's, Medco Pack and Charger, Veco 19 R/C. 6 Ch. Superhet Citizen-Ship Multi-Train-er **\$300.00**

NEW SPECIALS

- Citizenship APS System Complete .. \$166.66
- Citizenship 10 Ch. SH Set (\$199.95) .. \$129.95
- Citizenship 6 Ch. Set SH (\$119.95) .. \$ 77.77

GOOD USED TRADE-INS

- 10 Ch. Orbit relayless R&T Set \$75.00
- 5 Ch. F&M Set & 2 Duramites wired .. \$50.00
- 6 Ch. Citizenship like new \$50.00

ALL ADVERTISED BRANDS IN STOCK
SEND 10c for Bargain Bulletin

NASHVILLE HOBBY CENTER
903 Church Street
Nashville, Tennessee

CHANGE OF ADDRESS

Attach magazine label here

If you're moving, please let us know six weeks before changing your address. Place magazine address label here, print your new address below. If you have a question about your subscription, place your magazine address label here and clip this form to your letter.

Name _____

Address _____

City _____ State _____ Zip _____

**NATIONAL MINIATURE
PYLON RACING ASSOCIATION**

P. O. Box 487 • Sierra Madre • Calif.



The AMA Nationals committee invited the NMPRA to present a demonstration Goodyear pylon race at the Nationals at Willow Grove N.A.S. The invitation was gladly accepted. Due to the complexity of Nationals operation, it became necessary for all NMPRA preparations to be completed in advance. Members were notified of the arrangements, and urged to participate. Plans were formed to make this the first NMPRA Nationals contest, with trophies donated by the NMPRA.

The entries returned promptly, and it was gratifying to note that several members sent contributions, along with short notes, explaining that they could not attend, but wished to lend their support. It is members like these that help make a strong organization.

The Goodyear event was scheduled for Thursday and Friday evenings. Thursday evening, as soon as regular flying had ceased, everyone headed to the extreme end of runway 24, where the race was to be held. The first to arrive were greeted by an irate Marine Lieutenant, who insisted that no one was allowed in the area, let alone any ideas of flying. The thought of cars descending on the area by the hundreds, only made matters worse. For a short while the situation seemed hopeless, but finally, through the aid of the AMA, clearance was obtained to hold the event as scheduled, though a little late.

Qualifying flights were made, being run in heats of three ships each, primarily for the benefit of the spectators. The multiple qualification heats also reduced the time required, and gave an indication of the fliers reactions under close flying conditions.

The best qualifying times were turned in by Cliff Weirick (2:35:9) flying

Maurice Woods' Long Midget, and Jim Kirkland (2:39:6) with a Scale Shoestring. Cliff and Jim, qualifying in the same flight, certainly gave a crowd pleasing performance, as each tried desperately to shave precious time on the turns, flying the entire course practically wing tip to wing tip.

On Friday evening, with all of the qualifying times recorded, the race teams were positioned, based on time, handicap and equipment frequency. Kirkland's excellent Shoestring earned him a 27 second lead. This high handicap, plus the fast qualifying speed seemed to indicate a tough competitor.

Words cannot describe the thrill and excitement as these tiny racers whizzed around the course, cutting as close to the pylons as possible. Even a light rain, which threatened to become a down-pour, could not dampen the spirit of the fliers, or of the crowd of spectators.

The last race pitted the four finalists, Kirkland, Ray Downs, Weirick and Don Coleman for a spectacular climax. Kirkland's engine quit on take off. A quick retrieve and start and Jim entered the race three laps behind the last ship. As Weirick and Downs jockeyed for lead position, Coleman fought to maintain a lead over Kirkland, who was steadily closing the gap on third place. By the eighth lap, Kirkland was only one lap out of third.

Cliff Weirick crossed the finish line for first place, followed closely by Ray Downs in second place. Kirkland continued to press Coleman for third position, passing him in the tenth lap for third place.

The NMPRA trophies were presented to the first three place winners, with

(Continued on Page 48)

A beautiful Aeolus from RCM plans by Larry Roberts of Vashon, Washington.



Another outstanding example of Goodyear interest — This time a West Coast entry.



WOODCRAFT DURANITE:

Newest Entry in the "NEW ERA" of Materials for R/C

ONE of the newest construction materials available to the R/C enthusiast is Duranite, a material that is conversely, as difficult to describe in print as it is easy to work with in actual construction.

Basically, Duranite is a "plastic-like" material with none of the unfortunate connotations usually attributed to plastics insofar as our applications are concerned. Our introduction to the new product came in the form of three R/C aircraft kits from Jack Blything of Woodcraft, 7521 Menaul, N.E., Albuquerque, New Mexico. The first was the El Tigre, a competition multi aircraft; the second, a prototype of Woodcraft's "Rivets" Goodyear Racer; and the third, the Early Bird, a shoulder wing design for training and sport flying.

The El Tigre fuselage was completely moulded of Duranite. The wings were foam cores covered with .012 Duranite sheet, as were the fin and stab. Both of the other kits were furnished in the same fashion, all complete with hardware and balsa capping necessary to seal off any exposed foam at hinge lines, etc. The Duranite foamed fuselage was extremely smooth, with the exception of the fuselage lap-joint seam, which is easily trimmed and sanded. There are no seams on any other part of the plane. The wings were very light, the skin material imparting such a gloss that it was almost impossible to photograph. As mentioned, trimming and sanding the Duranite material is quite easy, although the strength and flexibility of the material is phenomenal. By actual test, a one mil sheet has a factor of 8-12,000 P.S.I. 470 pounds of pressure was necessary to continue a tear already started, while it was impossible to measure the force necessary to start a tear in the material! The Duranite was flexible, and evidenced no tendency toward fracturing or brittleness through a wide range of temperatures.

Insofar as adhesion is concerned, we noticed no evidence of the wing skins attempting to part company with the internal foam cores. Wing butt joints, or balsa to foam joints, are made either with epoxy cements or white glue, although neither of the above will adhere to the Duranite itself. In the case of the latter, where Duranite is to be glued to

itself, or to wood, Testor's regular model airplane cement proved to be an outstanding bonding agent. In areas of extreme stress, such as the area where the motor mounts joined the fuselage sides, we added a layer of thin Celastic which adhered beautifully to the fuselage material, and gave us a clue as to at least one material that could be used for repairs, should they become necessary.

Both the Duranite fuselage and laminated core assemblies should be sanded with a large sanding block, prior to painting. HobbyPoxy Stuff was used, with excellent results, for smoothing out the seam joint. AMT Customizing Body Putty, intended for slot car usage, was also tried for the same purpose, with equally good results. Insofar as painting is concerned, we tried both acrylic lacquer and common "hardware-store variety" enamel with complete success. The acrylic lacquer is available in all of the exotic colors used on today's custom automobiles at local auto paint shops. Be sure to use the primer and sealer recommended with the brand selected. Drying time was quite fast, and the resulting finish was fuel proof and of the highest caliber. Spray cans of enamel were also used, with gray hot rod primer being used as a base. Again, results were far better than average. A word of warning, however—don't use black or navy blue, since they absorb heat and create a softening of the material underneath! No other colors presented this problem. HobbyPoxy will not adhere to Duranite unless a lacquer primer is used as a base-sealer.

According to the manufacturer, Duranite is also being made available in 33" x 60" sheets, along with two types of cement, as covering material for use by RC'ers in covering foam wing cores. The material provided is ample to cover a standard multi wing, stab, and fin, and weighs 13 ounces.

Our "Early Bird," when completed, weighed 6 pounds, ready to fly with Kraft Proportional installed. Wing span of the model is 60" with an overall area of 700 square inches. Length is 46¾". Designed as a multi trainer for .35-.45 mills, the "Bird" is equally at home with, or without ailerons. Simply lock the

(Continued on Page 49)

FASTEST GROWING HOBBY CENTER

IN NEW YORK CITY

WE WILL NOT BE UNDERSOLD!

\$\$\$ \$ SAVE \$\$\$ \$

OUR EXPANSION HAS ALLOWED US TO BRING YOU THE LOWEST PRICES ON ALL LEADING R/C EQUIPMENT, INCLUDING MULTI—ALL IN STOCK, ALL BRAND NEW—OR TELL US YOUR NEED AND RECEIVE OUR LOW QUOTATION —

\$\$\$ \$ SAVE \$\$\$ \$

IN THE MARKET FOR MULTI PROPORTIONAL? CHECK OUR PRICES FIRST! In Stock Now!

BONNER DIGIMITE, ORBITROL CITIZENSHIP A.P.S., DEE BEE QUADRUPLEX AND OTHERS

Citizenship A.P.S.—Way Less Than \$200

We will BEAT any price!

Citizenship 10 Channel—\$130

SEND FOR NEW PRICE LIST OUR 13th YEAR OF SERVICE

Brown's Hobby Center

6031 BROADWAY, BRONX 71, N. Y.
One Block North of 242nd St. El. Station
OPPOSITE VAN CORTLANDT MANSION
KI 8-5422

All Brands of Merchandise in Stock

BOATING
at its **BEST**

Fibre-glass model boat kits for speed & sport



"Super Challenger"

All fibre-glass—strong and durable. The Super Challenger is 41" long, 20" wide, and weighs approximately 12-14 lbs. when completed. For the competition or sports-minded model builder. The Super Challenger has been timed

at 37.4 seconds for the ¼ mile I.M.P.B.A. oval. Complete kit—plans and instructions only ————— \$49.95

"Tas" Engine



High torque • recoil starter • 18,000 volt ignition system • water cooling available • 1.31 cu. in. • 9000 r.p.m. • wt. 5 lbs. 3 oz. • ht. 8½" • For use in the "Super Challenger" • with tool kit and fuel tank only \$41.00

Distributors for Cameron and Tas

Terms — F.O.B. Lombard, Illinois — Sorry, No C.O.D.'s. Add 10% to the cost of the order for shipping charges (\$5.00 maximum in U.S.A.). "Terms" as per August 1965 issue of RCM. Dealer's Inquiries Invited.

Complete Catalog 25c

G.E.M. MODELS

48 WEST LE MOYNE
LOMBARD, ILLINOIS 60148

SOLID HAPPY WING CORES

Tested and Recommended by R/C Modeler Magazine

- TRUE
- RUGGED
- LIGHT
- RESILIENT

TYPES — Include Instructions, Precut Dihedral Angle,

Servo and Dihedral Brace Cutouts

BEACHCOMBER	CRUSADER	INTERCEPTOR	CANDY	\$ 15 ⁰⁰
BOSCH TAPER	KWIK-FLI	TAURUS	ROBIN	
SWEPT TAURUS	KWIK-FLI II	CITRON	VIPER	
L.G. Mounts Included with Above				

FALCON SR.	JENNY	*ARISTO-CAT	\$ 12 ⁰⁰
*FALCON 56	STORMER	*No Servo Cutout Unless Requested	

MATCHING STAB CORES (Except Robin & Viper) \$ 4⁷⁵

We highly recommend GLAS KRAFT fuselages as a perfect mate for our Robin, Candy & Viper wings.

NEW IMPROVED "KWIK STICK"

Foam-Balsa Contact Cement. Pt. now \$2.50

Heat Shrink Tubing — 3/4", 1/2", 3/8" ----- ft.	.25
Non-stretch Brake Cable ----- 10 ft.	.75
3/4" Nylon Hinge Material ----- ft.	.25

Satisfaction Guaranteed

CUSTOM  PRODUCTS

1205 green acres rd. metairie, louisiana
ph. 504-835-7447 zip code 70003

Jim Kirkland Stan John Bob Lien Les Sanborn

AT LAST!

A SUB-MINIATURE FLASHING BEACON "LI'L BLINKER" Pat. Pending

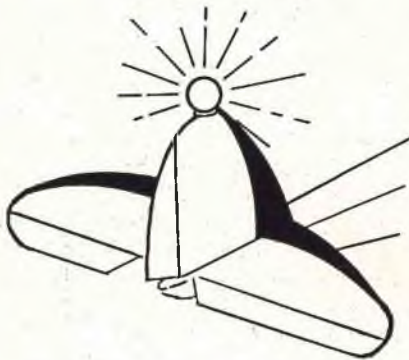

- Never lose your model again.
- Ideal for R/C. FF, Scale, U/C
- Blinks on and off over 8 hours steady on 2 pen cells
- High-intensity light may be seen for 1/2 mile.
- Mounts anywhere. Can be triggered by servo, escapement, timer or continuous.
- Complete with spring-loaded actuator switch, mounting hardware and fuel gasket.

AFFIDAVIT

"On July 11, 1965 I experienced a fly-away of my Class II aircraft on which I had mounted a LI'L BLINKER. After a two-hour search, one of my friends spotted the little flashing light in the branches of a pine tree. The LI'L BLINKER is the best investment I have made. I'll never fly without one again."

Signed _____

AMA 4554

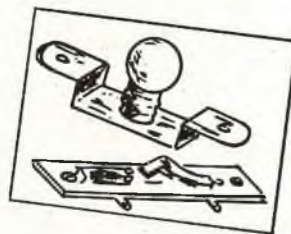

Size: 3/4" H x 1 1/4" L x 1/2" W
Weight with Switch: .04 oz.
(less batteries)

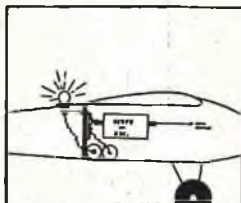

R/C...use equipment installed.

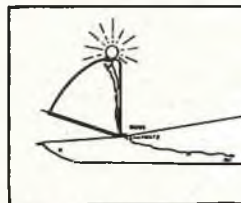

F/F...dethermalizer or timer activates unit.



Run your boats at night

FLY WITH CONFIDENCE —
Order your "LI'L BLINKER" Today.

SEND CHECK, CASH OR MONEY ORDER. NO C. O. D.

DEALERS WRITE

Angel MINI-FLITE CO.

Box 437
FITCHBURG, MASS.

\$3.95
less batteries

N.M.P.R.A.

(Continued from Page 46)

the perpetual trophy going to the team of Weirick and Woods. Don Coleman, placing fourth, was presented by Sterling with a Denight Special kit.

The Goodyear event was certainly a hit with the spectators, largely Nationals contestants in other events, and also with the participants, many of whom had never entered a race before. We feel that the event was also a hit with the AMA officials, who turned out to see what this NMPRA was all about. We do fly safely, and this is **not** a hazardous or dangerous event!

One final word about the members who sent contributions. Obviously, they expect no praise, but we feel that their generosity and support should be recognized, therefore we would like to express our appreciation to — John Burris Jr., Sam Crawford, Joe Doehler, Elmer Hubbard Jr., Bill Zajichok, Anthony Zablocki and BJT Products Inc., along with all those who participated, as fliers, flagmen, timers, directors or spectators. How about you? Have you joined the N.M.P.R.A. yet?



"Hey —! It says, if found, return immediately to Don Dewey, R/C Modeler Magazine, Sierra Madre, California, and collect substantial reward —"

PRODUCT REPORT

(Continued from Page 47)

aileron in place until you gain confidence in your own flying ability. Increasing the power on the "Early Bird" to a .51 or .56 will give you a ship that is really a bomb! Flying characteristics are similar to a Flat-Top Stormer.

The El Tigre is for the advanced Class III pilot, and is designed for competitive flying, or for sport flying for the RC'er with full-house experience. It is a very fast ship with an excellent roll rate.

Woodcraft, as many of you know, was the first to provide a foam core wing with hardwood veneer covering. Jack Blything stated to RCM that they had heard of a couple of the wings where the sheet was apparently lifting from the cores, due to moisture infiltration or other adhesion problems. Any modeler who purchased a Woodcraft wing and experiencing this difficulty may return one-half of the wing as proof of such a condition, and will receive in return, an entire wing covered with Duranite. Moisture conditions are not a problem with the new material, since we found that the completed wing could be completely immersed in water with no difficulties whatsoever.

Flexible, strong, fuel-proof, easy to work with — this is how we would classify Duranite . . . a new "space-age" material designed to the exacting requirements of the R/C Modeler.

SK DADDLE TOO

(Continued from Page 42)

part 18 and Transom 9 to allow for shrinkage of wood. When dry, glue and reclamp. Repeat for other side. When dry plane and sand edges of bottom even with sides. Glue two center Deck Stringers 22 in position in notches on top of Frames.

Fig. 9. Sand sides Part 17 even with Sheer 10 so deck will fit. Glue one part 23 on top of each side of Frame 5 and to Deck Stringer 22. Glue part 24 on top of each side of Frame 4 and part 25 on top of each side of Frame 3. Taper pieces on top of Frame 3 and 4 with sand paper, from center to edge of boat. **DO NOT TAPER** 23 top of Frame 5. Before putting on the deck run glue along all joints, frames, chines, and bottom. Give the inside of your boat, from Frame 5 forward, several coats of a good bakelite base Spar Varnish to seal the wood before gluing on deck. Fit Deck 19 and glue in position. Hold with clothespins and masking tape. Glue Deck at sides of Frame 5 down on Sheer 10. Notch part 18 so deck side 20 can be glued to Sheer 10. Glue Deck Side

(Continued on Page 52)

Another DU-BRO R/C First!

NEW LOW BOUNCE SHOCK ABSORBING WHEELS

Introduced and used at the '65 Nationals. Permanently Pneumatic. Same strong unbreakable Du-Bro Dura-Hub.

1 3/4"	\$2.19 pr.
2"	2.39 pr.
2 1/4"	2.59 pr.
2 1/2"	2.79 pr.
2 3/4"	2.99 pr.
3"	3.19 pr.
3 1/4"	3.39 pr.
3 1/2"	3.59 pr.

Also available in "SLICKS"

2 1/4"	\$2.59 pr.
2 1/2"	2.79 pr.
2 3/4"	2.99 pr.
3"	3.19 pr.



Regular line of Du-Bro wheels are still available.

Coming Soon . . . DU-BRO INSTANT ACTION ELECTRIC BRAKES

DU-BRO PRODUCTS 7667 N. Milwaukee Avenue
Niles, Illinois 60648

✓ TESTED, APPROVED, AND RECOMMENDED
BY R/C MODELER MAGAZINE



2" Scale - 72" Span
.49 - .65 Engines
Fully Cowlid

An Acrobatic Scale Model for Multi RC

- Fiber glass cowl
- Complete landing gear
- Jig built sheet fuselage
- Key constructed wing
 - 33 sq. ft. drawings
 - 100 custom finished sig balsa & ply parts
- No carving or planking

California Residents add 4%.
Dealer Inquiries Invited.
Send stamp for free literature.

Custom Crafted Kit 36.95
Plans & Templates -- 5.00
Fiber Glass Cowl --- 6.00

JACK STAFFORD MODELS
12111 BEATRICE ST.
CULVER CITY, CALIF.

Second edition
of Kalmbach's

R/C PRIMER

by Howard G. McEntee



R/C PRIMER has been extensively revised, and is not just a reprint. Many exciting and up-to-date photos, revised text, new colorful cover. This book is exactly what the cover indicates, a primer for the radio-control enthusiast. R/C Primer thoroughly discusses frequency and licensing information, control systems, transmitters, model boats, components, installations of R/C systems, field tests, maintenance and troubleshooting. The price is still \$2.00.

AL YOUR HOBBY SHOP — OR

Kalmbach Publishing Co., 1027 N. 7th St.,
Milwaukee, Wis. 53233, Dept. 4832

Enclosed find \$2.00. Send postpaid your second edition of R/C PRIMER.

Name _____

Address _____

City, State, Zip _____

FOAM-LYTE . . . The Finest in Foam Wing Cores!

- ✓ Expanded bead type foam of 1 lb./cu. ft. density formed into 4 ounce solid core panels.
- ✓ One piece solid maple hardwood landing gear assembly.
- ✓ All inset aileron pushrod cutouts pre-formed.
- ✓ Landing gear spar assembly slots pre-formed.
- ✓ Choice of 45 degree or square pre-formed wing tips.
- ✓ Pre-formed leading edges in choice of $\frac{1}{16}$ " or $\frac{3}{32}$ " contest type balsa.
- ✓ Accurately pre-formed dihedral.

FOAM-LYTE CEMENT . . .

. . . THE PERFECT COMPLEMENT

Foam-Lyte Cement is a contact type cement that can be used on both expanded bead or regular styrofoam . . . used to laminate foam to foam, wood to foam, or wood to wood. Extremely light weight, this rubber base adhesive will provide a permanent bond that cannot be broken without destroying the laminated materials. Completely resistant to dope and thinners when dry.

— \$2.80 pint

FOAM CORE BLOCKS: 1 lb./cu. ft. 3"x16"x36".
\$3.80 ea. Enough for a 700 sq. inch wing.

Custom wings cut to order. Furnish wing plan with all specifications.

CANDY • TAURUS • KWIK FLI II
CHEROKEE • PATRIOT • CUSTOM
LOW WING CORES — \$12.95

(\$1.50 less if L.E. not desired)

SENIOR FALCON • JENNY
FALCON 56 • TAURI
CUSTOM HIGH ON SHOULDER
WING CORES — \$11.95

(\$1.50 less if L.E. not desired)



WHO SAID FOAM WINGS AREN'T VERSATILE?



Phil Garrard's new Vampire
Delta with Custom
Foam Wing Core
by FOAM-CRAFT



Dealer Inquiries Invited. Check, Cash or Money Order.
Sorry, No C.O.D.'s. California Residents Add 4%.
Tested, approved, & recommended by R/C Modeler

**FOAM-CRAFTS
MANUFACTURING**



P.O. BOX 336 • CAMPBELL, CALIFORNIA

ERTAIL and RCM who never have enough pictures of boats. If you would like to see pictures of the boats that are setting the records, then vote yes for the proposal on the next ballot. This is what ballots are for. Exercise your right to vote on matters which concern model power boating. If you are not a member now, get your application in, or send for an application to the General Office.

This is also your reminder that the ballots are due back to the General Office by December 1, 1965. The deadline of course is timed so that all issues and elections will be effective on January 1, 1966. There are two ways to consider your ballots. One, by far the best, is to read the ballot when you get home from work, think about it while you have dinner, talk it over with any interested parties, read the proposals once again and get the ballot in the mail the next morning. The second approach is to read over the proposals, form an opinion, then take the proposals to the next club meeting, where each measure can be talked over. After hearing the pros and cons of each man voicing an opinion, make up your own mind and send the ballot the day following the meeting. The issues are decided by a majority of the ballots returned to the office. By holding yours past the deadline you not only lose your vote, but increase the voting power of those who sent ballots to be counted.

At the business meeting held in conjunction with the annual regatta in Cape Coral, it was proposed that we change Procedure V, Section 1, G2 and no longer require that the annual regatta include both R/C and Tether. This would relieve the host club of the task of running a meet for which it is

neither prepared, or experienced. Instead it is suggested that the R/C and Tether Divisions have separate regattas. For example, we run no tether at all in the Skippers R/C Club. It would be foolish for us to attempt to conduct a meet which included tether racing. Likewise it would be folly to have the New York Model Power Boat Club, which is strictly tether, attempt to run a meet which included R/C competition. There are clubs all over the country which could easily host one meet or the other, but would not even attempt to conduct a meet which included both tether & R/C. With this in mind, bids are now being accepted for the 1966 Annual IMPBA Regattas.

For many years, the number of meets at which records may be set has been a point of conjecture. As the rule now stands, there is no limit to the number of dates which can be sanctioned for record attempts. Any club may request as many dates as it desires. All requests have been granted thus far, unless they interfere with an invitational regatta in the same general part of the country.

One of the outgrowths of the "no limit" rule on sanctions is that some clubs have asked for "every Sunday sanction" during the normal running season, except those days which interfere with invitational dates. This forces the rule to be "bent" in such a way as to allow weekly record attempts by clubs which are relatively close together. Also, these meets are not necessarily attended by members of other clubs, which could leave doubt in the minds of some as to the conditions under which the records were set. To bring sanctioned regattas, and record meets back

into their proper place, with equality of opportunity for all concerned, it is only necessary for you to support the proposal which permits sanctions to be granted only to bona fide invitational regattas or advertised "run for record" meets. There would be no limit to the number of sanctions which could be granted to any club, but they should not be granted for the same dates as record trials within a reasonable distance, (say 200 miles) from another club holding record trials. In addition, if a sanction is granted for record trials, these trials are open to all members of the IMPBA, and it is the obligation of the host club to provide equipment, timers, and facilities to properly conduct record trials. To fail to provide adequate facilities at any sanctioned record trial meet is to fail to meet the obligation to the participant. A sanction, as you remember is a guarantee to the contestant that there is in fact competition at a specific time and place, and that this competition will be carried out according to the existing rules of the IMPBA.

In order that as many record trials, and meets as possible be scheduled without mutual interference, it is imperative that all requests for sanction be submitted to the General Office before March 1st. This is in accordance with Procedure IV, Section 1-H, in your Handbook of Model Power Boating.

This early request for sanction also permits a contest calendar to be published here in the Roostertail, which will appear in time for members to prepare for the event. In many instances this season, sanctions were requested at such a late date that it was impossible to have them in a contest calendar which would appear in print before the contest date.

WORLD WIDE R/C

WORLD WIDE RADIO CONTROL, the international center for radio control enthusiasts. Here, a group of R/C'ers service flying and boating hobbyists from all over the world.

Every day, mail from Australia to Zanzibar is delivered to World Wide with orders for everything from balsa to wings of foam. Orders are nearly always filled the same day. Service and information flows back to hobbyists quickly and accurately.

Join the R/C'ers who benefit from World Wide experience. If you are not on our mailing list, you should be. Write and ask for the frequently published "Quick Blips" or send along a dime for our latest catalog. Please be sure to include your name, address and zip code.



World Wide Radio Control 10
7845 Wvoming, Dearborn, Mich. 48126



GEE BEE FLOATS

Operate your model off water, turf, sand, snow. Made of lightweight, impact-proof polyethylene. Finished and ready to fly, with hardware included for easy mounting. Attach to any conventional landing gear.

NOW 3 SIZES

19 1/2" for .02 to .074 Max. Model Wt. 28 ozs.	\$ 5.95
28" for .09 to .29 Max. Model Wt. 72 ozs.	\$ 8.95
33" for models weighing up to 8 lbs.	\$12.95

AT YOUR DEALER OR DIRECT
the GEE BEE line
box 347 forest park station
springfield mass

SK DADDLE TOO

(Continued from Page 49)

20 in position and clamp. Make small piece 30 from 1/2" mahogany to cover opening at end of part 23.

Fig. 10. Center Rear Deck 21 in position on rear of boat. Mark along edges and trim rear sides 18 so that deck fits down on Sheer 10 and flush with stern. Fit and glue pieces 26 under Sheer on each side, 27 across stern, and 28 across rear of Frame 7 to make smooth surface for rubber seal. Glue strip 29 across front of Frame 7 to give wider surface for screws. Round top edge of Deck to blend into Side 18. Drill 12 clearance holes in rear cover approx. 1/8" from edge as shown in Fig. 13.

Fig. 11. Instructions for installing Dumas Running Hardware H-2 in SK Daddle Too —

See chart for dimensions.

1. Cut slot for stuffing box.
2. Mount engine on the motor mount rails using lock washers or self locking nuts.

3. Mount stuffing box in strut; attach propeller to shaft; insert shaft in stuffing box.

4. File ends of slot in boat until shaft screws into universal joints and strut fits on bottom of boat without binding.

5. Bolt strut in position so prop is correct distance from rear of transom.

6. Drill hole for rudder shaft.

7. Drill hole for water pick-up tube. Clearance of 1/16" between prop and tube with prop pulled toward stern.

8. Drill hole for 3/8" brass tube for water outlet from engine. Approximately as shown on rear of boat — location not critical as long as you avoid the water pick-up tube and rudder shaft.

	SK-2	A	B	C	D	E	F	G
SLOT WIDTH	3/16"	1/8"	1/4"	5/16"	1 1/2"	3/8"	1/2"	1 1/4"
SLOT LENGTH								
TRANSONM TO RUDDER								
TRANSONM TO PICK UP TUBE								

It would be helpful to pick an engine and running hardware for your boat as soon as possible after buying the boat kit. We recommend a water cooled engine. Several makes of .15 and .19 marine engines are available, or an airplane engine can be used with a cooling clamp.

We have shown typical engine and radio installations. No doubt you will have to make modifications to adapt your particular engine and radio equipment to the boat.

Now for finishing:

A beautiful glass-smooth finish on your boat will really put the finishing touch on it. This will take a little doing on your part.

Here are step-by-step finishing instruc-

tions that will give you that finish.

Wood Preparation:

1. Sand the wood with 3/0 sand paper.

2. Fill any cracks or low spots with material such as plastic wood or Hobby-poxy filler.

3. Fill the grain in the wood with Hobby-poxy filler or regular wood filler.

4. Sand smooth with 3/0 paper.

5. Now you are ready for paint. First it must be hot fuel proof or it will be softened by engine fuel. A good bakelite base Spar varnish, Hobby-poxy or good marine enamel should do the trick. If you are an airplane builder, you may want to use dope. Either spray it or brush it.

6. Do not put dope sealer under Hobby-poxy or enamel.

7. After the first coat has dried sand with 400 grit wet or dry paper, using it with water. Sand boat smooth. Now re-fill all the holes that you missed the first time. Be sure to sand or roughen the holes so the filler will stick.

8. Repeat this procedure 3 or 4 times, or until you obtain the finish you want. Some modelers put on as many as 10 coats.

9. These boats are usually in wild colors with fancy trim. Look at the various pictures of the running models shown in the instructions. These may give you some ideas — it's impossible to make them too fancy.

10. If you want to run your finish for a real satin look, use a fine rubbing compound like that used for automobiles.

Fig. 12. This is a layout of typical radio equipment, showing one actuator for the throttle and one for the rudder control.

Fig. 13. Shows a typical engine and radio equipment installation in SK Daddle Too. Modifications on location may have to be made to fit your particular equipment.

Fig. 14. Now cut and cement rubber around the radio compartment. Use rubber cement or contact cement. Soak decals in water and slide decal off onto side of boat. Hold decal and smooth in place with the edge of a card. Coat decals with one coat of bakelite base varnish to make them fuelproof and to help protect them.

Fig. 15. Shows a motor and radio installation in the SK Daddle. This is similar in both boats. We have not shown wiring of equipment as this is detailed by radio equipment manufacturers.

Now for the fun! Take it out to the lake for its maiden voyage. It won't be long until several others will have the same boat, with same size engine. Then you can have the thrill of racing these boats. Watch around the buoys. That's where it gets exciting with 3 or 4 boats close together. Well, you'll just have to experience it to know what it's like.

KITS AND PIECES

Construction of Sterling's Denight Special was pretty well completed last month, with the exception of the wheel pants and cheek cowls. These were added with little trouble, although a power disc or drum sander is almost a necessity in order to trim the cheek cowls to a good fit with the fuselage. Epoxy glue was used to attack the cheek cowls, and to fill areas of less than perfect fitting. Testors' liquid plastic cement was used to join the wheel pant halves. A small hole was drilled in the rear of each cheek to allow air pressure equalization under varying temperatures (this is a good practice on canopies also).

We chose to adopt our own color scheme as suggested under NMPRA rules. This ruling is intended to avoid the confusion caused by several similarly painted ships flying together. Besides we weren't crazy about the scale color scheme anyway. Be sure to use epoxy or enamel finishes on the plastic parts!

The same F & M proportional system that was used in the Cherokee was installed easily. All four servos were used, utilizing separate controls on rudder and aileron.

Sterling's plans omitted the detail of the elevator "horn." This is simply a plastic or brass eye to accept a Kwik Link, drilled and tapped to thread onto the screw protruding through the elevator, allowing for a variable throw. A complete horn assembly of this type is available from Ellis R/C, Bayshore, New York, for 39c. All controls were adjusted for 1/4-inch travel.

With all of the controls installed, and a Series 64 K&B 35 R/C in the nose, the ship balanced just a shade nose heavy. This was corrected by the addition of one half ounce of weight in the tail (a couple extra coats of dope would have served the same purpose). All up

weight, less fuel, 5 pounds 3 ounces.

The entire ship, wing installed, fit easily into the trunk of the car for the trip to the field, a feature generally only occurring on the trip back! We had some reservations regarding the take-off characteristics of this type of ship on a grass field. The engine was started, and purposely left just slightly rich. The ship was released at full throttle. It veered left, then right, then left again and again. In short order it had made an about face and sped widely at the pit crew who were scrambling in all directions. A check of the landing gear showed it to be straight. Another attempt, with similar results. After considerable checking, we decided that the DuBro wheels that we had used were bulging as the ship bounced, grabbing in the wheel pants. Solid sponge wheels were installed, and finally we got airborne (some left turn tendency still existed on the ground, apparently due to torque). The ship appeared to be very well trimmed, with the exception of a slight climbing tendency, which later experience has shown to be desirable. The controls were carefully checked and found to be extremely responsive, even with the small surface travel. We would suggest even less control movement for the first flights.

A few passes around an imaginary pylon course, and suddenly the engine ceased. Fears that the glide path would approximate that of a man hole cover proved to be unwarranted, although the Denight Special could never be classified as a "floater." The ship assumed a moderately steep glide angle, and rather fast glide, into a bouncy landing. By now we were all somewhat unnerved,

Left: Sterling's Denight Special. Below: The Denight rounding the Pylons.



Radio Control HEADQUARTERS

AMERICA'S HOBBY CENTER 146 West 22nd St., N.Y., N.Y. 10011

RADIO CONTROL EQUIPMENT		Reg.	Sale
CITIZENSHIP TMC TRANSMITTER & 28-10 RECEIVER.....		189.90	129.90
CITIZENSHIP RSH SUPER HET RECEIVER.....		34.95	29.95
CITIZENSHIP SPE TRANSMITTED TRANSMITTER.....		39.95	28.95
CITIZENSHIP TCR TCR TRANSMITTED SERVO (TACHO).....		29.95	19.95
ELECTRONICS TWO FLITE ALL TRANSMITTED TRANSMITTER.....		29.95	24.95
ELECTRONICS SINGLETACTIC COMPOUND EQUIPMENT.....		14.95	9.95
CITIZENSHIP 6 CHANNEL SUPERHET RELAYED OUTPUSH WITH 24-60-1218 SERVO, TCR SERVO(2).....		287.75	129.95
MAFFT RELAY RECEIVER TUBE TYPE.....		29.95	13.95
FOR MINIATURE COMPOUND EQUIPMENT.....		7.95	3.95

Peewee

FULLY TRANSISTORIZED

RECEIVER: 7 VOLT BATTERIES OPER. 1/2" x 3/4" x 1 1/4" TRANSDUCER: INDEPENDENT PENCILS MEASURES: 3/8" x 3/8" x 3/8" COLLAPSIBLE ANT. MICRO SWITCH

\$24.88

BOTH TRANSMITTER & RECEIVER

RADIO CONTROL ACCESSORIES		Reg.	Sale
FAST O LINGS Regular 20p Each...SET OF FOUR FOR		.95	.60
INLINE TRIM BAR.....		.95	.60
1/4" PIM PLUS 8 JACK SET (4 TYPES) 1/4" x 1/4" x 1/4".....		.95	.60
24 FEET FLEA WEIGHT HOOD-WIRE (8 COLORS).....		.60	.38

RADIO CONTROL ENGINES		Reg.	Sale		
ENYA .60 R/C.....	9.95	6.39	McCOY .35 R/C.....	12.95	9.49
FOR 15# R/C.....	14.95	10.99	FOR .59 R/C.....	29.95	29.95

RADIO CONTROL AIRPLANES		Reg.	Sale
DOHRT LIVEWIRE PURSUIT For .28-.40 ENG. 66" WINGSPAN	19.95	14.95	
DOHRT LIVEWIRE CUSTOM For .35-.60 ENG. 66" WINGSPAN	21.95	15.95	
ELECTRONICS LIBERTY 2 For .040-.050 ENG. 40" WINGSPAN	7.95	5.95	
BEWELEY R/C MUSTER For .15-.35 ENG. 48" WINGSPAN	18.95	9.95	

(Send for our NEW R/C Catalog listing everything available in R/C)

CONTROLS 5 RECEIVER KIT \$17.95, ASSEMBLED \$19.95, F&M PINGER RECEIVER \$18.95, F&M ECHO TRANSMITTER \$29.95, INC NICAD CHARGER \$5.95, ASTRO TONE MONITOR \$14.95, ASTRO PEE WEE RECEIVER AND TRANSMITTER \$24.88, ASTRO 33 RECEIVER AND TRANSMITTER \$39.95, R&F UNI-CHARGER \$76.98, CRYSTAL: 13, 237, 26, 985, 27, 045, 27, 095, 27, 149, 27, 189, AND 27, 253 EACH \$2.85 CRYSTAL HOLDERS 25c, FUSEAL SWITCH DPDT \$1.49, NI CAD BATTERY PACK 6V-500 MAH \$10.95, NYLON ACCESSORY KIT, TACHO INSTRUMENTS: 1/4", 5/16", 3/8", 7/16", 1/2" EACH \$1.75, CRESCENT R/C TERMINAL BLOCK \$2.25, WILLIAMS METERS: 0-3 \$3.95, 0-5 \$2.95, 0-50 \$2.25, PENCIL BATT. BOX 25c...

RED HOT BUY !! CITIZENSHIP ANALOG

CITIZENSHIP ANALOG SYSTEM \$239.00 WITH A FREE BONUS GIFT CERTIFICATE FOR \$1.00 MERCHANDISE OF FOUR OWN CHOICE.....

WE ALSO SELL TO DEALERS

HO-AR AGENCY DISTRIBUTORS EVERY REPUTABLE R/C STORE, WE HAVE THE WORLD'S LARGEST INVENTORY OF R/C EQUIPMENT, WRITE FOR OUR SERVICE PROGRAM

WE WILL PAY YOU TO SEND FOR THIS WORLD'S NEWEST & MOST COMPLETE R/C CATALOG

SEND ONLY \$1.00

For Our New R/C Catalog

50% CREDIT

Non-refundable With Your Next Order

HERE IS OUR BRAND NEW CATALOG... PICTURES & DESCRIPTIONS ALL BRANDS BRAND EQUIPMENT ACCESSORIES.....

Order By Mail From **AMERICA'S HOBBY CENTER, DEPT. RCM**
146 WEST 22nd STREET, M. Y., N. Y. 10011

Buy your Transmitter or Receiver WITHOUT BATTERIES

Build your own power pack with **GOULD SINTERED PLATE NICKEL CADMIUM** cells with solder lugs and save up to 50%.

Start saving with RCM's **DIGI-TRIO** using 600SCL cells.

SUBTRACT 15% FOR R/C CLUBS AND AMA MEMBERS

Cylindrical

500 SCL	Pencil	\$2.06
600 SCL	Over-sized pencil	2.21
1.2 SCL	Sub "C" cell	2.85
4.0 SCL	"D" size	5.62



Button

500BHL	(high rate)	..	1.98
225BL	99
225BHL	(high rate)	..	1.33

Nationally Distributed by

POWER INCORPORATED

P. O. Box 132 Minneapolis, Minn. 55440

Send _____

Name _____

Address _____

City _____ State _____

a Dumas model of the famous Rich Hallett "SK" boat

so hot . . . so much horsepower, only Lloyds of London will insure the SK's

SK DADDLE TOO

27½" long • 10½" beam . . . \$9.95

- ★ All die-cut mahogany & mahogany plywood.
- ★ For .15-.19 cu. in. engine

LIKE MORE SPEED? try the SK• DADDLE

36" long • 14" beam . . . \$21.95

- ★ Birch plywood construction
- ★ All pre-cut parts
- ★ For .29-.60 cu. in. engine

- ★ WRITE FOR FREE CATALOG . . . over 30 boats to choose from — including the Historic PT 109 and the Gold Cup Hydroplanes

EASY TO BUILD
2 Brand New Models



satisfaction guaranteed. immediate delivery

dealer inquiries invited

DUMAS

featuring the "hot ones" designed for "go" . . . ideal for show

BOATS

P.O. Box 6093 • TUCSON, ARIZONA 85716 • dept DN

with water proof compartments for radio control

and decided that it would be best to investigate the overheating of the engine while the bird was still intact.

The lower cowling design limited the air circulation around the engine cylinder to the point of being almost non-existent. The cowling was hollowed completely, and then covered inside to form an air tunnel past the cylinder, without blowing exhaust into the tank compartment.

Subsequent flights have shown that the Denight Special handles easily (but quickly), being highly maneuverable. Ours is not an exceptionally fast ship as Goodyear racers go, but perhaps this is good, especially for a newcomer to pylon.

If you like exciting flying, give N.M.P.R.A. pylon racing a try — it's great!

Our tired old Andrews' H Ray is still logging in flights, now over 400, and until last week had not suffered a scratch — then, high over the field, the Radio Fairy stuck his finger into our Minipulse jamming the controls in neutral rudder and high throttle (up elevator effect as the ship is trimmed). The ship started a seemingly endless series of loops. Lower, lower—until finally that all too well known sound of balsa meeting terra firma — straight in! The nose buried itself a good four inches into the earth, hiding like an ostrich, with its tail pointing straight at the sky. Total

damage — one very dirty engine!! Need we say more?

Incidentally, we have been advised that the Minipulse servo that we have been using will not be produced at this time, due to some parts procurement problems.

The Meinke pre-fab Royal Coachman kit described last month has been completed. Only a couple of evenings were required, to be completely doped and ready to fly. A single channel Kraft receiver was used (for want of more elaborate gear), giving propo rudder and a pulse omission detector (POD) for throttle. The ship flies exceptionally well as a rudder only using an Enya .09TV for power. In the near future, we hope to latch on to a six channel reed rig and add elevators to the Coachman,

Son Don — says he's going to learn to fly this one. Watch out, Weirick!

and increase the power to a .19. The Royal Coachman "Kit" is excellent in all respects. (The design is a little square, but then so is the designer.)

Bob Williams has come up with our hint for the month. Try covering your next fuselage with a pair of textured nylons! Simply slip one on from each end — only one joint, right through the wing area where the added strength can be used. By color doping the fuselage first, and using only clear dope over the stockings, many unusual effects can be achieved. Bob has a Sr. Falcon painted flesh color, covered with black nylons. It's the sexiest ship on the field anyway. Give it a try! Are your seams straight fella?

Personally, we'd rather see them on legs!

See **you** at the field!

The Royal Coachman glides in —



NEW

PYLON RACING ACCESSORIES

for the Miniature Goodyear Event
of HIGH IMPACT, PAINTABLE, MATERIAL



Nylon

WING MOUNTING KIT

Four Piece WING MOUNTING KIT .99c



RACING SPINNERS

2½" Diam. \$ 1.59 2¾" Diam. \$ 1.79



Two Piece, Held with Prop-Nut and Washer

Moulded WHEEL PANTS

Set of Right and Left \$ 3.10 Length 9¾"



Moulded CHEEK COWLS

Set of Right and Left \$ 1.98 Length 8¾"



RACING PILOT

2½" SCALE PILOT \$1.10



RACING WHEELS

SMOOTH CONTOUR 2¾" Diam.

SC-2 \$ 2.25



BUBBLE CANOPY .98c 10"

Coming Soon "La Jollita" Goodyear Racer

HEADREST CANOPY .79c

TOP OUT

(Continued from Page 44)

been tough but worthwhile, since they've collected over 60 trophies since the 'team' concept was started! The value of this experience showed up at

Dick Dixon, Austin (Texas) Aqua Festival Class I Novice winner and his version of deBolt's Jenny. McCoy 35 and Controlaire Reeds with transmitters makes a serviceable contest arrangement good for hundreds of flying hours.

the Nats since Miles' highest total point win is one that requires consistent performance along with pattern flying know-how. As a progressive move, Miles has suggested that contest scoring include points for "general presentation" which would reflect the full-size aircraft flight characteristics the flier is able to

achieve. An interesting thought. . .

Hank Walker and Sims Alexander of the Austin (Tex.) RC Association hosted the 2nd Annual Aqua Festival RC contest on August 14 & 15. Major Walker, an Air Force pilot, is club president, and together with Sims, as well as with the help of Vic Mathias, honorary Admiral of the Aqua Festival, ably sustained the Association's desire to build the reputation of their annual effort. Spectator attendance was good and interest was sustained by effective commentary and description of the flying activity. Part of the success in keeping this interest came about by acquainting onlookers with the fliers and their planes via a good PA system. Standings, scores, and other pertinent poop not only kept the crowd informed but livened competition! The fact that Dick Dixon (why do I spell it - Dickson?) class I novice winner, outscored the experts added spice to the watching as well as sparking action between the two groups. And so it was that Buddy Brammer and yours truly in taking 2nd and 1st place expert hardware pledged future vengeance on Dick for his single point edge.

Baton Rouge during Fundora Time was the scene of further class I warfare where the 5th annual "Cajun Classic" contest took place in the country club-like atmosphere of the new BRRC Club flying field. Welcome was made to all



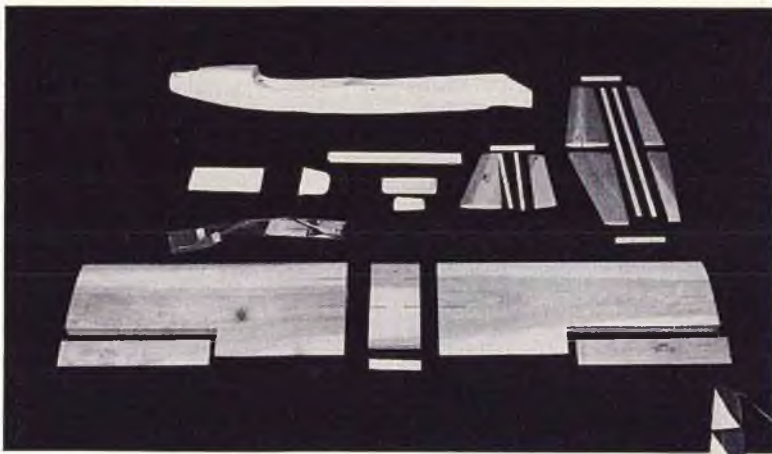

CHECK THESE QUALITY FEATURES

- ✓ FUSELAGE—Made of high impact plastic. NOT FIBERGLAS.
- ✓ Fully assembled.
- ✓ Completely fuel proof.
- ✓ Room for any multi-channel equipment made.
- ✓ Exceptionally rugged.
- ✓ WING, STAB, AND RUDDER made of foam for trueness and FULLY covered.
- ✓ Pre-fitted at factory.
- ✓ Unique nylon wing and stab hold downs.
- ✓ No rubberbands necessary.
- ✓ All necessary hardware.
- ✓ Pre-bent landing gear.
- ✓ Fully flight tested.

a new husky one

The Early Bird

The Complete Pre-fabricated Kit for Professional as well as Novice.

THIS IS A FULL SIZED, MULTI-CHANNEL AIRPLANE EXCELLENT AS A MULTI-TRAINER

**SAVES MONEY AND TIME
SATISFACTION GUARANTEED
OR YOUR MONEY BACK**



**ONLY
\$44.95**

Wing Span 60" Wing Area 700 Sq. In. Length 46 3/4"
Weight with F & M Proportional and K & B 45 — 6 1/4 lbs.

Woodcraft

7521 Menaul, N.E. • Albuquerque, New Mexico

by the genial club prexy, Sid Voight and the obliging Mike Kleinpeter, who CD'd the meet. Ideal, cool weather blessed the affair, which saw flying suitable to the occasion and the 'crowning' of George Sexton as "King of the Cajuns" as top Baton Rouge scorer. Joe Myles of Pascagoula (hm) La. battled closely in class III with Norm Rhodes and finally edged him in the two day match. Joe's national reputation continues to grow as his propo skill increases—he should be a real contender in Chicago, come 1966.

Buddy Brammer had a new class I ship, a modified Genie, with which to try to even the score with Dick Dixon who was now flying his well-worn Jenny in expert. It was close all the way and

Dick didn't let up, but when the score was tallied, Buddy was 5 points ahead for the tallest trophy. Coupled with the calm wind, class I performance by the six rudder fliers was a revelation to many of the Louisiana fliers who had just about given up the class for contest participation. Encouraged by increased activity earlier at the Alexandria contest it was included, proved a prime attraction and RC motivator at the 1965 "Cajun Classic."

in-the-season flying. Norm Rhodes came back to RO with his Enya 45 powered Texas Mambo to take top honors. Norm is a 'all RC' flier who performs ably and garners hardware in all five RC events. (It's wondered how many others there are who can show wins in all AMA events during 1965?) A Port Arthur Texas school teacher, Norm has been RCing four years, devotes his spare time to flying and helping others. Well thought of along contest trails, he's a graceful winner and, if need be, a sportin' loser who often helps opponents into the air to score against him.

Next month: details of the Oklahoma City American RC Annual Contest.

FAI

Response to the proposal to consider class I for FAI competition has been gratifying. Club as well as individuals have expressed unanimous endorsement of the idea of having a team selected for international action. At this point it is important to recognize that a lot of groundwork and effort must take place before class I ships will see FAI competition. Sustained and continued encouragement of AMA, especially the Executive Council, in their spadework will be necessary to assure them that grass roots support is real since the chore of ironing out the many problems through international action are consid-



Mike Kleinpeter and Sid Voight line things up as they prepare for the Annual Baton Rouge R/C Club "Cajun Classic."



George Sexton gathers in his 'crown' as "King of the Cajuns" after beating competitors at Baton Rouge.

August flying was closed out at the 7th Lake Jackson (Tex.) meet where a field of seven class I fliers and three class III'ers showed the top form of late-



- The lowest priced interference-free single channel system on the market today.
- Provides selective rudder plus up-elevator from a single escapement.
- Designed for the smaller models, but adequate up to .15 size.
- Complete system includes transmitter, receiver, escapement, battery clip and switch panel.

- ✓ Maximum ground range for "out-of-sight" air range
- ✓ Standard 9-volt transistor radio batteries used throughout
- ✓ A new concept in superregenerative receivers — interference immunity from Citizens Band operation due to the extremely high selective audio frequency of 6000 cycles
- ✓ No FCC license required . . . you save \$8
- ✓ Extremely light and compact — ideal for small-field sport flying —
- ✓ TESTED AS A SYSTEM AT THE FACTORY BEFORE SHIPMENT TO YOU!

SPORT FLYERS SPECIAL!

LIMITED TIME ONLY

BABCOCK BC-21 SYSTEM

PLUS

FREE COX .020 ENGINE

AND FULL SIZE

D.Q.A. 704 PLANS

\$39.⁹⁵

ACT NOW! Offer Is Limited!

Send cash, check or money order.
California residents add 4% tax.

BABCOCK CONTROLS INC.

P. O. Box 666 Laguna Beach, Calif. 92652

erable. This, of course is understandable, as no one wants to take on a tough task of little purpose. As long as sufficient interest and support is generated it will make sense to undertake the exploratory study and negotiations necessary to at least see what's required to make rudder an FAI reality.

MISCELLANY

● A special tip of the flight cap to L. V. Johnston of Dallas who gave valuable service in Philadelphia as a flight line coordinator and continued the pioneering development of that gentlemanly art. By nurturing talent in this officiating necessity, 'LV' is helping to create a contest operations group gaining broad respect and having national recognition. . . .

● . . . saw results of the 1965 Internats and noticed the Russian fliers did not compete. Wonder why? Also noted Weirick's fabulous 7269 point third flight!

● Expect that the possibility of five new RC channels in the 72 to 76 MC spectrum will bring on mixed feelings. Although the usual 27 MC spots may still be available indefinitely, many will itch to leap to the new frequencies. Others will ponder how this will affect equipment plans and operation of the 1966 Nats. . . .

● Like many I'm a habit user of props. Recently I had to borrow a dif-

ferent brand and thus got acquainted with GM nylon props. Used a 10-6 on the old VECO 35 and noticed a lot better pull in flight. Looked close and found other contest fliers are using them too. Taxi power is improved and acceleration is faster, more direct acting. They're less expensive, too. . . .

● A good friend (you'll see how good in a moment), Gerald Schoenert of San Antonio, loaned me his collection of 1929 to 1933 Model Airplane News magazines! Going through them is an experience every red blooded modeler ought to be able to do. In some ways it's a ball, in many others there's much to respect in those old yellowed pages. It seemed many important aviation celebrities were reflected as encouraging modeling in those days. Haven't seen that lately. Also, and surprisingly so, kit prices were high considering quality and purchasing power usually alleged for the period.

In the January 1932 issue a picture of Frank Zaic was found as he proudly posed with his Stern Bros. Department Store trophy. This piece of history struck a chordant note and we dug out a recent letter from Frank and found this quote: "We should make an effort to record the present so that future builders will have something to laugh about when they see our models and designing efforts." Although the old pic noted Frank had won a speed

event at 62 mph it didn't say how or with what. How 'bout it, Bub? Incidentally, Frank's letter included a contents list for his 1964 - 1965 Year Book which reflected many items of interest to RCers. Here're a few titles: RC Double Delta, Variable Wings, Soaring RC Models, Flying Wings, and nine established RC designs. Frank is not stopping at the present book, is looking for material contribution for the 1966 edition. Since the work is important to modeling check with him now at Box 135, Northridge, California on new material or orders for the 1964 - 65 book.

FOR THE GIRLS (Via Sharks Sparks and Martha Beason)

. . . found an interesting book in the library entitled, "How To Keep Your Husband Alive" (No, it's not written by a modeler — I checked!) The writer lists about 10 major ways to accomplish this, including proper diet, etc. — but devotes a major part of her book to the importance of men having a hobby! Seems they're better adjusted, more successful in their chosen occupations and live longer than men who do nothing creative in their spare time. . . .

Do you wish he looked neater on the flying field? Try buying him some of the new "perma-pressed" pants and wash and wear nylon tricort shirts to use while flying — they clean up easily with

NEW—From ACE R/C

NEW! ELECTRIC BRAKES FOR YOUR R/C MODELS!

NOW An electric brake for your R/C models, developed by Dr. Walter A. Good. In the testing stage for over a year, this lightweight unit provides up to 8 inch ounces torque drag on 2.4 volts, with a drain of only 160 mils. May be used with 2 to 6 volts. Coil resistance is 15 ohms. Now get electric braking for your R/C model in this Ace exclusive, by special arrangement with Walt Good.

Braking action is by magnetism—employs no shoes. Use of special formula alloy, cuts residual magnetism to almost nothing.

Will fit most R/C wheels. Designed for a 5/32" axle.

Packaged with one brake and complete instructions per package.

No. 25A55—Ace-WAG Electric Brake . . . \$6.95

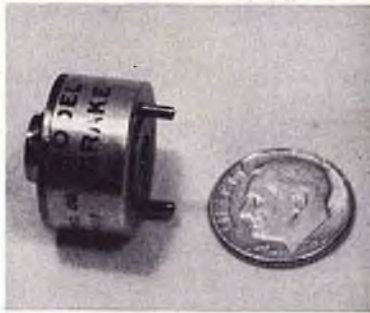

ACE RADIO CONTROL • BOX 101 • HIGGINSVILLE, MISSOURI 64037

BILL NORTHROP SETS ALTITUDE WORLD RECORD OF 16,690 FEET

USES 3½ YEAR OLD
QUADRUPLEX MK II



- Straight line distance from transmitter was: 19,020 feet, or over 3½ miles!
- Radio gear was same as used in Gipsy Moth to place third in Scale at the 1965 Nationals, and for everyday flying. No special gimmicks.
- Maximum distance check with transmitter: antenna removed, moments before record flight, was the usual 30 to 35 feet.

Bill says,

"The old gray box, she's still what she's always been . . . RELIABLE."

This same reliability has been the outstanding feature of all Dee Bee equipment, from the "old gray box" right up to the present "CL 5" feedback system.

Write for descriptive brochure.

PROPORTIONAL DEE BEE ENGINEERING CO.
West Lambs Road
Pitman
New Jersey
QUADRUPLEX

an overnight soak in Wisk to take out the fuel stains. . . .

Someone suggested a way to seem busy when they come home is to have all your appliances running (no matter if the washer's empty—it makes lotsa noise!) and have the table all set for dinner. So what if the chicken's still frozen—sit there and talk about airplanes until it's ready to cook—he may even invite you out to dinner if you're lucky!

Contest Techniques

Before going on with more details on class I flight technique, here are some considerations to keep in mind before pushin' the switches. This guide is aimed at being applied to the maximum number of flight situations, however in many instances it'll take interpolation or adjustment in some maneuvers or their phases to fit your own particular set of conditions or ship arrangement. Planes vary a good deal in wing loading, aerodynamics, power loading, engine thrust line, gross weight, etc, etc—and therefore alter what may be needed in timing and flying methods. In addition, flying field size or facilities (grass or runways, for example) are other varying factors that combine with weather and altitude variances to make our chore individual, mighty interestin', and a challenge. What's in this feature is intended as 'middle ground'—a sort of reference point from which your own efforts may start or be compared with. Remember, as we said in the beginning—it'll take practice. That still goes. . . .

TOUCH AND GO

In spite of the talk of how easy some find this little jewel, it's still the 'guts' maneuver at any contest for all classes. Purposely placed at the beginning part of the pattern, many bypass it due to the risk of losing points on all the remaining maneuvers for the sake of 2 or 4 points. Although this may seem reasonable it doesn't account for the points that may accrue to those that try over those who won't since judges generally favor the "triers." In other words, if it's found that if more than 25% of the touch and goes are being skipped over a period of several contests better look again at the scores—it may be well worth some practice and some risk. In any case, here's one way of going about doing the Touch and Go. . . .

As the Overhead Eight is finished, the aircraft will be moving downwind at a fair clip. This momentum is useful in making the first turn which is started at the overhead or transmitter position as soon as possible to avoid extending turns too far down wind. What'll be done is called a 180° overhead approach which consists of a 45°

turn (right or left, but away from the spectators), a straight flight for 75 to 200 feet, an opposite turn to put the plane on its base leg 90° to the wind, then a 90° turn into the approach followed by touchdown, and finally, the take-off. Let's take a close look at each segment separately. . . .

The 45° turn is started as you call "Touch an' Go! to the judges and it is completed fairly rapidly. This is followed by a power adjustment to maintain level flight on the 45° leg. Incidentally, if the wind is high the 45° turn should be more like 60° to compensate or 'crab' for drift. The objective of the turn is to gain position for a good base leg — a track over the ground 90° from the direction of landing. A proper base leg is one not too close or too far away from the intended touch-down point and will allow a power off (or almost off) glide to the landing. Consistency in establishing a base leg — that is, its height and distance — is a prime key in making good landings a high percentage of the time. So try to put the ship in the same place on each landing pattern whether it's the Touch and Go or the final approach the end of the pattern.

As the intended base leg is almost reached, add a tap of power and start a medium banked turn of at least 135°, turning toward the approach line. Take care to maintain altitude and level the wings on a heading where the ship will make good a track 90° to the approach. A correct crab angle will assure this, so take close note on first attempts. Now the decisive moment is coming! At a point on the base leg where you think the ship can glide through the remaining maneuvers to touch-down — that is, to the approach leg, make the final turn, and then reach the intended landing spot — ease the power off and let's see what happens. The first thing to check is that crab angle — with power off slower speed will tend to drift the ship away — so gently pull the nose toward you a few degrees. About now that final turn will be due so be sharp, this may be critical. Quickly decide whether the plane can glide through the turn — it'll use quite a bit of altitude going through it — so add some power if you think you're low, leave it off if high. Try to make the turn constant and of a medium rate, and gauge it so that the rollout is on the proper approach line. Rolling out on the line is a lot easier said than done, even in mild wind, but try anyway. If the base leg was established at the correct altitude and distance for your ship and the wind conditions, the approach glide will be long enough so that any dipping oscillations will smooth out and the descent may be at a constant angle. Again depending upon the

(Continued on Page 62)

PROPORTIONAL HEADQUARTERS!

(Export Wholesale only)

Babcock
Bonner Digimite
C&S Digicon II.
Citizen-Ship Analog
Controlaire
Dee Bee Quadrplex CL-5 & 21

E.K. Logictrol
F&M Digital-5
Kraft Custom KP-4
Micro Avionics
Orbit Quad Analog & 3+1
R/C Modeler Digitrio

And more coming!

EXPORTATIONS

(Now ready to serve you even better
in our new larger quarters)

2137 N. Marianna Ave.

Los Angeles, Calif. 90032

Tel. (213) 221-6968, Cable: Extrinsic

PLACE YOUR ORDER NOW—MULTI-TRAINER

Fiberglass Sr. Falcon

Complete
Kit

\$29⁹⁵



Fiberglass fuse more rounded than original Sr. Falcon Kit. Contains authentic Sr. Falcon plans, die-cut wood parts and hardware by Carl Goldberg Models. Features semi-symmetrical wing; motor bearers molded in for 6 to 10 channels or proportioned, and .35 - .45 engines. Complete kit, \$29.95. Fuselage only, \$19.95.



\$19⁹⁵

ADVANCE ORDERS BEING TAKEN NOW! FIBERGLAS AEOLUS
GOODYEAR PYLON RACER

Contains fiberglass fuselage; cheek cowls and wheel pants, of high impact plastic. Fuselage only, \$28.50 plus postage.

Dealer Inquiries Invited!



ACTION INDUSTRIES, INC.

4125 Reisterstown Rd.
Baltimore, Md. 21215

ACTION INDUSTRIES, INC. R.C.M. 6
4125 REISTERSTOWN RD.
BALTIMORE, MD. 21215

- Fiberglass Sr. Falcon Kit (\$29.95)
- Fiberglass Sr. Falcon Fuselage (\$19.95)
- Fiberglass Aeolus Fuselage (\$24.95)

Plus postage

(NOTE: SEND CASH, CHECK OR MONEY ORDER)
SORRY NO C.O.D.'s

NAME.....

ADDRESS.....

CITY & STATE.....

(Maryland Residents Add 3% Sales Tax)

YOU CAN HELP... A personal appeal from Don Dewey

This is not an advertisement in the true sense of the word, but rather, an appeal from Radio Control Modeler Magazine to YOU . . . for YOUR HELP.

This month's Editor's Memo carries the story of the Academy of Model Aeronautics and their urgent need for your membership — your needed support in order to continue to promote the widespread activities of model aviation in this country as they have for the past thirty years. With the phenomenal growth of radio control activities, it is imperative that every RC'er support the Academy by his individual membership. As the editor of Radio Control Modeler Magazine, and as a Leader Member of the A.M.A., I appeal to you to send your membership to the Academy TODAY! Only in this fashion can we continue to enjoy the many benefits offered in model aviation — by unanimously supporting the organization of individual modelers who, as a collective body, work for the common welfare of all modelers.

YOU CAN ALSO HELP by supporting the F.A.I. Internat's R/C Team Transportation Fund. This year, the greatest model aircraft flying demonstration in history will be a feature attraction of the International AeroClassic to be held at the Palm Springs Airport, November 11-14. During this full-scale air show, several of the nation's top R/C flyers will be on call at the show from

9:00 A.M. to 6:00 P.M. for five days, during which time they will put on demonstration pylon racing plus free-style R/C aerobatics — all donated time without any form of compensation for the individual flyers.

In return for the radio control demonstrations, the AeroClassic will contribute \$1000 to the A.M.A.-F.A.I. Internat's R/C Team Transportation Fund in order to help defray the costs of sending the next R/C Internat's team overseas to compete for the United States. This money will be made available for this purpose *only* if RC'ers throughout the country — YOU AND I — match this amount with an additional \$1000 made up of individual contributions.

YOU CAN HELP — by sending in your A.M.A. membership *today*, if you are not already a member. In this fashion, you will be supporting the governing body for model aviation in the United States . . . guaranteeing that radio control will be well represented in the years to come.

YOU CAN HELP — by sending in your individual contribution, in any amount, to aid in sending the next R/C Internat's team overseas to compete for individual and U.S. team honors. A list of contributors will be published periodically in Radio Control Modeler Magazine along with a running tally of the total amount received to date.

YOU CAN HELP.

MEMBERSHIP/LICENSE APPLICATION

Name Please Print Plainly

Street Address

City & State

Zip New AMA No. will be assigned unless proof of last year's no. is enclosed (license card, mail label)

All licenses expire on December 31, of current year.

Check below to indicate item(s) for which remittance is enclosed.

JUNIOR (up to but not incl. 16 years old*) \$3.00

SENIOR (16 through 20 years old*) 4.50

OPEN (21 years or older*) LEADER MEMBER RENEWAL 6.00

FAI STAMP \$1.00

Extra POSTAGE if faster return service is desired:
air mail—25¢; special delivery—30¢; air mail special delivery—55¢

* Your license classification is based on your age as of July 1 each year.

FAI STAMP—Only required on AMA License Card to compete in FAI team selection programs. Not required to fly in FAI events at AMA contests. \$1.25 if purchased separately from license application.

LEADER MEMBERSHIP application forms are available—to Open AMA members only—who may qualify as contest directors and/or administrative, scientific or industrial leaders. Only extra charge for this category of membership is handling fee for transfer of membership category (explained on form).

FAMILY RATE—For each Jr. and/or Sr. license application accompanying one Open application, deduct \$1.00. For each Jr. and/or Sr. license application accompanying two Open applications, deduct \$2.00. All applications must be submitted together, must be in same last name, with same address. Only one Model Aviation subscription will go to a family. If extra forms are needed, request same from AMA Headquarters.

1239 VERMONT AVENUE, N.W. WASHINGTON, D.C. 20005
ACADEMY OF MODEL AERONAUTICS

ACADEMY OF MODEL AERONAUTICS

F.A.I. Internat's
R/C Team Transportation Fund,
1239 Vermont Avenue, N.W.
Washington, D. C. 20005

I am contributing the sum of \$_____ by
check ___ cash ___ money order ___ to help support the F.A.I. Internat's R/C Team Transportation Fund. Please record my contribution in the name of:

Name Age

Address

City State

A Christmas Gift Subscription to
R/C Modeler Magazine is a Gift
That Will Be Remembered Every
Month of the Coming Year.



Holiday Greetings

... a Christmas Gift Subscription to

RADIO CONTROL MODELER MAGAZINE

At Special Christmas Rates

is One He'll Thank You For Every Month
Of The Year

THE WORLD'S LARGEST LEADING MODEL
PUBLICATION FOR THE ACTIVE RC'ER

RADIO CONTROL Magazine

MODELER P. O. Box 487 • Sierra Madre, California

\$4.75 One Year

\$8.50 Two Years

\$_____ enclosed. Send Christmas Gift Subscriptions
to the following persons:

NAME _____
ADDRESS _____
CITY _____ STATE _____ ZIP _____

NAME _____
ADDRESS _____
CITY _____ STATE _____ ZIP _____

Please send gift cards in the name of: _____

Expires Dec. 30, 1965

TOP OUT

(Continued from Page 59)

characteristics of your plane, but probably between 7 to 20 feet, momentarily feed in the power to about half throttle in order to rotate the nose to a landing position. Ideally, the ship will round out at 6 to 12 inches and settle in a second or so after the throttle is chopped. Don't stop now even though it was a picture landing — you've got the 'Go' to go!

Maintaining directional control will be best accomplished if you've positioned the landing and yourself so that the take-off line is close. After making sure the ship's 'un-airborne,' add throttle to about three-fourths power and let her rotate through a lift-off as described in the July RCM for a regular take-off. Remember though, don't over power in the excitement and let the ship zoom — try for the 'pause' as originally described and make the climbout sooth and gentle. One last word — although you may not always intend to make the Touch and Go maneuver, put the 180° overhead approach pattern in the flight. Besides the practice, doing so will maintain your timing and aircraft positioning which must be developed as constant as the multitude of variables will allow.

Next month — the 'easy ones' — the Wingover and Barrel Roll.

SUNDAY FLIER

(Continued from Page 45)

enough to bring the nose into a normal glide angle), and the model will settle to the ground into the wind, for a soft landing.

It reads easy, and it is after a few practice flights! However, there still will be those times when the engine sags, or quits, just at an awkward point. This is when the tight turn technique becomes very useful.

Don't misunderstand me on one point. Tight flipper turns can be made in either direction. It's easier, with escapements, to the left, since up elevator follows left rudder. But if you need to make one to the right, the single pulse for right rudder, followed by two quick pulses and hold (to go through left rudder and stop on the up elevator position) will give you an equally effective tight turn to the right. Practice them both, and you'll soon be amazed at the small area in which you can safely fly.

So much for small field flying techniques with escapements. But this brings a question to my mind. I've been using escapements for years, and still do. Servos are coming in fast and furious, but it seems to me that there are



NELSON MODEL PRODUCTS INC.
SPECIALIZING IN RADIO CONTROL PRODUCTS

PLANS SERVICE

PR1 BONZO — \$3.50	PR5 SHOESTRING — \$3.00	PR2 LI'L KNARF — \$3.00
PR3 LOVING SPECIAL — \$3.00	PR6 LITTLE TONI — \$3.00	PR7 MISS TAKE — \$3.00
PR4 RIVETS — \$3.00	PR8 ZIPPER — \$3.00	PR9 BONZO — \$3.00

CONTEST & SPORT
MT1 PRIMER — \$3.50
(All plans 5 oz.)

#MS 1 5 oz. Fully Detailed
All Goodyear Plans Conform to N.M.P.R.A. Rules
DEALER INQUIRIES INVITED. STANDARD DEALER DISCOUNTS.
MINIMUM ORDER 3 SETS. WRITE FOR COMPLETE PLANS LIST.
Nelson Model Products Inc.

Send check or M.O. only. For special handling add 5c per ounce for 1st class mail, 8c per ounce for air mail. All plans 4 ounces except PR1 which is 5 ounces. Add 15% for foreign orders. California residents add 4% sales tax.

1418 W. Winton Avenue
Hayward, California

QUALITY R/C ACCESSORIES by DU-BRO

Du-Bro LINKAGE ARM
(FOR BONNER SERVOS)
Ideal set-up for nose wheel and rudder or engine control where less throw is needed. .050 steel.
only 49c
Stock No. LA-3

Du-Bro DUAL TAKE-OFF
FOR BONNER SERVOS
only 49c
With a Du-Bro DURA-V-LINK it makes an ideal hook-up for dual or single take-offs. take-off from either end of servo. Brass.
Stock No. DT-4

Du-Bro DURA-CONNECTOR & V-LINK
For proportional sets using disc servos.
Stock No. DCL-2
only 98c

Du-Bro DURA-V-LINK
CLOSE-UP OF CLEVIS
only 49c
For use with Du-Bro DURA-CONNECTORS and Du-Bro DUAL TAKE-OFFS. Also ideal for other servos with eyelet style take-offs. Spring steel. Stock No. DVL-1

Du-Bro DURA-COLLARS
Best collars available. Pugged cadmium plated brass. Threads will not strip. Complete with set screws and Allen wrench. Stronger than aluminum type.
4 FOR 59c

Du-Bro DURA-LINK GUARDS
For those who feel the necessity... a removable safety guard to "positive lock" all links.
4 FOR 10c
Stock No. LG-10

Du-Bro TB-2-TRIM BAR
FOR BONNER SERVOS
Can be modified to Ancco servos. Designed for inline or side by side hook-up. Lightweight.
\$1.95

The ORIGINAL Du-Bro KWIK-LINK
CONTROL YOKE ASSEMBLY
... for any control linkage!
THE TOP QUALITY LINK
Split Coupling Sleeve
3/4" thread on 4" rod
Stock No. KL-49
49c
MADE IN THE U.S.A.

Du-Bro 6 SPOKE DURA-HUB WHEELS
Permanently pneumatic stronger unbreakable
2 1/4" (1 1/4 oz.) — \$2.59
2 1/2" (2 oz.) — 2.79
2 3/4" (2 1/2 oz.) — 2.99
3" (3 oz.) — 3.19
3 1/4" (3 1/2 oz.) — 3.39
3 1/2" (4 oz.) — 3.59

Du-Bro POSITIVE ACTION WHEEL BRAKES
1/2 oz. each. Steel brake drum eliminates scoring. Spring steel control arm.
only \$7.95 pair
WHEELS NOT INCLUDED

SERVO MOUNTING HARDWARE PACK
BOLT (3 AB)
WASHER
SPACER
BLIND MOUNTING NUT
Hardware for one servo. Stock No. SM 55
Packaged 12 to card.
55c
Hardware for five servos. Stock No. SM 239
Packaged 3 to a card.
\$2.39

Du-Bro BLIND MOUNTING NUTS
Can be used on 1/8" plywood (without sticking thru) and thicker. 4 per pkg. 3 thread sizes:
2-56 Stock No. BN256
3-48 Stock No. BN348
4-40 Stock No. BN440
EACH 20c
49c

DU-BRO PRODUCTS • 7667 Milwaukee Avenue • Niles, Illinois 60648

still thousands of escapement fliers. I've had a couple of discussions of this point — have single channel servos taken over? I wonder. So how about it, you Sunday fliers? Drop me a card and tell me, how many guys at your field fly single channel servos compared to escapements? I'll publish the numbers and ratio in a future column. To start the pot boiling, though, here's a guess, three escapements to every servo, or actuator of the magnetic type.

Send the card to me at this address:
Ken Willard
665 Riviera Dr.
Los Altos, California

That way our penny-pinching (he has to be!) Managing Editor won't have to put a stamp on your cards for forwarding. Also, I'll get them quicker.

And if you want a reply of any sort, send a self addressed card or envelope, with stamp (I have to pinch pennies too) and I'll do my best to answer your queries.

Here's a couple of interesting items. Ollie Bakken, one of my co-workers at Lockheed, put six channels, and an Enya .09 in a Schoolmaster. Photos show a neat servo setup, and a happy flier. Multi-equipment is getting more and more adaptable to small airplanes.

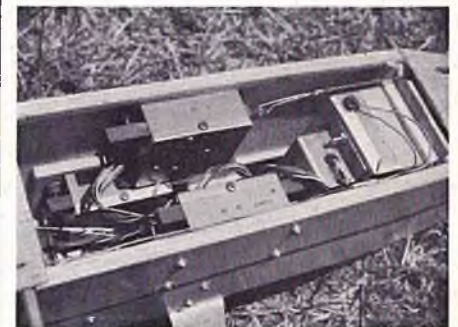

Just got a sample Schoolgirl kit from Top Flite. Very nice. I'll let somebody else review it, but I gotta hand it to Mike and Sid. Now I may be prejudiced, but I think the Schoolgirl is a real cute biplane, or high wing monoplane if you prefer. I've flown it both ways, and with .020 and .049 power. It's real zippy, spicy, in fact. And Top Flite agrees with me. Right on the label. It says so — "No spicing required!" 'Nuf said.

HEADQUARTERS FOR RADIO CONTROL GLIDERS



KURWI 33 R/C SAILPLANE—FIBERGLASS FUSELAGE—108"	\$ 40.00
ZUGVOGEL III R/C SCALE GLIDER KIT 94½"	\$25.00
WIK STANDARD AUSTRIA R/C SCALE KIT 88"	\$24.00
Lo-100 AEROBATIC R/C GLIDER KIT 80"	\$23.00
BJORN "BS-1" SCALE SAILPLANE KIT 86"	\$22.00
SB-7 R/C SCALE GLIDER KIT BY SCHUCO 90"	\$21.00
SCHLEICHER K-10 R/C SCALE GLIDER 79"	\$20.00
BERGFALKE II/55 SCALE GLIDER KIT 90"	\$18.00
SCHLEICHER K-8b R/C SAILPLANE KIT 71"	\$16.00
WEIHE 50 SCALE GLIDER KIT FOR R/C 71"	\$15.00
RHONADLER Ka-7 SCALE GLIDER KIT 74¼"	\$15.00
BARON—POWERED SAILPLANE KIT—USES .15 R/C ENGINE—104"	30.00
GRAUPNER CLOU R/C GLIDER KIT—74.5" & 96.5" WINGS—	30.00
WIK MISTRAL—GRACEFUL SAILPLANE KIT WITH 10' WING—	31.00

WILLOUGHBY ENTERPRISES

14695 CANDEDA PLACE,

(714) 544-2077

TUSTIN, CALIF. 92680

THE SHOWOFF

(Continued from Page 30)



on the top leading and trailing edge sheets, let dry, then very carefully put these sheets in place. Cut out the cap strips to fit, brush on contact cement, and when dry, put these in place. Now allow the wing panels to dry overnight. If you used a large building board, you were able to build all four wing panels at one time.

When all is dry, remove the panels from the board and glue in the dihedral brace, blocking up the two halves of each wing the amount shown on the plans. When this has dried thoroughly, return to the contact cement can and install the bottom leading edge sheets. Glue the tip blocks in place and carve to shape. Now sand the wings lightly, remembering that it is then wood, then cut out the ailerons where shown on the bottom wing. Add the ¼" plywood reinforcement for the aileron horns. Sheet the front of the aileron servo in the lower wing. Be sure to cut the holes for the aileron push rods. Now take a piece of very strong cloth, cover it with white glue, and wrap around the center section of the wing. Use pinking tape, if you have it around the shop. When all of this is dry, we can sand with fine paper, apply two coats of dope, and set aside for covering later on.

Empennage. The stabilizer is made much the same manner as the wing, using contact cement whenever possible. Build the framework of balsa and white glue and then contact cement the top sheets in place. Remove from the plans and contact the bottom sheets to the frame. Install the tip block, carve, sand, and set aside for covering.

The rudder is constructed from ¼" sheet and presents no problems.

Fuselage. A few different construction ideas are used in the Showoff fuselage. Almost all "box-type" bodies turn out to have an alignment problem by the time they are finished. This can be eliminated in a variety of ways, but I use one that has proven to be both fast and easy. For lack of a more glamorous name, we'll call it simply "crutch construction." Pin down, on the top view

For the Utmost in Advanced . . .
ENGINEERING, QUALITY, AND RELIABILITY
...DEPEND ON KRAFT



All Kraft transmitters are exceptionally powerful, drift free, and operate from inexpensive, long-life, dry batteries. The 6, 10, and 12 channel transmitters are dual simultaneous. All Kraft receivers use the same basic superheterodyne circuit whether single channel or proportional. The reed receivers are the smallest and lightest available.

Kraft Matched Sets — Transmitter with Superhet Receiver

1 Channel	6 Channel	10 Channel	12 Channel
\$64.95	\$119.95	\$189.95	\$209.95

Kraft Proportional System
 (now in production)
 complete system with all
 accessories, ready to install

\$489.95

Kraft Heavy Duty
 600 Mah Reed Battery Pack
 \$19.95

With matching charger
 \$23.90

Kraft Systems, Inc.

2519 Lee Avenue • South El Monte, Calif.

All Kraft Custom Radio Control products are available through your local Kraft Franchised Dealer. If unavailable, you may order direct from the factory. Be sure to include check or money order for items ordered. If you prefer, you may send a 50% deposit, balance C.O.D. Calif. residents add 4% sales tax.

NORTHERN CALIF. R/C MODELERS

\$ SAVE MONEY \$

ON YOUR NEW UP-TO-DATE R/C EQUIPMENT

Trade in your old R/C gear or engine, get the newest, the latest R/C system

**Buy the Correct
Choice the First Time**

Send 25c for Latest List of New
and Used R/C Equipment

Since 1946

ROOT'S HOBBY HUT

6036 TELEGRAPH AVE. OAKLAND, CALIF.
NOON TO 5 P.M. EVENINGS 7-9

**BUY IT WHERE
YOU CAN SEE IT OPERATE**

CANADA

WESTERN CANADA'S FASTEST
GROWING MAIL ORDER HOUSE

CALGARY HOBBY SUPPLY

1225 11TH AVE. S.W.
CALGARY, ALBERTA

R.C. SPECIALISTS
AUTHORIZED KRAFT DEALER

Everything for the Aeromodeler

Full line of all major mfgs. Most deliveries
from stock. Complete stock Sig Balsa wood.
Check our prices first.

Send 25c for catalog

**All R/C Top-Name
kits, components, accessories**
SOLD • TRADED

Only ALLIED HOBBIES gives you full trade-in value on R/C equipment no matter what your purchase. Take advantage of present low sale prices without taking a total loss on what you have. **YOUR PRESENT EQUIPMENT MAY EASILY COVER THE ENTIRE COST OF A NEW ITEM.** Send stamped, addressed envelope for special trade-in forms.

ALLIED HOBBIES
6607 RISING SUN AVE.
Philadelphia, Pa. 19111

**MOVING? Notify RCM six weeks before
you change your address.**

of the plans, a crutch of hard $\frac{1}{4}$ " x $\frac{1}{2}$ " balsa. You'll have to splice them to get enough length, so put these splices at the nose. Cut the cross pieces to fit and glue in place. At the same time, cut cross pieces for the bottom, making sure their length is correct, as shown on the plans.

While the crutch is drying, saw out the firewall from $\frac{1}{4}$ " aircraft plywood. Mark the center and thrust lines on it and drill the holes for attaching the radial engine mount. Use either the mount shown on the plans or a standard Tatone mount. Next, cut the fuselage sides to shape from either $\frac{1}{8}$ " or $\frac{3}{32}$ " balsa. Frankly, I prefer the $\frac{1}{8}$ " sheet. Cut the $\frac{1}{4}$ " balsa and $\frac{1}{16}$ " ply doublers to size. The latter can be of $\frac{3}{32}$ " ply, if you desire, but again, the $\frac{1}{16}$ " material is stronger and not too much heavier. Which ever you use, either will be much stronger than the usual balsa doublers — as can be proved by a hard landing!

Now, lay the fuselage sides down on the table, making sure you have one right and one left, open the can of contact cement, and glue in the doublers. Make sure that the plywood doubler does not extend into the $\frac{1}{2}$ " space reserved for the crutch. Cut out $\frac{1}{4}$ " square pieces for the lower tail braces and glue in place with white glue. Cut out the "truss" pieces for the tail braces from $\frac{1}{8}$ " x $\frac{1}{4}$ " hard balsa and glue these in place. Remember — save space for the crutch!

When this has set up, and your nerves are steady, apply contact cement to the outside of the crutch as well as to the sides, then allow to dry. Take one side and very carefully place it against the crutch. Start at the nose and make certain that the alignment is perfect. It isn't hard to do — just don't rush it! With the nose pressed together, smooth the body to the rear. Do this with each side. If you've made a mistake at this point, get some more wood and start again because contact cement just ain't forgiving!

Reach in with a pair of long nose pliers and remove the pins holding the crutch to the table. Slide the plans and crutch to the edge so that the firewall area is just sticking over the table. Now glue the firewall in place with epoxy glue. Add all of the bottom cross pieces and sheet over the rear of the bottom. Put on the plywood landing gear mount and the $\frac{1}{16}$ " plywood nose.

Remove the Showoff from the table and add in the extra nose doublers and blocks. The top of the fuselage is formed from expanded bead polystyrene board and then covered with $\frac{1}{16}$ " balsa sheet. Glue a block of bead board to the top of the body, using white glue. Glue the rear portion solidly, but only tack glue the front part from the cockpit forward, since this will become a removable hatch.

Next, you can cut the foam block to shape with a hot wire or saw, or alternately, carve it with a knife. At any rate, shape the block at the rear to a triangular shape, using the view at Station C, and working toward the rear. Round off the forward portion to a half circle. This all sounds much more complicated than it really is, and I'll guarantee you that when you have tried it, you will find it much easier to form complicated superstructures. In addition, it's one heck of a lot stronger than the conventional built-up balsa method. You can also sand the foam just as if it were balsa, although carving it to shape is certainly much easier. Don't bother to hollow out the foam as the weight is next to nothing. Apply the covering sheet with either white glue or a contact cement designed expressly for foam. The usual contact cement that we have used on the other parts of the ship is not to be used on foam as the solvents will destroy the plastic. The 3M company makes a contact called Adhesive #34, and the Borden company makes a contact cement called Elmers Water Base Contact Cement, both for use with styrene foams. If you have one of the commercial foam contact cements, such as Core-Grip Kwik-Stik, they can be used for the laminating of doublers and sheeting as well as for the foam-to-balsa bond.

When the top hatch is completed, cut apart at the cockpit line and install the "bird cage" braces, made from $\frac{3}{8}$ " x $\frac{1}{2}$ " hardwood motor mount stock. Install all of the extra gussets where shown and be sure to use epoxy glue for this application. Smear it on liberally, as we need all of the strength that we can obtain at these points.

Now for the Great Adventure — bending the wire "bird cage." As others have said, this separates the biplane from the "wishers." Nevertheless, with a few scraped knuckles and a good solid cuss word here and there, it can be done. A small wire bending jig, sold in most hardware stores, will be an immense help in this part of the project. Wrap the wire-to-wire joints and solder securely. I found that in doing this my soldering gun just wasn't adequate, so after lightly soldering the joints, take the wire dingus you have made and heat over a gas flame, flowing on the solder. You find your own gas flame — our Fearless Leader Editor used a Bernz-O-Matic torch, I use the gas lighter in the fireplace, and if you're a brave soul, you might try your wife's stove when she isn't looking.

While you're doing all of this, you might as well make the landing gear from $\frac{5}{32}$ " and $\frac{1}{8}$ " wire and solder at the same time. You can use an aluminum sheet type of gear if you wish, but the wire will probably add more strength. I have tried both types on the Showoff

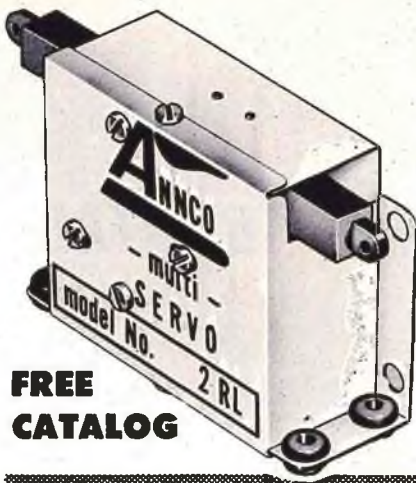

**FREE
CATALOG**

ANNCO

MULTI - SERVOS

(USE WITH REED RECEIVERS)
FOR RADIO CONTROL SYSTEMS
OF R/C PLANES - BOATS - CARS

NOW SAVE DIRECT FROM
THE MANUFACTURER . . .
Get All These Big Exclusive
Features From ANNCO

• **WEIGHT**
2R 1.3 ounces
2RL 1.7 ounces

• **THRUST** Powerful
enough for the
largest models.

• **TRAVEL**
5/8 inch straight
linear.

• **TRANSIT TIME**
1/2 second from neutral.

• **MOTOR**
5 ohm—180 ma no load.

• **BRUSHES**
97% Silver Graphite.

• **SELF-NEUTRALIZING**
or can be set up for trim.

• **AMPLIFIER**

ALL MODEL 2RL SERVOS are equipped with our 7 transistor amplifier (DK-7) that features complete burnout proof operation while adjusting centering, or if adjacent reeds are driven at the same time. DK-7 sold separately @ \$11.95 ea. postpaid.

MODEL 2R ONLY \$7.95 ppd.
(RELAY)

MODEL 2RL ONLY \$19.95 ppd.
(RELAYLESS)

**HOW TO
ORDER**

Orders will be shipped postpaid within the U.S.A. and Canada (except Air Mail—Add 25¢ each). Foreign Countries—add 50¢ each for regular mail or \$1.50 each Air Mail. **SEND YOUR ORDER TODAY!**

ANNCO ENGINEERING CO. 7714 COLFAX AVE. SO.
MINNEAPOLIS, MINN. 55423

DEALERS — Write On Your Letterhead For Special Set-Up. Only Bona Fide Hobby Dealers Accepted.

WANT TO BE AN IDLE-X-PERT?



Special additive cuts carbon and varnish build-up from top of piston. Blended for R.C. engines with closing exhaust baffle. Will help give a steadier idle and develop top power in your engine. Just add to engine intake when running. Convenient spout top!
\$.98 Each

MIDWEST PRODUCTS CO. P. O. Box 88
HOBART, INDIANA

and prefer the wire landing gear.

Now fit the bird cage in place on the body braces, drill holes for the "J" bolts, and bolt the assembly in place. Turn the body over and solder the nuts to the J bolts.

Epilogue. At this point, you are ready to apply the covering and paint your bipe. Use either silk or double cover with silkspan. The original Showoff used the double covering method — remember to cross grain the second layer to the first. Several coats of dope will make the silkspan much stronger than the silk with much less weight build-up and many less coats of dope. Cover the body and the tail surfaces in the same manner. When dry, peel off the silkspan at the elevator and on the lower wing where these two items contact the fuselage, and glue them with plenty of epoxy.

If you are not going to couple the ailerons to the rudder for control, then you can leave the lower wing removable. If you desire to utilize the fifth servo to trigger the bomb and parachute mechanism, then glue it on, couple the controls, and bomb your buddies with water bombs. The chute hatch can also serve as a bomb holder if you intend to make a maximum strike effort! I'll be the first to agree with The Dewey that this bomb and chute rig is "Mickey Mouse," but it **will** work, and the bomb drop clamp can be used to pull streamers aloft, which are released to drift on the wind while you make passes at them. It's worth the extra effort, and for those of you who have never tried coupling ailerons to rudder, you have a surprise in store! It works **well** — landing control is much more precise and you have control at slow speed where the normal aileron-only becomes mushy.

Finishing off the Showoff is up to you. I have been searching for a long time to find a finishing that would be quick and easy. This ship was finished in synthetic automobile enamel — colors, yellow and red. Old Editor in California uses spray cans of Great Western enamel — these are fuel proof, applied over Great Western gray hot rod primer, dry rapidly, and are quite good looking. Try dope or acrylic lacquer (from local auto paint stores), or HobbyPoxy if you wish.

Flying the Showoff is no different than any other multi — the wings and stab are set at zero-zero to allow it to stunt with the rest. Your real thrill will come when it breaks ground, hums into the air, and suddenly — there you are, in the cockpit, turning back the pages of time, and having a ball.

Don't forget to eject the chute over the field, drop a water or flour bomb on your best friend, do a complicated free-style aerobatic maneuver complete with colored smoke bomb, and above all — tell every one how easy it really is to build and fly a bipe.

NOW, 24 HOUR ASSEMBLY!

COMPLETE CONTROLS!
Rudder, Elevator,
Ailerons and Engine.
Wing Span: 57"
Wing Area: 620 sq. in.
Wght.: 5 lbs.

COMPLETE KIT
only \$14.95

TAKE A GOOD
LOOK AT

"JENNY"

THE NEW LIVEWIRE!

Versatile!

Use the "JENNY"
for . . .

TRAINING!
ACROBATICS!
CONTESTS!
COMBAT!

and considerable FUN!

SEND FOR COMPLETE DETAILS!

New Type Kit!

Assemble the "Jenny"
.. Like a plastic model
from completely finished parts, even the plywood fuselage! Kit has many unusual features plus all the bits and pieces required.



.19 to .45
Engines

2 or 3 wheel
landing gear!

SINGLE TO MULTI CHANNEL RADIOS!

deBOLT MODEL ENG. CO.

3833 HARLEM RD
BUFFALO 15, N. Y., U. S. A.

EDITOR'S MEMO

(Continued from Page 10)



members and they're not old enough to know the difference between an R/C model and a yo-yo. But **every** membership counts more than you know — and at least it will guarantee that this hobby and sport will still be here when they are old enough to fly if they care to do so.

There will always be an A.M.A., even if it's only for a very few. But, the road you choose **right now** will determine

whether it will be a dynamic and progressive A.M.A., **able** to represent **all** fliers, **able** to provide membership services, or **able** to be effective with the government or military branches and departments.

You, right now, can turn to the other pages in RCM and forget all about this editorial. You can go down the other fork in the road to other projects and let George do it. George will keep right on trying, because the handful of Georges have been doing it for years. For you.

Or, you can turn to the page with the A.M.A. application, fill it out, send in your check for six bucks, and know that you have done your fair share toward securing the future of this hobby for yourself, your friends, and for the future generation.

It's up to you. Right now!

In closing, this month, we are sorry to pass on the news of the death of one of our long time friends, Jerry Gause of Westee Hobby Imports and West Town Hobby Shop in Chicago, Illinois. Jerry was an ardent modeler, and born in Prague, Czechoslovakia in 1922, started building models when he was fifteen.

Coming to America in 1947, Jerry worked as a draftsman and engineer for a machine specialties company, then went into business for himself in 1960 when he took over West Town Hobby Shop. In 1962, Jerry founded Westee Hobby Imports. Somewhere among the many hours he devoted to both businesses, Jerry Gause still found time to participate in control line stunt and team racing, free flight, model rockets, and radio control. Shortly before his death he had recently completed a Veco Lil Pinto, which he had painted up as a British Spitfire, along with a Veron Viscount with Citizen-Ship Proportional.

Jerry was a personal friend of mine. He had just called to tell me that he had returned from the hospital where he had been confined for a minor heart attack. A few hours after warning me to take it easy, and not work quite so hard, word came that Jerry had passed away. Radio Control Modeler Magazine, and the entire modeling world has lost a good friend. We all share his loss, and extend our deepest sympathy to his wife Irene, and their eight year old daughter, Kim.

We'll miss you, Jerry.

PRECISION SANDER AND STRAIGHT EDGE

FOR SUPERIOR MINIATURE AIRCRAFT BUILDING



42 Inches Long

- Double surfaced sander with one side for coarse and one side for fine sanding. Complete ---\$8.95
- Extra sanding surfaces fine and coarse each .39
- Sanding surface adhesive large 5 oz tube \$1.89

- Rigid Anodized aluminum
 - Lightweight hollow section
 - Extra long 42" length prevents gouging of balsa and styrofoam
 - Especially good for smoothing styrofoam wing cores for improved adhesion
 - Trues up ribs and cap strips without breakage
 - Sanding surface holds straight edge in place
 - Straighten edges of balsa sheeting
 - Precision straight edge for drafting
 - Straight edge for checking alignment
 - Special "open coat" sanding surfaces for balsa and styrofoam
- "A valuable tool for the particular modeler"



SEND TO
DELTA SPECIALTIES
P.O. Box 754
Bridgeton, Mo.

BILL CAMPBELL

JACK CAMPBELL

(Mo. Residents add 3% sales tax)