

THE LORELEI: FULL SIZE PLANS INSIDE

CDC

# radio control

APRIL 1965 50¢

*Modeler*

AMERICA'S LEADING PUBLICATION FOR THE WORLD'S FASTEST GROWING HOBBY



**RCM Product Report:  
THE BONNER DIGIMITE**

**By Don Mathes: RCM's  
CONVERTIBLE SUPERHET**

**A BONUS ISSUE FOR  
THE R/C BEGINNER!**

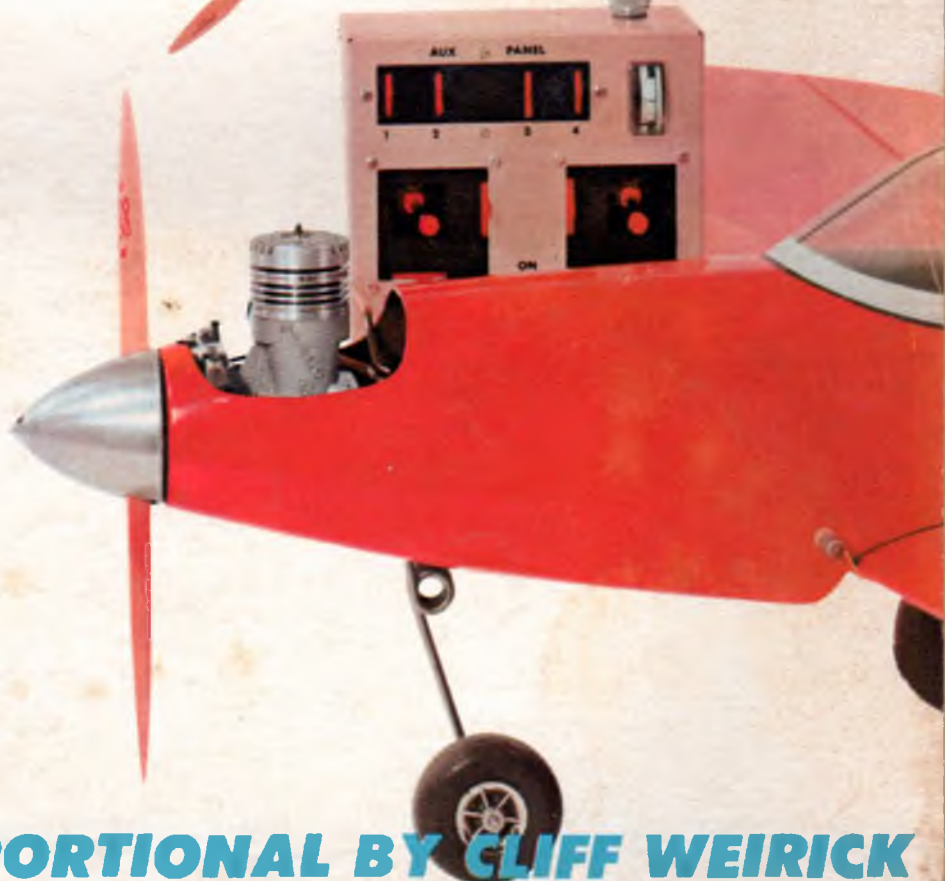

**HOW TO FLY PROPORTIONAL BY CLIFF WEIRICK**

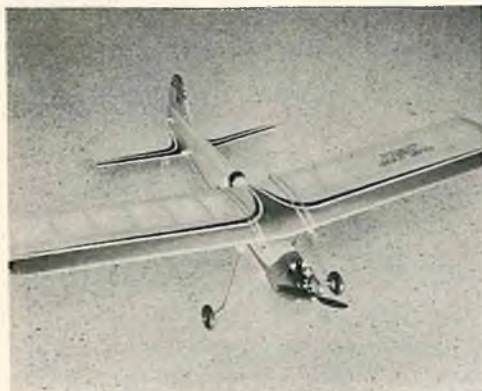

PAGE 21



PAGE 16



PAGE 32

## FEATURES

---

<b>An Approach To Flying Proportional</b>	<b>12</b>	Part I / Cliff Weirick
---	-----------	------------------------

---

<b>RCM's Convertible Superhet</b>	<b>16</b>	Miniature superhet for single or six / Don Mathes
-----------------------------------	-----------	---

---

<b>The Lorelei</b>	<b>21</b>	Full size plans for a small-field sport rudder only design
--------------------	-----------	--

---

<b>The Bonner Digimite</b>	<b>30</b>	RCM Product Report
----------------------------	-----------	--------------------

---

<b>Kwik-Fli II</b>	<b>32</b>	The nation's hottest Class III contender / Phil Kraft
--------------------	-----------	---

---

<b>The Babcock</b>	<b>27</b>	<b>36</b> RCM Product Report
--------------------	-----------	------------------------------

---

<b>Flaps: And How To Use Them</b>	<b>41</b>	Part II R/C Aerodynamics / Alan Wall
-----------------------------------	-----------	--------------------------------------

---

## DEPARTMENTS

<b>Editor's Memo</b>	<b>6</b>
<b>Tech Queries</b>	<b>8</b>
<b>Showcase '65</b>	<b>32</b>
<b>Kits and Pieces</b>	<b>37</b>
<b>N.A.R.C.C.</b>	<b>38</b>
<b>Top Out</b>	<b>43</b>
<b>Roostertail</b>	<b>45</b>
<b>Classified</b>	<b>66</b>



### COVER

Proportional flying for sport or competition — and a pair of fibreglass beauties. Upper left: RCM Editor Don Dewey's Glasquire with Kraft Proportional. Lower right: Chuck Waas's Candy and Bonner Digimite proportional system.

Ektachrome by J. Allen Hawkins, Pasadena, Calif.

# RADIO CONTROL MODELER

Editor  
DON DEWEY

Production Editor  
CHUCK WAAS

Technical Editor  
DON MATHES

Art Editor  
Dick Kidd

Contributing Editors  
Ken Willard  
Frank Justin  
Jerry Kleinburg  
Gary Preusse  
Bernie Murphy

Foreign Editor  
Cliff Rausin

Contributing Photographers  
Gil Duarte  
Dick Tichenor

Special Projects  
Bill O'Brien

Administration  
Sharon Blanchard

Editorial Assistant  
Sally Dewey

Reader Service  
Shirley Byers

Foreign Correspondents  
Geoff Franklin, England  
Bill Murray, Canada  
Monte Malherbe, South Africa  
Per-Axel Eliasson, Sweden  
Claude Bernard, France  
John J. Carroll, Ireland  
Windy Kreulen, Holland  
Mario Sabbadin, Italy  
Yuji Oki, Japan

R/C MODELER CORPORATION, Publisher  
Editorial and Advertising Office  
P.O. Box 487  
Sierra Madre, California 91026  
Phone (213) 356-1066  
Business and Circulation Office  
P.O. Box 1128  
Laguna Beach, California 92652  
Phone (714) 494-0768

Subscription service: All subscription correspondence should be addressed to R/C Modeler Circulation Dept., P.O. Box 1128, Laguna Beach, California. Please allow at least six weeks for change of address. Include your old address, as well as new — enclosing an address label from a recent issue whenever possible.

Editorial contributions: must be accompanied by return postage and will be handled with all reasonable care. Publisher assumes no responsibility for return or safety of art work, photographs, or manuscripts. Address editorial contributions to The Editor, R/C Modeler Magazine, P.O. Box 487, Sierra Madre, California.

Subscription rate: One year, \$5.50, 2 years \$10.00. Canada, one year \$6.00. All other countries, one year \$6.50. Payment from all countries must be in U.S. funds.

R/C MODELER MAGAZINE is published monthly by the R/C Modeler Corporation. Contents copyright 1965. All rights reserved. Printed in U.S.A. Second Class Postage paid at Milwaukee, Wisconsin and at additional mailing offices.

Official Publication Of

The National Association of Radio Control Clubs  
International Model Power Boat Association  
National Miniature Pylon Racing Association

## EDITOR'S MEMO

by DON DEWEY



*At a time when radio control is attracting more and more adult members of our society to its ranks — a great majority of them non-modelers — when this hobby is growing by leaps and bounds, it is time for a re-evaluation of the directions we are taking and the goals we hope to attain. In a current issue of one of the national model magazines, the Builder of the Model Rule is upheld and defended — a ruling which has not only served as a tremendous deterrent to this hobby, but one which has severely discouraged many would-be contestants from entering active local or national competition. We had hoped that this ruling would have died by its own inherent decadence. It is not expected of a general model publication to keep its finger continually on the pulse of any one specialized phase of model aviation — but to champion a cause such as this not only insults the intelligence and integrity of the adult modeler, but provides a disservice to this largest single segment of model aviation. It is all right to be nostalgically reminiscent of the “good old days,” but to actively campaign for a return to the gas tube era does little good for anyone concerned. In order that this recent flailing of a rubber sword in defense of a dying dragon may not be construed as representative of the thinking of the entire RC fraternity, we present the following editorial, “Whither The Sport,” written for RCM by this month’s guest editorialist and active RC’er, Robert C. Lien, M.D., Assistant Professor of Surgery at Tulane University.*

**T**HE ART AND SPORT of RC has advanced at a tremendous rate during the past several years. The reasons for this growth are not difficult to discern. Reliable equipment and prefabrication have played major roles in this development. The difference between a Sunday afternoon at the field now and five years ago is so striking as to be almost unbelievable. Think back, and we think you will agree. We can only speculate as to what lies five years in the future, but if growth of the sport is only maintained at its present rate, it is conceivable that well over half a million individuals will be actively engaging in flying RC by 1970.

It is inevitable and natural that any growing sport or hobby will develop a set of problems peculiar to itself. At the present time this is all too true of our mutual pastime. Possibly one detrimental aspect of our present-day system of living is that we feel strongly about all too few things. We are so numbed by the bombardment of world events besetting us, and the conflicting opinions resulting therefrom, that it becomes a virtual impossibility to attain, or maintain a strong opinion towards any one thing. In this area of our private and mutual hobby, it is possibly easier to develop opinions, and therefore we seize on these fields of contention with a relatively forceful grasp, giving vent to feelings and

opinions on subjects where we feel there is some chance of being heard, if not heeded. Listen at any gathering of ardent RCers and we think you will understand what we mean. Is anyone more vociferous in his damnation or praise of Democrat or Republican than the RCer with an opinion on the merits or shortcomings of a particular brand of radio? Where else in this country can we find such pleasure in expression of opinion as in a discussion of Taurus vs. Beachcomber, or the merits of Class I as a contest event? It is possible the outcome of such discussions will not shake our foreign policy, or aid in the war on poverty (RC has a way of inaugurating some degree of poverty anyway), but the important thing remains — the individual is participating. Whenever an individual participates, he gives of himself, knowingly or unwittingly. It also follows closely that a participating, giving person is beneficial in any endeavor, whether it be vocation or avocation.

There are precious few things left in this century of ours where a man can gain satisfaction by the craftsmanship of his hands, the coordination of mind, eye and hand. The major reason that RC is going to continue to grow is because it satisfies just this type of basic human urge. Tuning the family car, or neatly edging the side-

*(Continued on Page 62)*

# VECO QUALITY

## KITS



Jim Kirkland's  
**BEACH COMBER**

The most complete RC kit you can buy for standard or proportional RC. Perfect for training or contest flying. Simplified construction includes precision die-cut full-size fuselage sides, 4" wing balsa, complete hardware package including nose gear, Nylon bell cranks; full-size detailed plans showing receiver, servo and mechanical installation of three RC equipment options. See the Beach Comber at your dealer. R-5.....\$29.95

## ENGINES

### Veco 45RC



Power your new Beach Comber, or any other large RC ship, with the Veco 45RC, the engine that has been used by more national and international contest winners than any other engine. The Veco 45RC is the choice of experts for full-range power and reliability for sport or contest flying.

bore .850 • stroke .820 • displacement .465  
• safe idle 2000 rpm • coupled exhaust/  
intake throttle control

Send for our free booklet, "How To Obtain Reliable Idle & Maximum Performance From Your VECO 45RC," by Clarence Lee.  
GP-45RC .....\$34.95

## FUEL

### Veco Power Fuel 1

Here is the fuel to insure optimum performance for your Veco engine. Veco Power Fuel 1 is blended to provide even-burning-power from idle to maximum RPM. And it lubricates your engine efficiently for long-life and trouble-free operation.

The perfect fuel for R/C •  
Free-Flight • C/Line

95c/pint    \$1.65/quart    \$5.95/gallon



Ask for VECO products at your hobby dealer  
... engines • engine accessories • tanks  
• wheels • spinners • hardware/send 10c  
for 1965 catalog.



**VECO PRODUCTS CORP.**  
P. O. Box 229, Burbank, Calif.  
a subsidiary of Henry Engineering Company  
MP65403

# T E C H Q U E R I E S



**DON MATHES**

Questions for TQ should be addressed to the Technical Editor, R/C Modeler Magazine, P.O. Box 487, Sierra Madre, California. Please enclose a stamped, self-addressed envelope for reply.

**Q.** Is it possible to hook up a pulse proportional motorized actuator, such as the Micro Mo, for use with a single channel relayless receiver without adding a relay?

**BILL ADAMS**

Trenton, N.J.

**A.** Yes, but not without circuit modifications applicable to the individual receiver in question.

**Q.** Is there any advantage to adding 'fail-safe' to a reed rig, such as used on the new proportional systems?

**WELDON BELLER** Los Angeles, Cal.

**A.** 'Fail-safes' used on most new proportional systems are almost as complex as a complete reed rig. Reed systems are inherently self-neutralizing, thus providing a return-to-neutral 'fail-safe.' The very narrow bandwidth characteristics of the reed bank provide effective filtering of noise, etc., that proportional receivers do not.

**Q.** What does a field strength meter actually tell you?

**LOUIS ARDEN**

Chicago, Illinois

**A.** A field strength meter (FSM) measures radiated, or RF output. It is useful for comparison of the relative power output between transmitters of different manufacture, and also for transmitter tuning. It is well to note that most FSM's are square law devices. For example: An FSM measures one-half scale at a distance of fifteen feet with a given transmitter. At a distance of thirty feet, however, four times the RF power would be needed for the same reading.

**Q.** I would like to convert my 9 volt six channel transmitter to a nicad

power supply. What size nicads should I use?

**DON CONLEY**

Phoenix, Arizona

**A.** 500 Mah sintered plate nicads should be used.

**Q.** Should a beginner in rudder-only such as myself attempt to build some of the ultra-small quarter and eighth-A kits currently available?

**VIC SOBRINSKY** Alhambra, Calif.

**A.** No. Generally speaking, airplanes of the ultra sub-miniature size are more of a novelty than anything else. As such, they are not very practical and usually weigh substantially more than they are supposed to, resulting in a glide angle equivalent to a well streamlined brick. If you must build this size ship as a "starter," our recommendation is Top Flite's "School-boy," designed by Ken Willard.

**Q.** I've read that Galloping Ghost is a poor man's proportional. Is this an economical yet practical method of obtaining proportional control?

**ERNIE TIPTON**

Toledo, Ohio

**A.** The key word in your question is "practical." Most GG's I've seen or flown look like a wounded duck in mating season. If you have the inclination to spend many hours tinkering and a very few hours flying, this is for you.

**Q.** What is the best solution for cleaning flux off of a printed circuit board?

**RICHARD PALMER** Seattle, Wash.

**A.** Trichlorethelene, obtainable at any chemical supply house. In emergencies, use acetone or plain old dope thinner. Use any of these with ade-

(Continued on Page 10)

**CLOCKWORK TIMERS**

1/2A TICK OFF, fuel shut off .....	\$4.50
TICK OFF, fuel shut off .....	4.50
1/2A FLOOD OFF, pressure release .....	4.50
FLOOD OFF, pressure release .....	4.50
D-T TICK OFF, dethermalizer .....	4.50
TIME EXTENDER DISC, for D-T .....	.85
SURGICAL TUBING .....	per ft. .20

**RADIAL-BEAM ENGINE MOUNTS**

Tee Dee .049, short or long beam .....	\$1.50
Class .09, short beam only .....	1.75
Class .15, short or long beam .....	1.75
Class .19, short or long beam .....	1.75
Class .29-.35, short or long beam .....	2.00
Class .45-.60 medium beam only .....	2.50
McCoy-Rossi .60, long beam only .....	3.00

**TANK-MOUNTS**

Tee Dee .049, short beam only .....	\$2.85
Class .15, short beam .....	3.00
Class .15, long beam .....	3.00
Class .19, short beam only .....	3.00
Class .29-.35, short beam only .....	3.50

**SCALE INSTRUMENT KITS**

Sizes (rim dia.) 1/4, 5/16, 3/8, 7/16, 1/2...Ea. \$1.75

**SPEED PANS**

Class 1/2A .....	\$3.50
Class A .....	4.25
Class B .....	4.50
Class C .....	4.95
PROTO, half pan—A.M.A. class .....	3.95

**R/C NOSE GEAR KITS**

R/C BELLY MOUNT .....	\$4.95
R/C BULKHEAD MOUNT #1 .....	4.95
R/C BULKHEAD MOUNT #2 .....	4.95
R/C ENGINE MOUNT NOSE KIT .....	5.95

**ADJUSTABLE PITCH PROPELLERS**

10" Dia. "INSTANT PITCH" .....	\$1.95
11" Dia. "INSTANT PITCH" .....	1.95
Replacement Blade, 10" .....	.65
Replacement Blade, 11" .....	.65

**A.M.A. SAFETY RULE PROP NUTS**

1/4" prop shaft diameter .....	\$.85
5/16" prop shaft diameter .....	.85

**OTHER ITEMS**

R/C, U-CONTROL HINGES .....	pr. \$ .34
GLIDER WINCH .....	5.50
STOP WATCHES, 1/10 or 1/5 second .....	12.95
LAP COUNTERS .....	5.95

COMING SOON . . . MORE GOODIES FOR '65

AT BETTER DEALERS EVERYWHERE

If no dealer is convenient, send check or money order. Overseas modelers add 15% for Air Mail return.

Send 10¢ for descriptive catalog

**TATONE PRODUCTS**

1275 GENEVA AVE.  
SAN FRANCISCO, CALIF. 94112

Circle No. 105 on Reader Service Card

**Tech Queries**

(Continued from Page 8)

quate ventilation and apply to the PC board with a stiff-bristled acid brush.

**Q.** I am a beginner in RC — if cost is not too much of a factor, where would you suggest starting out in this hobby? Is it still considered necessary to work up to the top via the single channel route?

**MICHAEL DIXON** Vancouver, B.C.

**A.** In my opinion, single channel has still not advanced to the point where it is more than a free flight with occasional radio interference. My personal formula for the beginner is a six channel radio with Bonner, Ancco, or Royal MK servos. In general, the end result will more than offset the difference in cost.

**Q.** What different makes of single channel servos would you recommend for bang-bang and for pulse rudder?

**ELDON LARKIN** Anchorage, Alaska

**A.** For so-called "bang-bang," or selective rudder and motor, we recommend the Royal or Sankyo single channel servos. Both are excellent and add a great deal of reliability to single channel that cannot be obtained with escapements. The Sankyo requires four pencils for the two servos and the Royal three. The Sankyo is smaller and features a dual output for use on aileron-only or rudder and steerable gear. It is slightly faster than the Royal. Both weigh approximately the same and sell for approximately the same price. Either one will do the job. For pulse rudder, we recommend the Minipulse by Accutronics Engineering, a subminiature unit with exceptional power that provides proportional rudder and trimmable motor, or the Tomoser actuator which is more economical but does not provide the trimmable throttle feature.

**Q.** Should a beginner in multi choose an aileron ship for his first airplane?

**VERN ECKSTROM** Pasadena, Calif.  
**A.** The added complexity and building time of an airplane with ailerons is generally not justified for the beginner.

**Q.** Can a newcomer to this hobby, with somewhat limited electronics experience, attempt to build some of the kits available for single channel

transmitters and receivers?  
**WILL DAWSON** Miami, Florida

**A.** Yes, but unless you have a real yearning to be a "do-it-yourselfer" I would recommend that the newcomer purchase commercially available and factory tested radio equipment. The cost of the completed unit is usually only slightly higher than most kits, not to mention the savings in time and frustration.

**Q.** Our local field has a dirt and closely-mowed grass surface. Which would be best for multi sport flying — trike or conventional gear?

**L. T. LEWIS** San Antonio, Texas

**A.** Two wheel, or conventional gear, is considerably less complex and not overly prone to damage on rough fields. A tricycle nose wheel is vulnerable, however either should be very satisfactory if thin, large diameter wheels are used.

**Q.** What are the pro's and con's for the different type of servo outputs utilized by the various proportional manufacturers, e.g., the Orbit "wheel," the linear push-pull as used by Kraft, and the top-of-servo linear travel utilized on the Bonner Digimite?

**HANK WALKER** Buffalo, N.Y.

**A.** This is primarily a matter of user's preference. Each type has its advantages and disadvantages. The "wheel" output is easiest to produce from a manufacturer's standpoint and is perfectly satisfactory as long as the total arc traveled is kept to a minimum. In addition, they are easily reversible simply by shifting the linkage from one side of the wheel to the other. The "push-pull," or so-called linear motion, provides non-linearity (slower neutral), and is relatively easy to reverse mechanically. It does, however, generally take up more space than the other two. The Bonner type servo output is our particular preference, combining the best features of the other two with no major drawbacks. I would personally like to see a servo with both a wheel and a rack output for complete ease of installation and flexibility.

**Q.** Some of the new proportional rigs have a throttle trim function, others do not. Is the necessity for this feature simply a matter of opinion?

**RAY TROTTER** Milwaukee, Wis.  
**A.** Yes.

## **An Approach To**

# **FLYING PROPORTIONAL**

**by Cliff Weirick**

*RCM offers its readers a few hours of ground school and dual stick time with the 1964 Nationals winner and top contender for the World R/C Championship.*

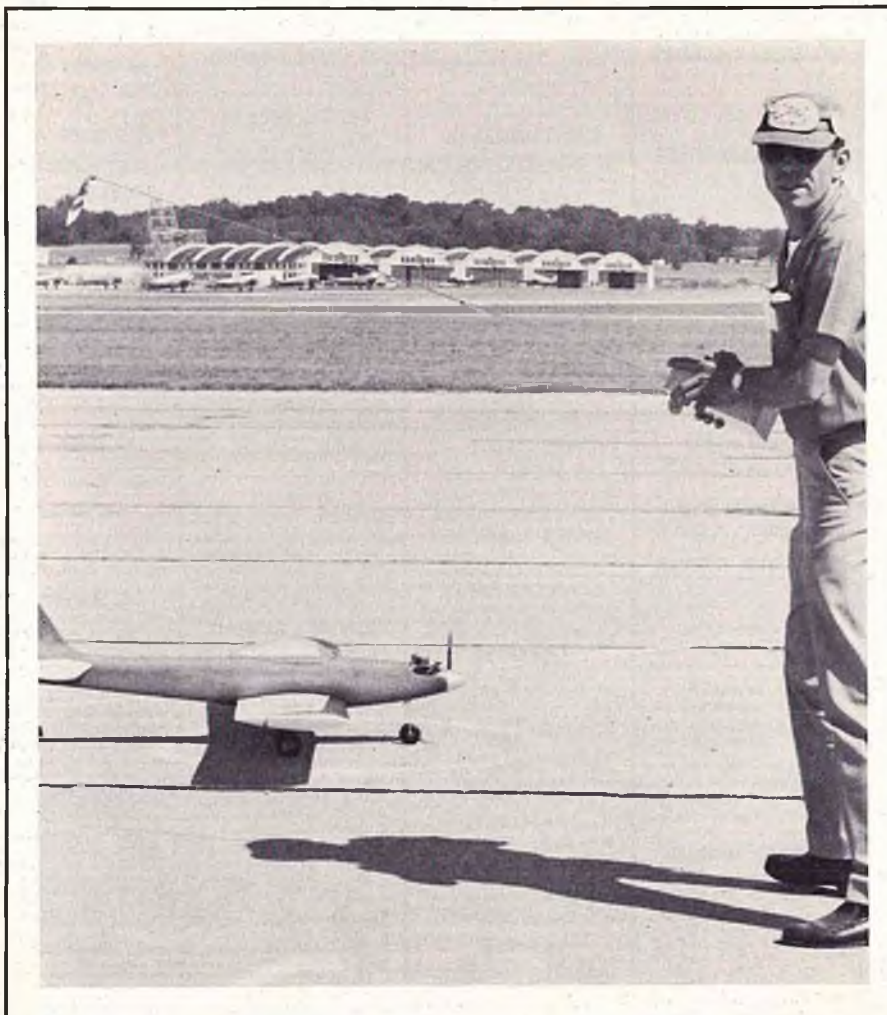

When I was asked to write an article on how to fly multi proportional, I agreed, thinking to myself, "Boy, that will be a snap!" Since then I have given it considerable thought and have found that it is not so easy to explain on paper. It is no problem to fire up my Sugar Tigre, take off, run through the pattern, land and then shoot the breeze with the troops. But how does one put all this down on paper and expect a person to read it and really be helped by what he has read. I have read many articles on how to do it "in 10 easy lessons", but they always left many things to be desired. Therefore, in a sincere effort to be helpful, especially with the help of Willie Smith and many others, have tried herein to cover a few of the aspects of flying multi proportional.

A lot of fliers believe that proportional control will automatically correct for any mistakes in the airplane itself. This is not true, by any stretch of the imagination. The model must be just as true as any reed ship should be, or even better. I like to look at in this way — your flying will be as good as the weakest link in the system. Therefore, everything must be as good as you can possibly make it. So, before you get into the flying end, let's take a good look at your model.

First of all, it is my opinion that any model that will fly well with reed equipment, should fly equally well, or better, with proportional controls. I might recommend a few kits that are on the market that will make real good trainers for the beginner. These are the Senior Falcon, the Mighty Mambo and the Smog Hog, not necessarily in that order, because one is equally as good as the other. They are all rugged airplanes, inherently stable and should keep you out of trouble if you goof.

A few remarks about the construction: As I said before, the airplane should be true and free of warps. One thing that is very important in proportional control is your linkage. All linkages should operate smoothly and easily. There should not be any excess play in your hinges or the fittings, etc. Another thing that is important is that there should be no metal-to-metal contact in your linkage if you can possibly keep from it. I strongly recommend the use of nylon Clevis fittings and/or nylon control horns.

*(Continued on Page 14)*

At this point in the building of your model, there is a decision that you, as the flier, must take. That is, are you going to fly it "full house" right off the bat, or are you going to use rudder, elevator and throttle? I would recommend flying rudder, elevator and throttle until you are really capable of three axis control. Believe you me, ailerons **can** get the beginner in a lot of trouble real fast!

Now that you have made your decision and the model construction is to the point that you are now ready to install the radio equipment, let's take a good look at the installation itself. We have a receiver, a battery pack and three or four servos, as the case may be. Where do we put them all? I, for one, always put the battery as close to the front of the airplane as possible. Can you imagine losing control and watching the airplane diving into the ground with the battery pack **BEHIND** the servos and receiver? Boy, that heavy monster really runs hob on its way to the nose! So, let's put the battery in the nose section, the receiver behind the battery and the servos behind the receiver. If you look at the plans, you will find that almost all manufacturers follow this line of thought. Pay real good attention to what they say on the plans. They have spent a lot of time and thought drawing these plans and their suggestions should **not** be disregarded.

Most proportional radios come to you pre-wired and can be simply installed in the airplane, turned on, and operated. However, if wiring is required in any case, the following suggestions might help you to get off to a good start. Use electrical spaghetti wherever possible over connections. Make good solder connections. And when I say "good solder connections", I mean connections that are bright and shiny. If the connections have a dull silver look, they are "cold" connections. If you fly with "cold" connections, you can almost certainly kiss that model good-bye.

Another thing to consider is to use strain relief in your wiring wherever possible. Don't pull the wire too tight and don't support anything with your wiring. I strongly recommend a good knife-type slide switch such as sold by Ace R/C or Bonner Specialties. Do not use any type of button switch. These often cause intermittent action due to vibration. As a rough guess, I would say that almost 90% of equipment malfunction is due to wiring

errors by the beginner or the expert, including myself. So, read your "destruction" sheet carefully and do exactly what it tells you to do. Again, the radio manufacturers as well as the kit manufacturers have spent many, many hours trying to keep you from making mistakes and to give you the greatest possible enjoyment out of your radio control system.

Another item that is very important is to keep your antenna as far away as possible from other wiring and electrical equipment such as your servos or any type of electrical motors you may have in the airplane. I, personally, run my antenna out through the top of the fuselage directly above the receiver and then run it back to the top of the fin. Do not attach the antenna directly to the fin but use a rubber band. This is to avoid tearing the antenna out of the receiver or tearing up the fin on your airplane should you ever bump into the antenna. A lot of guys like to run the antenna down and out the bottom of the airplane. To do this, however, they have to run it parallel to the wiring and the servos and this is not good — **in any way, shape or form**. I believe it's been quite a few years since anyone has seen an automobile antenna hidden underneath a car!

Now that you've got everything installed, let's check the radio out. Read the radio manufacturer's instructions very closely at this point to see what he has to say about the equipment check-out.

1) Do all your controls move in the proper direction relative to your stick motion? i.e., if I move the aileron stick to the left, do I get left aileron? And so on down the line. You'd be surprised at how many guys take off with the aileron backwards. Boy, is that a ball!

2) The next check. When your sticks are in neutral, are your controls also in neutral? If not, make sure that the servos are in neutral and then mechanically put their associated surfaces in neutral also.

3) Now that all the controls are working just fine and the neutral adjusted, let's do a range check. This should be performed according to the radio manufacturer's recommendations. Do it exactly as he says in the "destruction" manual.

Remember, at this point, that these checks should not be performed around a bunch of electrical equipment such as refrigerators, deep

freeze units or any of the normal electrical appliances that are found around your home. Fluorescent lights are a real bugaboo for R/C equipment.

Get the set out in the street or an open field to perform these checks. Have someone help you. When you have attained the approximate range that the manufacturer says it should have, repeat this check with the engine running. The engine should be at full throttle and the model supported by rubber bands slipped over the wings. This will check for vibration which, as most R/Cers know, can really raise hob with a reed radio. It can also bother proportional. The big thing here is to check for any metal-to-metal contact than can generate electrical noise which really looks great to a superheterodyne receiver. If you notice any marked reduction in antenna-off range, I suggest you check for the following:

1) Any metal-to-metal contact such as linkage, pushrod rubbing against the receiver case, loose engine mounting, loose metal hinges. These are all good noise generators.

2) Check for poor solder connections in the wiring, in the switch, the battery pack or the equipment. (I realize that you cannot check into the equipment too deeply, but should you find the source of the trouble is in the receiver or the servo, I would strongly recommend that you return the radio to the manufacturer explaining what you have found and what you believe the trouble to be.)

Now, assuming that everything has checked out as it should, put the batteries on charge and walk away and forget about it for today.

TIME: The next morning.

Let's go fly our super-duper toy. (We, hope!)

Now we're at the field. Nervous? You bet! But let me caution you. Don't let nervousness cause you to make mistakes. Check everything over again very carefully. Check with other fliers to find out what frequency you are on. You don't become very popular if you turn your radio on and cause someone else to crash. In addition, fly a color frequency flag on your transmitter. This is for your own protection as well as other fliers.

At this point try to enlist the aid of an expert proportional flier, if at all possible. Have him check your model and also do the initial test flight for you. If there is anything

(Continued on Page 61)

# RCM'S CONVERTIBLE SUPERHET

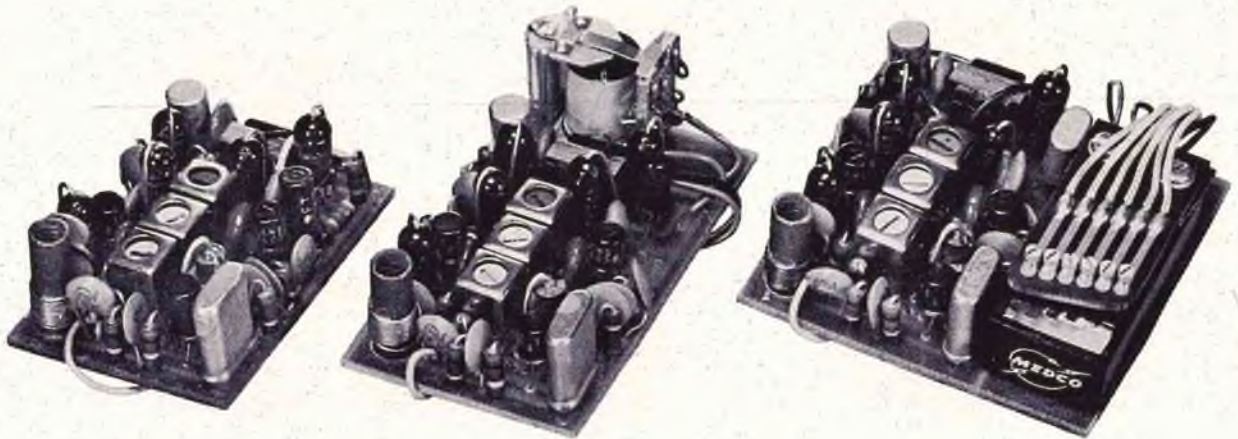

*One of the most outstanding and versatile receivers ever designed, RCM's Convertible Superhet is intended for single channel relayless, relay, or 6-channel installations.*

**By DON MATHES**  
RCM Technical Editor

The widespread demand for a miniature superheterodyne receiver resulted in a staff assignment to the RCM Technical Department to develop such a unit, having the advantages of small size, ease of construction, and wide operational flexibility. Although several designs incorporating one or more of these features have been developed in the past, this circuit has the added advantages of both simplicity and versatility. It is designed for use as a truly miniature, lightweight relayless receiver for single channel operation in the .01 class, or as a relay receiver for single channel servo or pulse operation with actuators such as the Royal, or Sankyo single channel servo, Accutronics Minipulse, S.E.P. Go-Ac, Tomoser PA-1R, etc. A further design consideration in the development of this unit permits the installation of a standard six channel Medco reed bank for multi superhet operation. The photographs accompanying this article illustrate a few of these various combinations, including a 36" span, six channel ship utilizing Annco servos.

## **General Description**

Performance measurements indicate that overall performance of the RCM Superhet is comparable to most com-

mercially available transistorized receivers, and in fact, surpasses many of them. Field tests indicate that this unit operates very well with regard to adjacent channel interference and temperature variations.

As shown in the block diagram, the receiver is broken down into four separate sections. The first is the detector, wherein the incoming RF signal is received and converted to a suitable frequency for amplification. The second section is the Intermediate Frequency amplifier which is tuned to the difference between the transmitter and receiver crystals. The next section is the demodulator, or Second Detector, which extracts the audio information as it was initially sent from the transmitter. This information, still at a rather low level, is coupled to the Audio Amplifier, and in turn, drives the appropriate power stages for operation of the various actuators. These stages will now be described in detail in order to give the reader a better understanding of the superheterodyne receiver.

The Detector stage is rather unconventional in this case, inasmuch as an autodyne converter is employed in order to reduce both physical size and overall complexity. The autodyne con-

verter can best be described as a combination local oscillator, mixer, and IF amplifier. This operation gives a conversion gain somewhat lower than would be obtained with the same transistor as a separately excited converter. In our application, this is more than offset by the savings in components and complexity. Perhaps one of the greatest difficulties encountered with autodyne converters is a tendency to stop oscillating under very high signal strength conditions. This circuit has been designed to decrease this difficulty. As an example, the transmitter and receiver antennas may be as little as one foot apart with no problems of this nature. It is seen, however, that AGC is not applied to the converter, and that the operating point of the transistor is stabilized by an emitter bias resistor. In addition, relatively low base bias impedances and short time constants decrease the problem to an acceptable minimum.

The transmitted radio frequency signal is detected through tuned circuit L1 and amplified between base and ground of the converter. The Intermediate Frequency output is taken at the collector. Feedback for the local oscillator portion of the converter occurs from the collector to base



through the crystal. The transistor is biased in a relatively low current region, thus evidencing quite non-linear characteristics. The latter enables the incoming signal to mix with the oscillator signal present, creating signals of the following four frequencies: (a) the local oscillator signal (b) the received incoming signal (c) the sum of a and b (d) the difference between a and b.

The I F transformers are tuned here to the difference between the local oscillator and the incoming signal frequencies. This frequency is called the Intermediate Frequency, or IF, and is 455 Kc. This frequency will be maintained, since both transmitter and receiver oscillators are crystal controlled. It is worthwhile to note here that crystals in the transmitter and receiver are separated in frequency by 455 Kc. For example, a transmitter with a frequency of 26.995 will match properly a receiver whose crystal is marked 26.540.

Since the emitter is grounded and the incoming signal injected into the base, the mixer section operates in the grounded emitter configuration. Having extracted a 455 Kc signal at the collector of the converter, it is applied to a tap on the IF transformer

to provide proper matching for the stage. The performance of the stage is relatively independent of variations between the transistors specified.

The IF amplifier consists of two grounded emitter stages. These are relatively simple Class A amplifiers. Neutralization was found to be necessary on both in order to avoid common mode regeneration, thereby insuring repeatability and consistent performance.

The Second Detector stage consists of a slightly forward biased diode which operates out of the square law detection portion of the IE characteristics. AGC potential is proportional to the signal level, and is applied through an AGC filter network to the base of the first IF transistor, so as to decrease collector current of the first IF stage at increasing signal levels.

The operating point of the first IF stage is chosen to obtain almost optimum gain at a point where it takes little power to get maximum AGC action.

At this point a brief description is in order as to what is meant by AVC or AGC. Since there is a great deal of variation in range between transmitter and receiver, as applied to

radio control, the need strength around a receiver can vary by several orders of magnitude. Thus, without some form of automatic control circuit, the output power of the receiver would vary considerably, dependent upon its proximity to the transmitter. It is the purpose of AGC, or Automatic Gain Control, to maintain the output power of the receiver relatively constant despite large variations in signal strength.

Having detected, or demodulated the transmitted intelligence at the detector, the audio derived is coupled to a conventional audio amplifier. This is also a Class A stage with transformer coupling at its output to provide a proper impedance matching. The primary of the transformer is broadly resonated with a capacitor for optimum performance at the desired audio frequency — in this case, approximately 600 cycles. The secondary is coupled to still another grounded emitter stage, which by this time, has amplified the transmitted signal to a point suitable for driving a relay or reed bank. The relay, or reed bank, is used as the collector load, and suitable capacitors are chosen for each to provide the proper filtering.

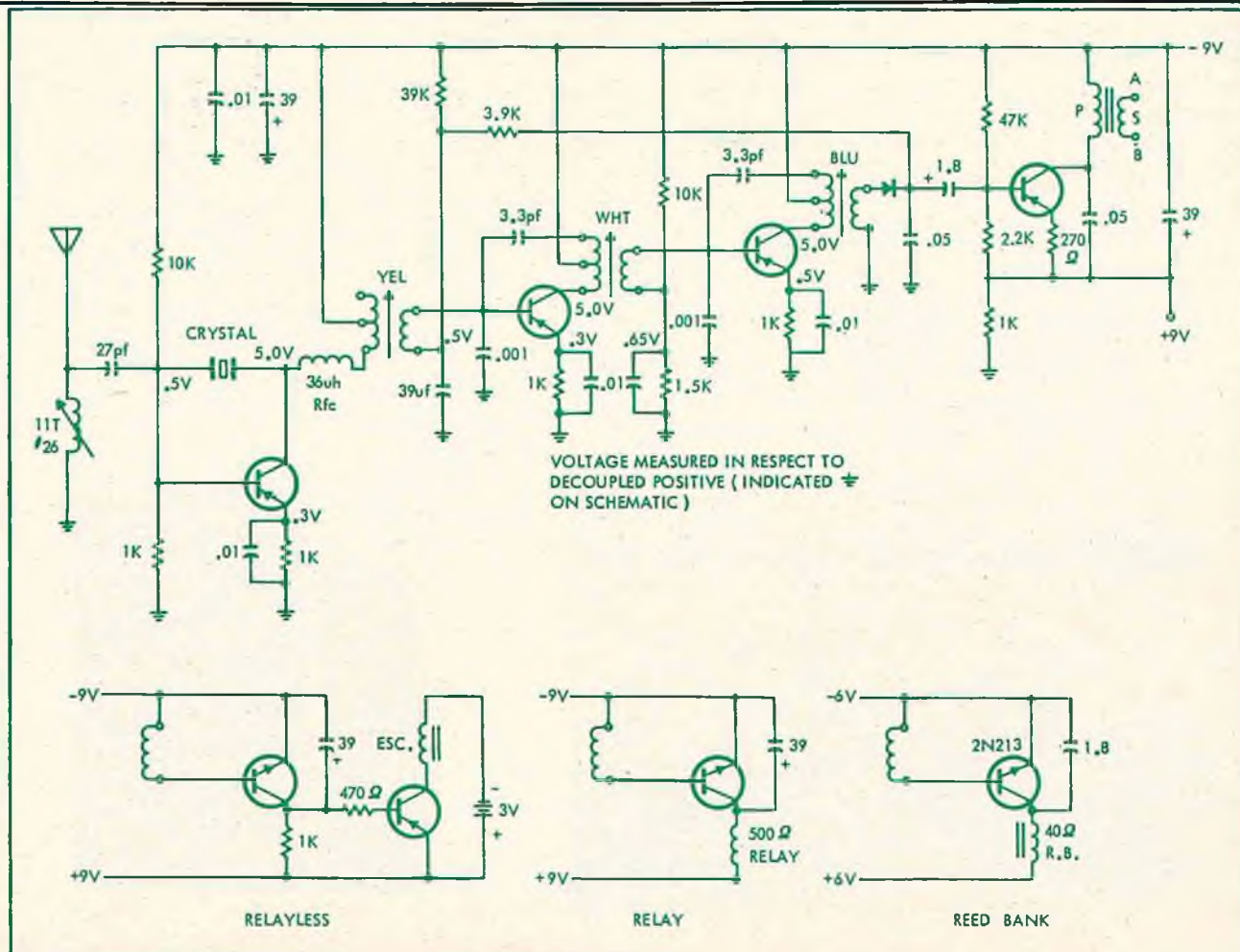



One more stage is added for those who wish to drive a standard escapement directly. This is nothing more than a switching transistor which is turned on or off, as desired, by the preceding stage. Any conventional escapement, operating from 3 volts, can be used here, such as the Babcock Mark II, Bonner VariComp, or CitizenShip compound. In the relay and relayless versions, a single 9 volt transistor battery is used for the receiver power. The reason for this is that power supply coupling effects when using motorized actuators are detrimental to optimum receiver performance. On the reed version of the RCM superhet, however, it was found that it could be successfully operated with no difficulty from the standard servo supply — in this case, six volts.

The specifications for the RCM Convertible Superhet are:

- (1) Nominal Sensitivity — 10 microvolts for full control.
- (2) Selectivity — 6 KC at 6 db.
- (3) Supply Voltage — 6 to 9 volts.
- (4) Weight — Relayless, 1 1/8 ounces; Relay, 1 1/4 ounces; 6 Channel, 1 3/4 ounces.

#### Construction

No difficulties should be encountered in the construction of the RCM Super-

het if you have had previous experience in scratch or kit building. Read the instructions through twice, proceed carefully, and use good construction and soldering techniques throughout. The following tools will be needed for assembly: (a) 25-40 watt soldering iron with pencil tip (b) one pair of flush cutting side-cutters (c) one pair of long-nosed pliers (d) one pair of wire strippers.

If you are scratch building this unit, be sure to obtain all components of the proper value. The easiest way to produce the printed circuit board is with the aid of a standard photographic process printed circuit kit, available at most electronic supply houses, some hobby shops, or from World Engines. Follow the instructions exactly and you will encounter no difficulty with this stage of construction.

If you are assembling the receiver from the kit that has been made available, check all components against the parts list to be sure that none are missing. Lay all parts out in front of you and identify them. Begin construction by mounting coil L1 into the large hole in the printed circuit board. Note that this hole has purposely been left undersized so that the coil form may be forced into it, thereby making

a good mechanical connection. Eleven turns of #26 wire is wound around the coil form. Begin by inserting one end into the board, then proceed to wind until you have completed eleven turns, then terminate the other end. The coil is now coated with model cement, such as Aero Gloss or Ambroid, and should be set aside to dry for a few minutes before further work is attempted.

After the cement has dried sufficiently, carefully scrape the enameled ends of the wire as they come through the board so that a good electrical connection can be made. The three IF transformers are now installed, carefully noting the colors of the transformers and their position on the board. Note that the mounting lugs on the transformers share a common hole. The lugs of the transformer are bent over slightly to provide a good mechanical mounting until the soldering operation.

Next to be installed are all resistors. Note that several of these lay flat on the board.

All disc ceramic capacitors are inserted in place, and finally, all electrolytic capacitors. Note polarity of these capacitors. It may be well to

*(Continued on Page 20)*

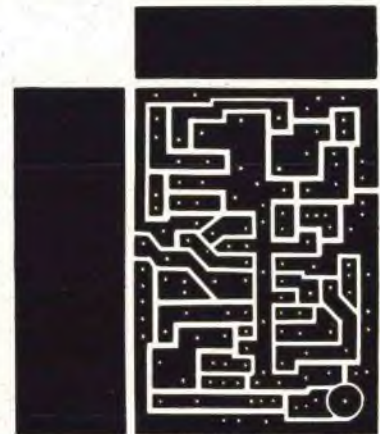

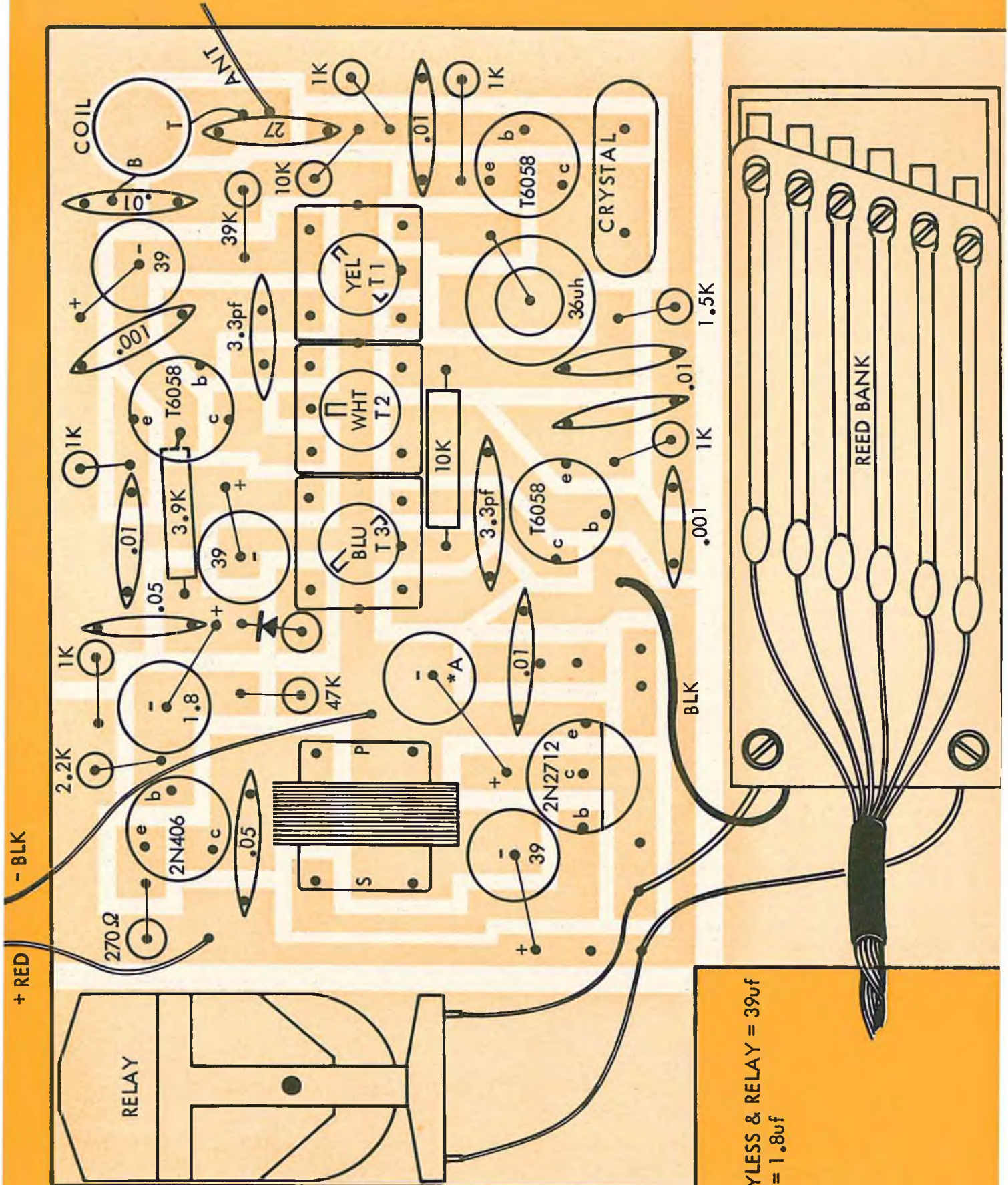

\*A  
 RELAYLESS & RELAY = 39uf  
 REED = 1.8uf

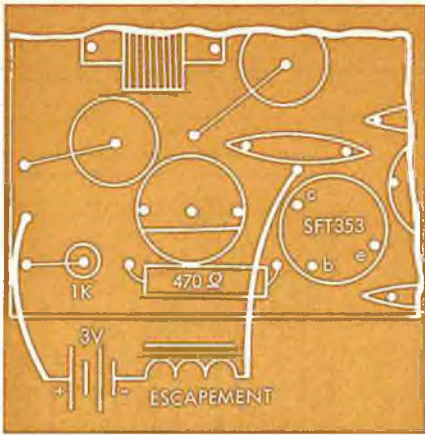

stop at this point and clip the leads on the printed circuit side of the board before it becomes too congested. Note that the lands are quite close together — be careful not to bridge any leads over onto an adjacent land.

The RF choke, transistors, diode, and crystal may now be installed, carefully noting the basing of the transistors and polarity of the diode. The small 10K to 1K transformer is inserted in place at this point. Be sure to install the latter with the "S" on the transformer on the outermost edge of the board.

Install the wires on the receiver, and with reference to the pictorial diagram, the relay or reed bank, if your choice is other than the relayless version. The relayless receiver will have one additional transistor mounted on the board, whereas the relay and reed bank configurations omit this transistor.

All components may be carefully soldered to the board. After completing this operation, all flux should be thoroughly removed with an acid brush and lacquer thinner. Inspect all parts and printed circuit to make absolutely sure there are no parts or leads touching each other. Inspect the bottom of the board for accidental solder bridges. Install an antenna

wire approximately 24"—30" long and you are ready for checkout.

### Alignment

Alignment of the RCM Superhet is begun by first hooking up to the appropriate power supply, carefully noting polarity. Although an oscilloscope is extremely helpful in the alignment of any superheterodyne receiver, a pair of earphones can be used in lieu of the scope. These should be high impedance (2000 ohms or more). In either case, the scope leads, or headphone leads, should be isolated from the receiver with two IF chokes of approximately 20 microhenries inductance. Clip the scope, or phones, onto the test point on the receiver. Turn on a transmitter, making sure that the transmitter and receiver crystals are separated by 455 Kc. The transmitter should modulate 100% at approximately 600 cycles for operation of this receiver.

Depress the tone button on the transmitter and the demodulated audio tone should be heard on the phones, or alternately, seen on the scope. This will be at quite a low level — make sure that the tuning slug in the antenna coil is located approximately half way in the form. When the tone is heard, adjust the IF transformers until they are the loudest. Move the transmitter further away from the receiver and repeat these adjustments until the maximum range is obtained. With the antenna removed from the transmitter for these tests, a range of approximately 10-15 feet will normally operate the relay or escapement, and is more than adequate sensitivity.

When all three IF transformers have been adjusted for maximum signal strength, the core in the tuning coil may be turned in to increase the sensitivity even more. This coil slug should always be kept in the uppermost portion of the form.

If any trouble is encountered, the voltages at all test points are indi-

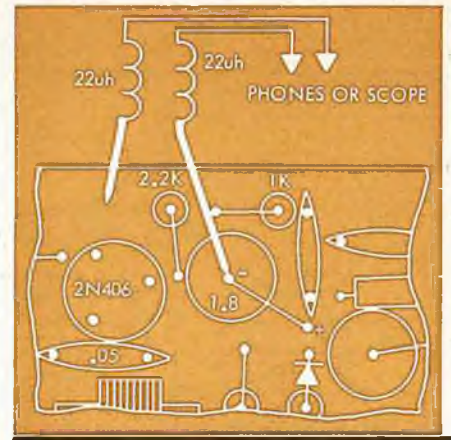

coated on the schematic — these should be within approximately 10-15% of the voltage measured at the receiver. As the receiver is broken down, stage by stage, and isolated by transformers, any problems should be easily isolated. If, after careful testing and analysis, you still cannot obtain proper operation, drop a letter to the Technical Editor, R/C Modeler Magazine, P.O. Box 487, Sierra Madre, California.

### PARTS LIST

270 Ohm ¼ watt 10%	(2) .05 mfd.
2.2K ¼ watt 10%	(4) .01 mfd.
(4) 1K ¼ watt 10%	.001 mfd.
1.5K ¼ watt 10%	.39 mfd.
3.9K ¼ watt 10%	(2) 39 uf
47K ¼ watt 10%	(2) 3.3 pf
(2) 10K ¼ watt 10%	1.8 mfd.
	.001 mfd.
	27 pf

- T1 Mitsumi A7S-A IF Trans.
- T2 Mitsumi A7S-B IF Trans.
- T3 Mitsumi A7S-C IF Trans.

- (1) 2N2712 G.E.
- (3) T6058 Philco
- (1) 2N406 RCA

- 10K—1K Zebra transformer
- 1N34 diode
- 36 uh RFC choke
- crystal (Wright)
- 3/16" dia. CTC coil form

- 1K ¼ watt 10% (relayless only)
- 470 ohm ¼ watt 10% (relayless only)
- 39 mfd (relay or relayless)
- SFT 353 transistor (relayless only)
- 500 ohm Deans relay (relay only)
- 1.8 mfd (6-channel only)
- 2N214 Sylvania transistor (6-channel only)
- 40 ohm Medco reed bank (6-channel only)



Relay single channel version of RCM's convertible Superhet along with several motorized actuators. L to R: Sanyo compound servo; Tomoser proportional rudder actuator; new S.E.P. Go-Ac for Galloping Ghost; Royal compound servo.

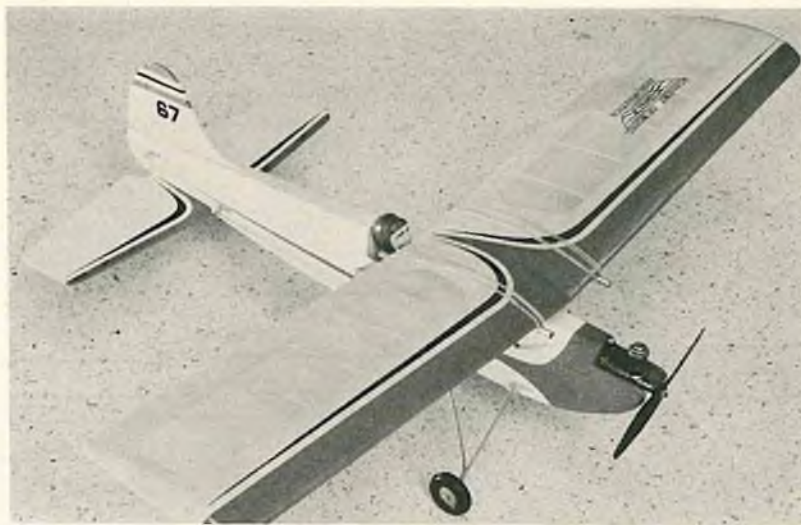

## THE **LORELEI**

FULL SIZE PLANS IN THIS ISSUE

### THE LORELEI: DESIGNED EXPRESSLY FOR SINGLE CHANNEL SMALL FIELD SPORT FLYING

Although R/C Modeler does not normally present staff designs as feature construction articles, this particular plane, the Lorelei, was the result of a two-fold assignment — to evolve a small RC model that was designed specifically for the beginner, and one that would serve as a test ship for the single channel versions of RCM's Convertible Superhet Receiver, presented in this issue.

Certain inflexible pre-requisites were established before actual design work could be commenced. The first was that the model must be designed so as to be presented full size within the physical limits of the magazine itself, eliminating the necessity for ordering plans by mail. In this respect, however, the model was **not** to be of the sub-miniature, or novelty, class, but rather an easy-to-build conventional sized model in the mild .049 category that would incorporate stability, a light wing loading, and slow flying

characteristics. The ship had to be light, yet rugged — designed primarily for flying out of rough, small fields. In addition, it had to look like an airplane. Absolutely verboten was the slab-sided, sheeted cabin, high wing monoplane that has dominated the single channel sport field for so many years.

The actual design effort was tackled by RCM's Tech Editor and Editor at a late midnight session. Since the cabin-type monoplane was ruled out, the first consideration was for a biplane. This idea was discarded due to the poor flying characteristics of most single channel bipes, along with the fact that rough fields wreak havoc with the lower wing. After a few preliminary sketches, plus an evaluation of the pre-requisites established, it was decided to pattern the model after some of the early light-planes of the home built variety — a parasol wing, open cockpit, long nose and tail moments, plus

conventional gear.

Thus, the Lorelei began to take shape...

#### Construction

**General Notes.** Although this is an extremely simple model to build for the more experienced RC'er, **no** model is simple for the beginner. One thing to remember is that many 'a crash could have been avoided if attention had been paid to good building practices and to the small details that go into the construction of every model. The building surface itself is of prime importance. Every construction article informs the modeler to use a flat surface — a **flat** surface does not always turn out to be a **true** surface. We strongly recommend the use of a Magna-Jig for **all** building projects. As an alternate, take a trip to your local lumber yard and purchase a hollow-core door for a building surface. This can be hinged in the middle to serve as a dihedral jig, if you so

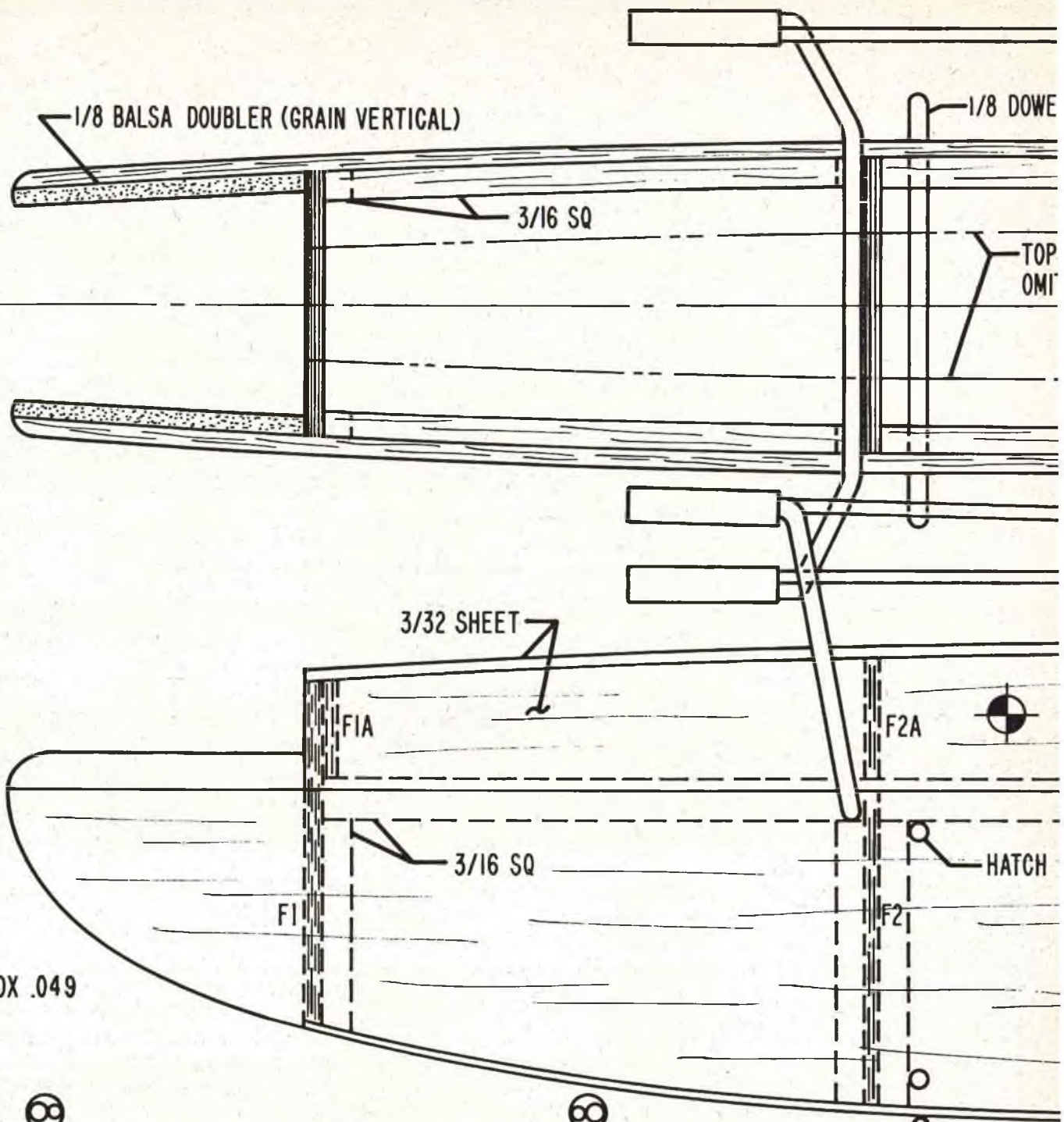

ENGINE - COX .049

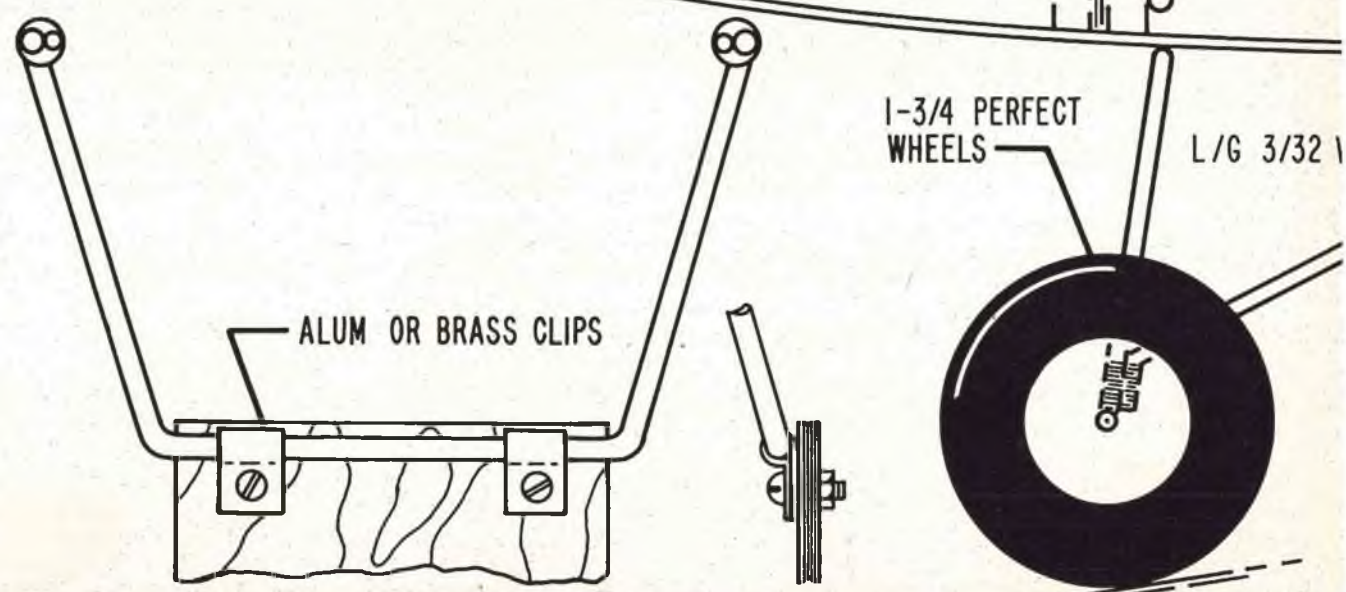

3/32 WIRE

1/8 WIRE

1/4 ID BRASS TUBE

1/8 SIDES

3/16 SQ

ETCHING OUTLINE FOR CLARITY

F4A

3/16 X 1/8 STIFFENER

DOWN DOWEL

ESC. BULKHEAD

F3

F4

F5

1/16 PLY

1/16 SHEET  
GRAIN CROSSWISE

F2A

F1

3/32 PLY

F1A

1/8 PLY

F3  
1/16 PLY

F2

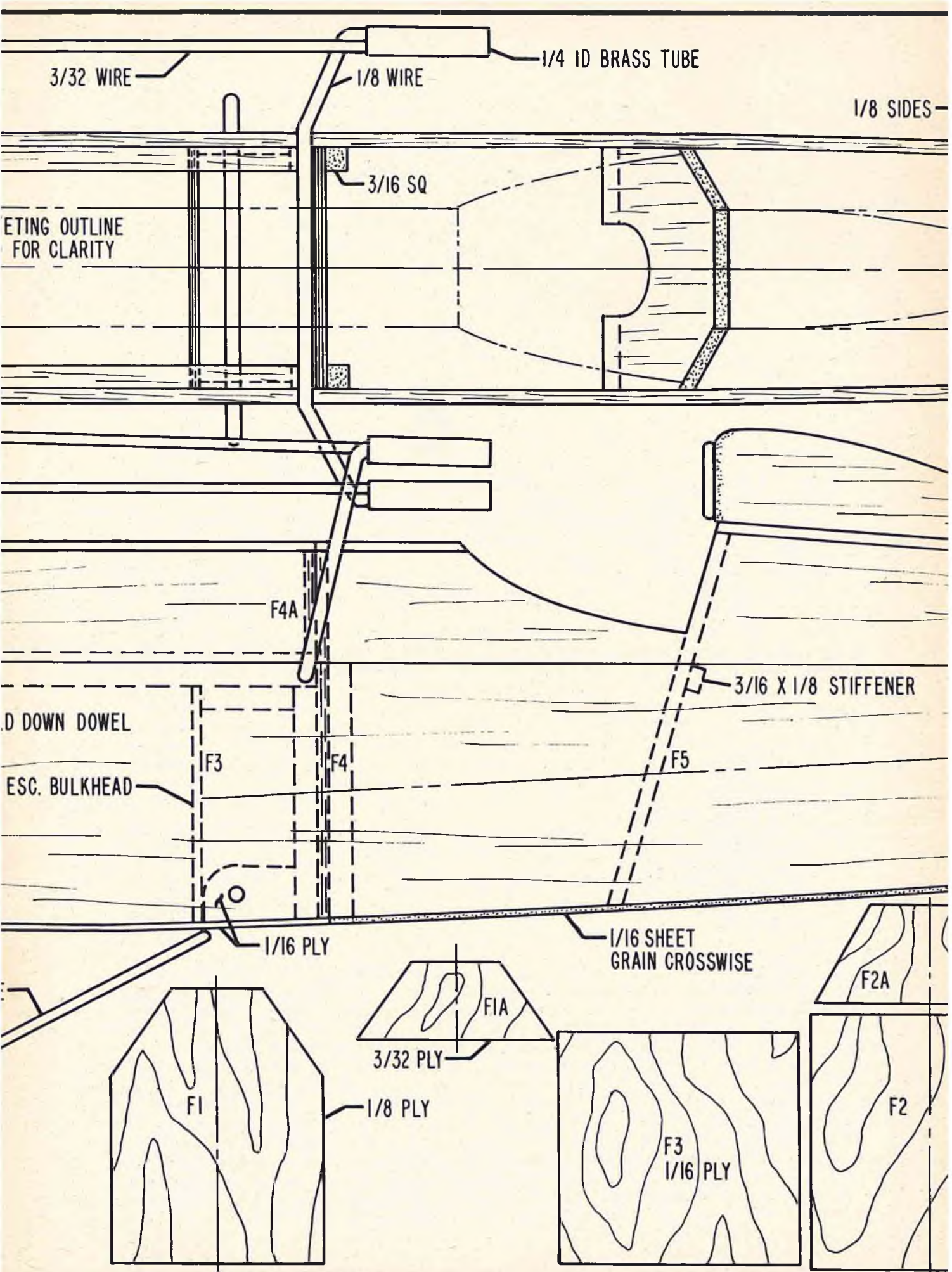



desire. Another method for limited area workshops is to select a  $\frac{3}{4}$ " piece of plywood that is absolutely true, then face it with "bulletin board" stock, laminating the two with a liberal quantity of contact cement.

Secondly, select your working tools with care, then learn to use them well. A #11 X-Acto blade in the slender handle will become your most widely used weapon for attacking balsa wood. As you progress in this hobby you will find uses for a variety of tools — both common and unconventional. In the latter category are emory boards for sanding hard-to-reach places, Q-Tip swabs for wiping glue joints, surgical hemostats for installing small hardware, etc. In the more orthodox section of the tool crib, arm yourself with a supply of rough garnet, or cabinet paper, plus wet or dry stock in the 400 and 600 grades. A razor plane and variety of small sanding blocks are indispensable. Two vice grip pliers plus a small bench vise should be in your repertoire. An inexpensive electric jig saw will save a considerable amount of time and energy — a Burgess BVI unit can be obtained at most hardware stores for \$13 and is entirely adequate. A heavy-duty Dremel Moto-Tool and an inexpensive  $\frac{1}{4}$ " electric drill are not entirely necessary, but certainly helpful. Pick up a selection of drills from the 98c special table at the hardware store if you don't wish to invest in a more expensive set. An assortment of

screwdrivers, pliers, (including long nose and side-cutting), plus a few of X-Acto's modeling accessories will put you in business. Oh, yes — if you're using a building board instead of a metal jig, buy yourself several boxes of good dressmaker pins.

When it comes to adhesives, and covering and finishing materials, select one or two brands and stick with them until you know them thoroughly. At RCM, we use the following: Super Cement and Ambroid for general purpose gluing. Contact cement for laminating fuselage sides and doublers. Hobby-Poxy epoxy glue or Devcon 2-Ton for motor mounts and firewall joints. White glue for plywood to balsa joints. Hastings polyester resin for fibreglassing, or for fibreglass-to-fibreglass or fibreglass-to-metal bonding.

For finishing materials we use Silkspan, or Silron or silk exclusively, applied wet. AeroGloss butyrate is used for initial finishing as well as final color applications.

In choosing your balsa wood for this, or any model, be sure that it is selected for the job it is to perform. **All balsa wood is not alike.** The strength of balsa is directly related to its density. The heavier the wood, the stronger and harder it is. Densities run from five pounds to twenty pounds per cubic foot. Ten to twelve pound balsa is considered medium weight. For all of our prototypes and test models we prefer to use only Sig balsa. This is available in three types — A

grain, B grain, and C grain. The first, or A grain, has long fibers which show up as long grain lines. It is very flexible and bends around curves easily. This grade is used for sheet covering rounded fuselages and wing leading edges, planking fuselages, etc. Since it does warp easily, **don't** use it for sheet balsa wings and tails, flat fuselage sides, or formers.

B grain balsa has shorter grain lines and feels stiffer **across** the sheet. This is a general purpose sheet, used for flat fuselage sides, trailing edges (built up), wing ribs, formers, planking of gradual curves, and wing leading edge sheeting.

C grade balsa has a mottled appearance, is very stiff across the sheet, and splits easily. When used properly, C grade builds the lightest and strongest models. This grade is used for sheet balsa wings and tails, flat fuselage sides (light duty), wing ribs, formers, sheet covered leading edges with slight curves. Do **not** use C grade for curved planking, rounded fuselage sheeting, etc. And if in doubt, send for a Sig Balsa I.D. Chart — it's an excellent reference to hang in your workshop.

**Wing.** Begin construction by securing the  $\frac{3}{8}$ " leading edge in place over the plans. Butt glue the  $\frac{1}{16}$ " x 2" lower leading edge sheeting to the leading edge. Secure the bottom  $\frac{1}{16}$ " x  $\frac{1}{4}$ " trailing edge sheeting in plane. Add the  $\frac{1}{16}$ " x  $\frac{1}{4}$ " lower capstrips. Add the lower center section sheeting. Make two  $\frac{1}{16}$ " plywood rib tem-



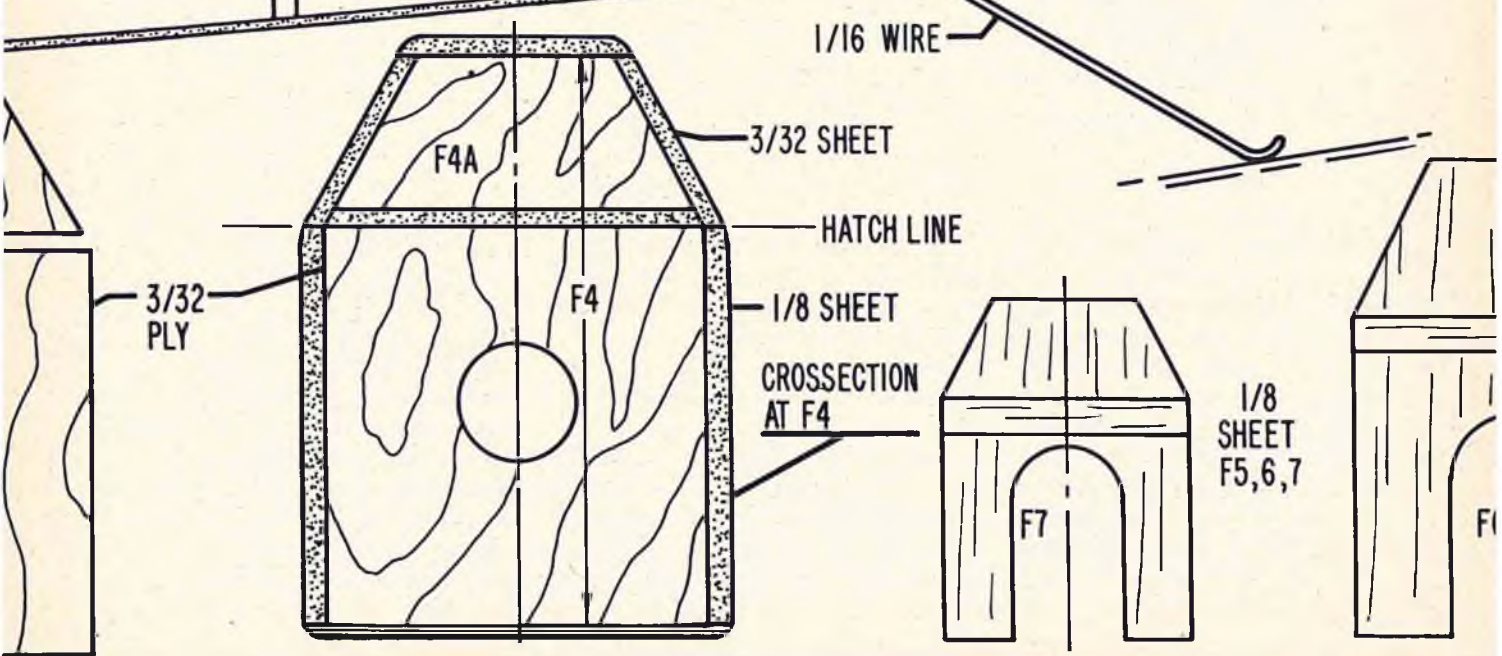
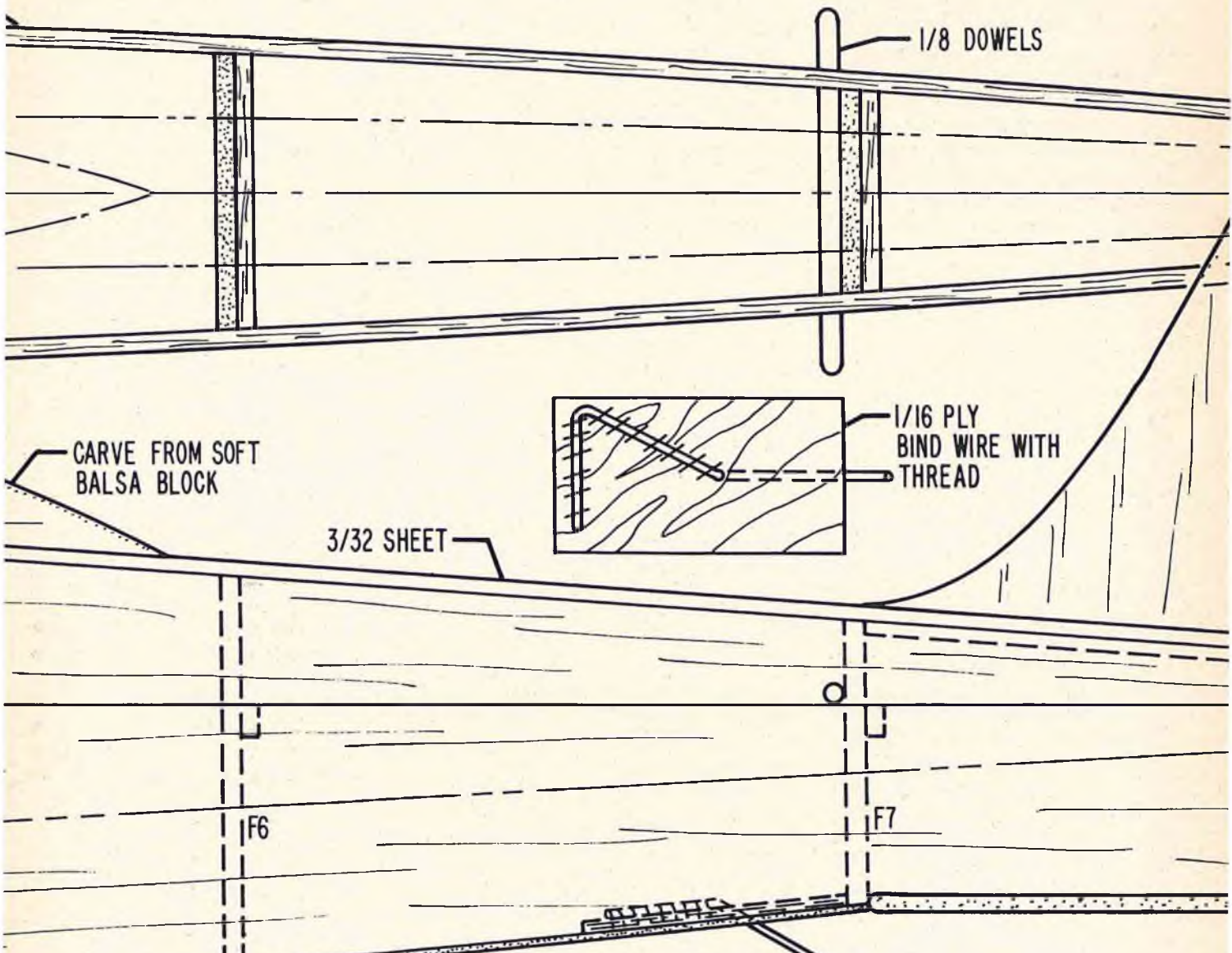

plates and use one for cutting out all 1/16" sheet wing ribs. When this is completed, bundle them together, place a plywood template on each end, then sand until the balsa ribs match the ply rib templates. Glue down the 3/16" square (hard) lower spar, then cement all ribs in place. Add the top spar, top leading and trailing edge sheeting, and capstripping. Repeat this procedure for the opposite wing panel.

When both panels are completed and thoroughly dry, cut two pieces of balsa sheet to the required dihedral height for each wing tip, then tape these temporary sheet pieces to each tip with masking tape. With the wing panels thus blocked up, they may be joined at the center section. Use white glue and allow to dry overnight. When dry, add the center section sheeting, carve the wing tips to shape, then add the tips. Sand the wing thoroughly, working down to 400 wet or dry, used dry. Add a strip of gauze or light Celastic around the center section joint. If using Celastic, simply cut the strip to the desired width and length, dip in butyrate thinner, wrap around the center section, and allow to dry. When the thinner has evaporated, this Celastic reinforcement will be rock hard and ready for sanding.

Brush on three or four coats of dope over all framework, sanding lightly after the second and last coat. Cover the wing with light weight silk, applied wet. This is best accomplished by immersing the silk panel in a pan of water, then laying it out on a turkish towel to absorb most of the excess moisture. Now brush on a strip of dope at the center section, pressing one end of the silk into place at this point, and while holding the remainder of the silk up in your left hand, brush on a strip of dope at the tip of the panel. Stretch the silk over the tip and pull lightly until it is taught spanwise. Now, working from both the leading and trailing edges, and starting at the center section of the wing, brush on dope along both the leading and trailing edges, pulling the silk chordwise and slightly toward the tip, stretching out the remaining wrinkles. When you get to the tip itself, you may have to brush on another coat of dope to loosen the first so that you may pull the silk slightly tighter spanwise to remove the last of the wrinkles.

Repeat this process for the opposite panel. Now, with a razor blade, carefully trim off the excess silk. Dope these edges down, rubbing them

smooth with your finger. Repeat this same covering process for the bottom of the wing. When the damp silk has dried, brush on a coat of dope (thinned 25%) to the entire wing, being careful to remove all excess dope from the brush, and applying the dope with only the tip of the brush with a scrubbing motion. This will prevent the dope from going through the silk and "blobbing" up underneath the surface. Now set the wing aside to dry for another 24 hours.

**Stabilizer.** The stab is cut from 4" wide, 1/8" sheet, with two small pieces added to the trailing edge. Butt glue the latter and allow to dry. Sand the stabilizer to finished shape, and apply three to four coats of dope, again sanding between the second and final coats. Be sure to apply dope to the upper and lower surfaces, alternately, so as to prevent warping. After the final sanding, cover the stab with lightweight colored silk to match the wing. Apply one or two coats of dope and set aside to dry thoroughly.

**Fuselage.** The fuselage is of all-sheet construction. Begin by cutting out the sides from 1/8" stock, then place them together in your hand and sand both until they are exactly the same. **Do not** sand the stabilizer seat to a point where its decalage is altered. Using contact cement, add the doublers to the fuselage sides, making sure you end up with one right and one left side! Add the 3/16" square longerons and uprights. Cut out all balsa and plywood formers, sand to finished shape, then join to the fuselage sides, checking alignment carefully with a triangle. Allow to dry. Add the tail section block, holding the sides together at the tail with masking tape. Check the fuselage length alignment by placing it over a straight line, representing a center line — this is a sure way to make sure that the tail hasn't been pulled more to one side than the other. Add the top rear sheeting, sheet rudder, and headrest. Add the plywood and balsa bottom, planking cross grain. Cut out the removable hatch floor, add the hatch bulkheads, then the side and top sheeting.

Using your vice grips, form the simple 1/8" music wire cabane struts. The cross pieces are cut from 3/32" music wire, then joined to the cabane struts by wrapping with fine copper wire and soldering. Insert the ends of both into a piece of 1/4" O.D. brass tubing. Touch your soldering iron to the tubing to allow the solder at the

wire joints to fuse with the tubing. Join the cabane structure to the plywood bulkheads with clips or J bolts. **Make absolutely sure** your cabane assembly is **exactly** as shown on the plans so that your decalage is the same as the prototype.

Add your escapement, or single channel servo, torque or push rod, batteries and radio gear. A one ounce clunk tank is used for the Babe Bee .049. To use the clunk tank with this engine, carefully remove the firewall mount tank that is installed on the Babe Bee. Drill a hole in the side of the tank to accept the fuel line and run this piece of tubing from the pick-up inside the tank out through the hole. Reinstall the tank and mount to your firewall. The protruding tubing is then connected to the clunk tank behind the firewall.

Wrap your batteries in foam rubber, then place the fuel tank on top of this pack, packing it in place with foam rubber scraps. Add a washer behind the top mounting bolts for downthrust, plus an additional washer behind the left mounting lugs for right thrust. Wrap the receiver in foam and install in the second compartment. Once you are certain that all components can easily be mounted and are readily accessible, remove the gear and engine, and the fuselage is ready for finishing.

The fuselage can be covered with light weight silk or Silkspan — we used silk on the prototype. Brush on several coats of dope, wet sanding with #600 wet or dry (wet) after every two coats, until the silk is filled. Add trim colors as desired (but go easy on the weight), your AMA number (you **do** have one, don't you?), and all remaining details such as gear and stab hold-down dowels, etc.

**Landing Gear.** The landing gear is formed from 3/32" music wire, wrapped with copper wire at the axle, and soldered. Hold a large tipped, **hot** iron under the wrapped joint and apply solder from the top — you don't need large blobs of solder — remember, solder itself has no inherent strength, it's only bonding the wrapped joint together. Add 1 3/4" wheels.

**Finishing:** Brush on several additional coats of thinned clear butyrate dope to the wing and stab, allowing each to dry, and sanding after each two coats. The last two coats may be sprayed on, if desired. Add trim, but keep pigmented dope to a minimum so you won't end up with a streamlined

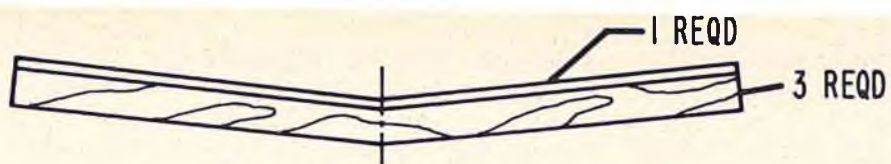

DIHEDRAL BRACE  
3/32 PLY  
2-1/8 DIHEDRAL AT EACH TIP OF WING

MAKE L/G FROM  
3/32 WIRE - FRON

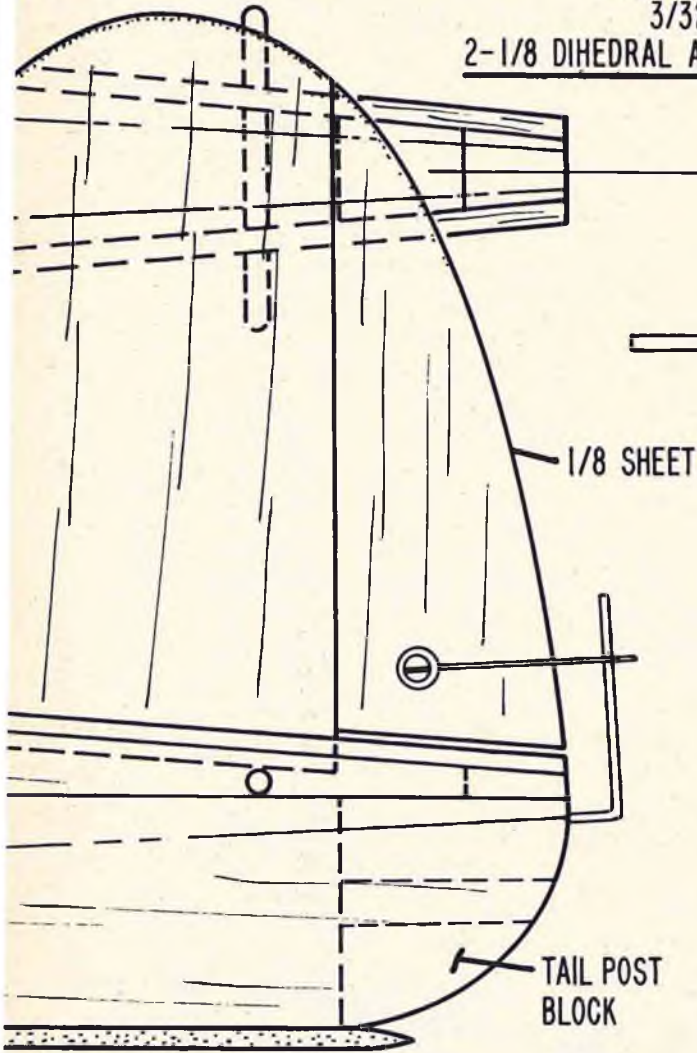

1/16 SHEET RIBS - 16 REQD

3/8 SQ

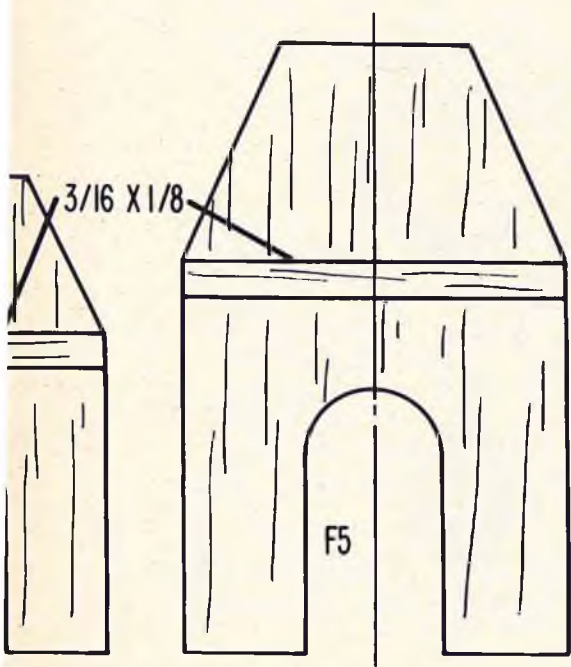
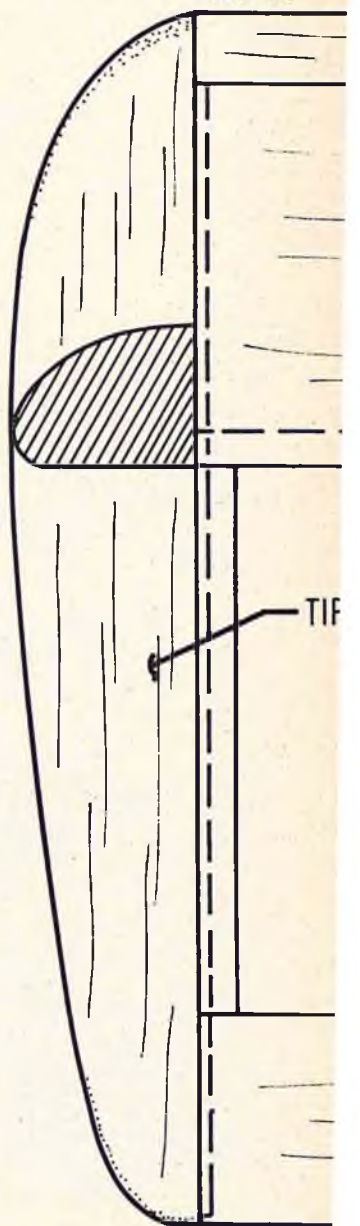
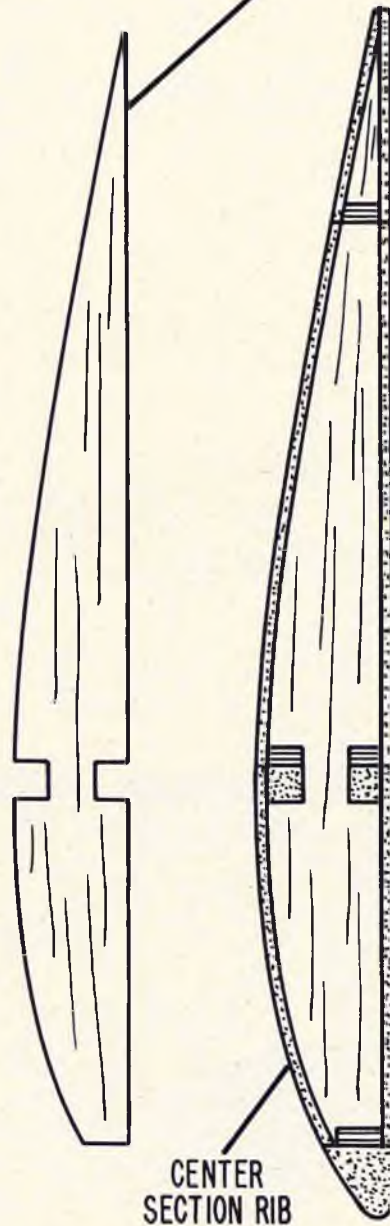

brick! Besides, nothing is prettier than the sun shining through a clear doped, colored silk wing.

**Trim and Flight Tests.** When all construction has been completed, mount the radio gear, engine, etc. and make sure the Lorelei balances exactly as shown. Don't balance the ship at the wingtips with your oversized thumbs — you could be a  $\frac{1}{2}$ " off either way! Balance with two pieces of dowel as close to the center section as possible, shifting components or adding weight as necessary in order to achieve the proper balance.

When this has been completed, check out your radio gear per the manufacturer's instructions. If you are using an escapement, run it through several hundred times to make sure it isn't going to hang up in a position. When all is in readiness, take a tranquilizer, pile the whole thing in the back of the car, and head for a grassy spot for test gliding. Point the nose of

the plane at a spot on the ground about 50-75 feet away, then toss **gently** into the wind. It should glide straight toward the spot without diving into the ground, ballooning, or veering to the left or right.

If it has a tendency to dive, add a  $\frac{1}{32}$ " halsa shim under leading edge of the stab. If, on the other hand, it scallops or balloons, add the shim under the trailing edge. Keep this up until the glide is satisfactory. If the Lorelei veers to the left or right, check first to make sure you launched it **into** the wind, and not at an angle to it! If it still banks left or right, check for warps in the wing and stab. Correct these by holding pressure to the offending area while heating it in front of your car exhaust pipe. If no warps are apparent, bend the torque rod at the tail for a slight rudder deflection in the desired direction. Glide again until this part of the procedure is perfect.

For the first few flights, **don't** fill up the tank. Distance check your radio gear, add fuel, adjust the needle valve, and walk into the wind releasing the Lorelei straight ahead. Let it free flight until it gains some altitude, then apply gentle turns. If your model turns left under power, you need another washer of right thrust. If it turns right under power, you will have to remove some right thrust. If it climbs, or scallops under power, add more downthrust — a little at a time. If it will not gain altitude at all, you have too much downthrust.

When all is adjusted, you will have a model that will be a complete pleasure to fly — and one that can fly from limited areas over rough terrain.

That's the Lorelei — a slow flying sport model with a little bit of appeal for just about everybody, and one that is reminiscent of the full-scale home builts of the pre-war era.

**PLANS FOR THE LORELEI HAVE BEEN PRESENTED FULL SIZE FOR YOUR CONVENIENCE. REMOVE PLAN PAGES 22, 23, 25, 27, 29 AND 49 FROM THE MAGAZINE AND JOIN WHERE SHOWN WITH CELLOPHANE TAPE.**



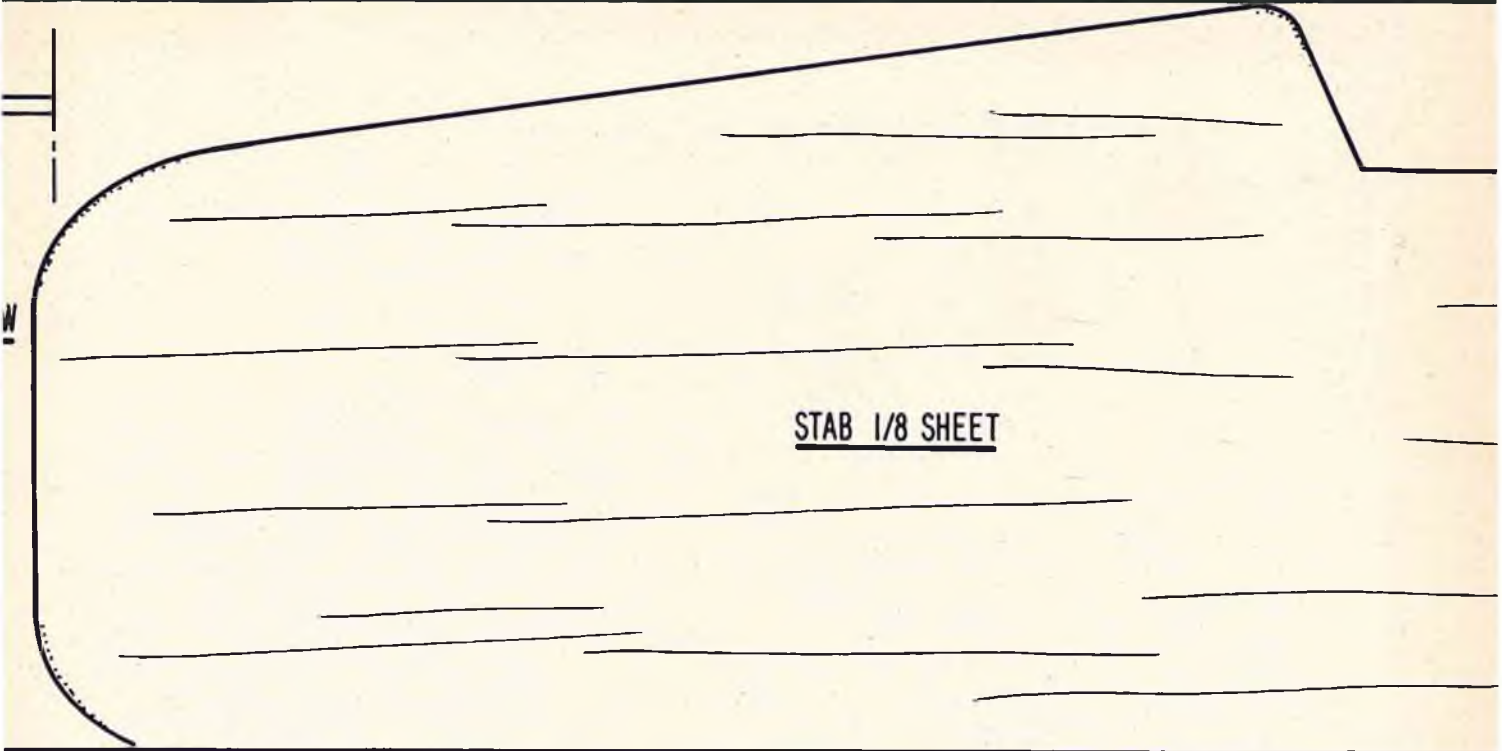

STAB 1/8 SHEET

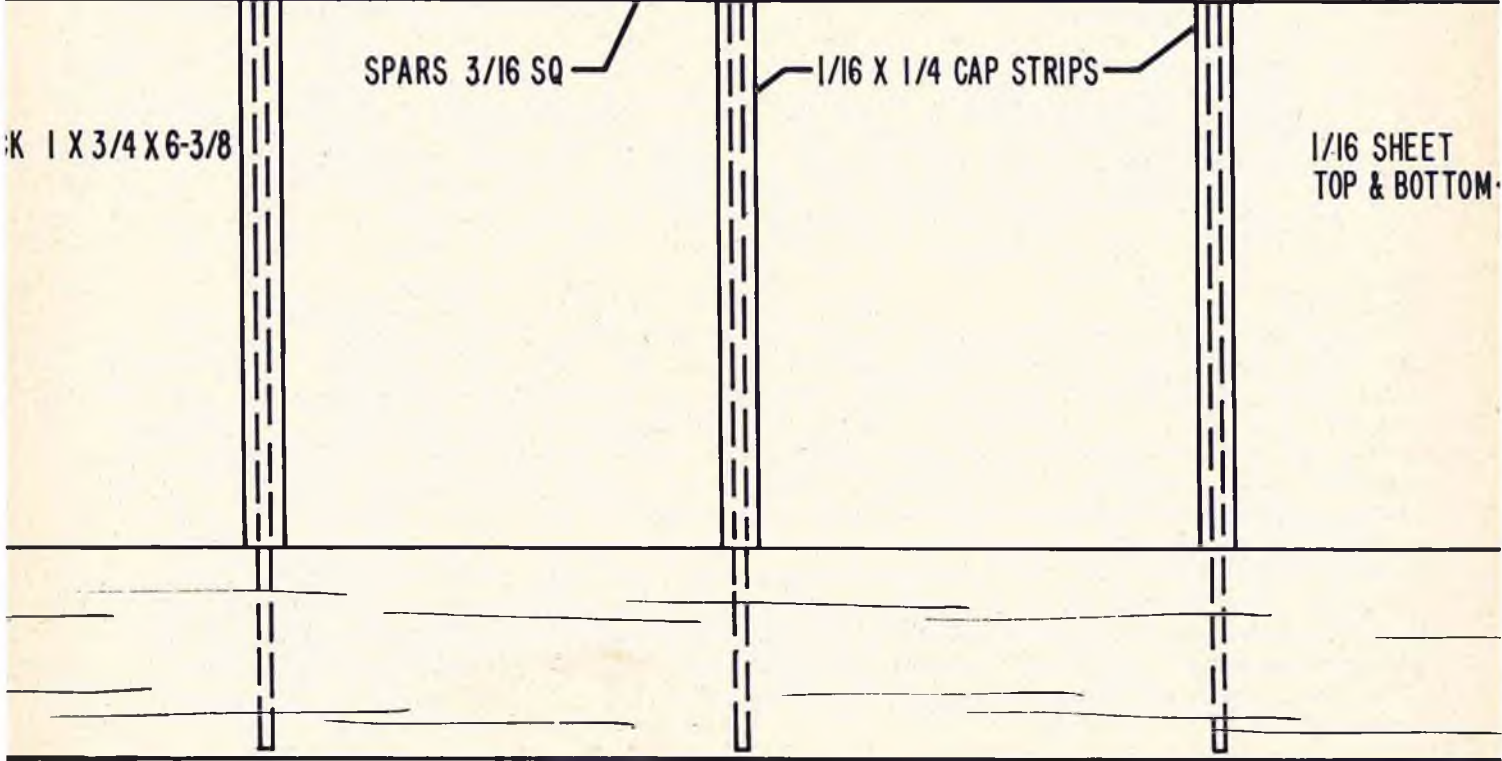
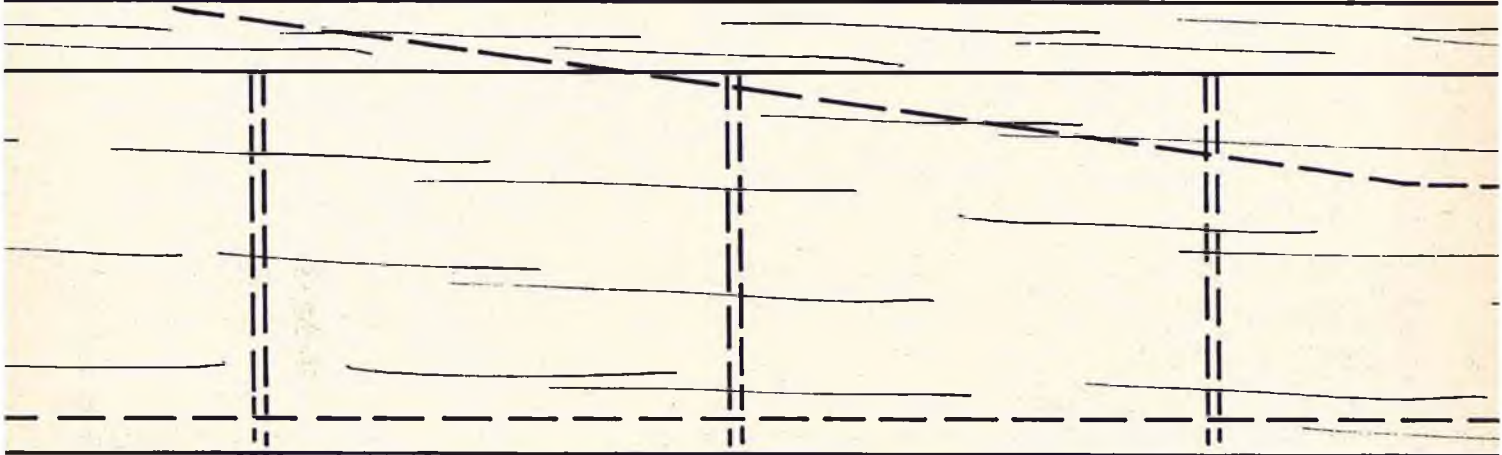

SPARS 3/16 SQ

1/16 X 1/4 CAP STRIPS

W 1 X 3/4 X 6-3/8

1/16 SHEET  
TOP & BOTTOM

# BONNER DIGIMITE



***Ergonomics . . . and a \$615 price tag. RCM Editors conclude two months of extensive field tests on the Bonner Digimite Proportional System. Here's what you'll get for your money . . .***

Ergonomics is a space-age word coined by product research engineers to define "human reaction to a given product." And, apparently, the product research department at Bonner Specialties underestimated the ergonomics of the new Bonner Digimite Proportional System, as evidenced by a back order letter to distributors on January 26, only a few short weeks' after the initial announcement that the Digimite was available for delivery. To quote a portion of that letter — "We want you to know that we have done everything we can to speed and increase production. We have nearly doubled our personnel, we are doing all possible to keep the flow of components coming into our plant, we are working evenings, we are streamlining methods; in short, we are trying our best to fill everyone's order. The overwhelming response is gratifying and we are doing our best to deploy our responsibility to this response."

The phenomenal initial success of the Bonner Digimite is creating a

wholly different atmosphere in the radio control industry. While many competitive manufacturers are attempting to reduce their price below the \$400 mark by selling direct, the Digimite has been made available through the conventional chain of distributor-dealers with a price tag to the consumer of \$615, sans any financing program. While these same manufacturers are trying to render their product more saleable by providing as many options as possible, the Digimite is available in one standard model only. Perhaps these manufacturers have overlooked the one prime factor taken into consideration by the Bonner product research team — that proportional control is not just an expensive toy for the contest flier, but must be a repeatable production item designed for the average RC'er who wants to participate in this new sense of flying freedom and versatility which brings him the utmost in flying pleasure — proportional control.

RCM's test and evaluation studies

of this new system began with a call from Cliff Weirick to pick up a production model of the Digimite. Staff members Chuck Waas and Frank Justin traveled to Bonner's Culver City, California plant and were asked to take a system directly from the shipping department from a lot scheduled for immediate shipment to dealers and distributors. These were packed in a form-fitting styrofoam packing case which offers perfect protection during shipment and should be appreciated by the new owner. The unit selected by RCM was on 27.145 mc.

## **General Description**

The Digimite system operates on a digital principle. The transmitter continually sends frames of 16 pulses, the spacing of these pulses providing eight pieces of control information. The manufacturer claims that this type of system is inherently more stable and accurate than other types, with no discernible neutral drift, and allowing the control surfaces to follow the stick with exacting accuracy. The super-



Top, L to R: Frank Justin checks out Digimite servo at Bonner Specialties; Chuck Waas and 'Candy' test ship; a portion of the assembly line at the Bonner plant; one of the steps in the Digimite production. Bottom, L to R: Unique Digimite stick assembly, photographed from inside rear of transmitter. Note mechanical trim feature; Digimite two-deck receiver; servo with half-shell removed — note ball bearings at top; Justin at final inspection; Digimite systems awaiting testing.

heterodyne receiver utilizes three intermediate frequency stages (IF). The detected pulses from the superhet circuit are fed to a logic circuit which examines each digital pulse frame for completeness. In the event of missed pulses, or interference, this circuit rejects the frame of information. Further, if no frames are acceptable for one-quarter second, the receiver and servo system go to fail-safe until valid information is received. During this period, control surfaces are placed very near neutral with the throttle in idle position.

The logic circuit itself is capable of separating the 16 pulses of a frame into 8 pairs — presenting eight pieces of information. These "pulse pairs" are sent to the servos. Each servo has an electronic module which measures the distance between pulses fed into it by the receiver. You could, in effect, consider this module a switch. If the servo mechanical output does not coincide with the stick position of the transmitter, this electronic module, or

switch, applies full voltage to the servo motor until this error is canceled. This, of course, is not in proportion to the error. Air loads or linkage friction do not degrade the servo loop performance, as this is a relative factor and not to be considered as condemning an analog-type system. Even though an analog system might not "see" full voltage on an error signal, the voltage it does see is enough to fly model airplanes, as witnessed by prior RCM tests on two analog systems.

**Transmitter.** The Digimite transmitter is quite unique in many respects and evidences a considerable amount of mechanical engineering consideration. The clever ball and socket stick assemblies keeps dust and dirt out of the transmitter and provides mechanical trim whereas most digital systems use separate potentiometers for trim functions. A two stick arrangement, the left hand stick provides rudder and throttle, while the right hand stick provides aileron and elevator. It is the feeling of the manufacturer that pro-

portional pilots, experienced reed fliers, and beginners quickly adapt to this two stick arrangement, and that experienced reed fliers make the transition much more rapidly when they no longer find the elevator in the left thumb position. This stick configuration permits manipulating all prime controls simultaneously without removing hands or thumbs from any of the controls. In addition, when any of the four auxiliary controls, located on a panel in the upper left portion of the transmitter, are utilized, only the left hand is required to move the levers, while the right hand still handles the prime aerodynamic controls. Since there is a controversy over the easiest stick configuration to fly, most manufacturers provide an interchangeable stick assembly. Bonner does not. Therefore, it was a note of interest to find that both RCM test pilots, both of whom are good reed fliers and neither of whom are experienced pro-

*(Continued on Page 52)*

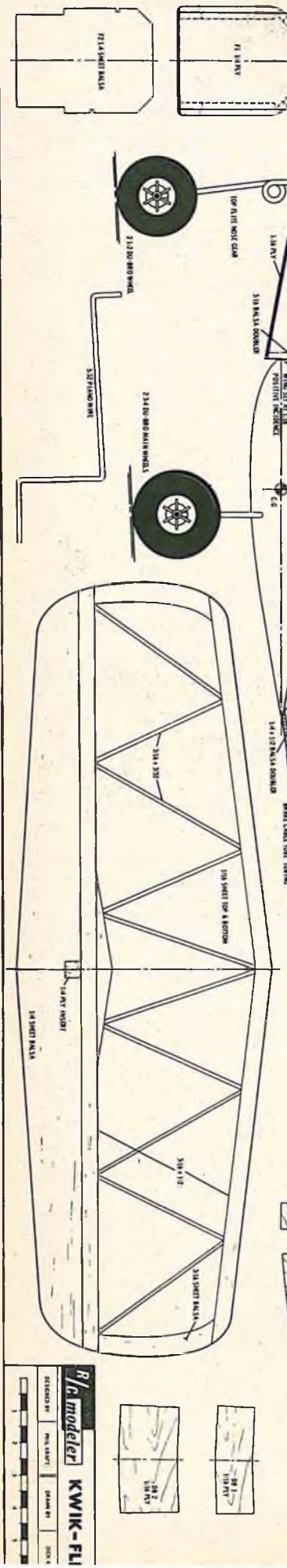
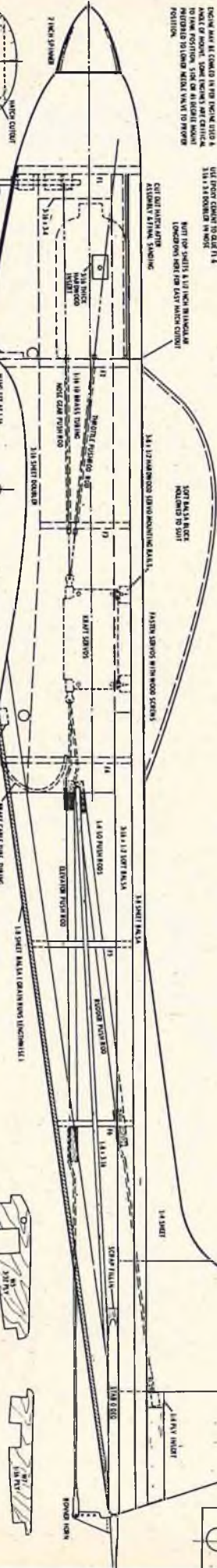
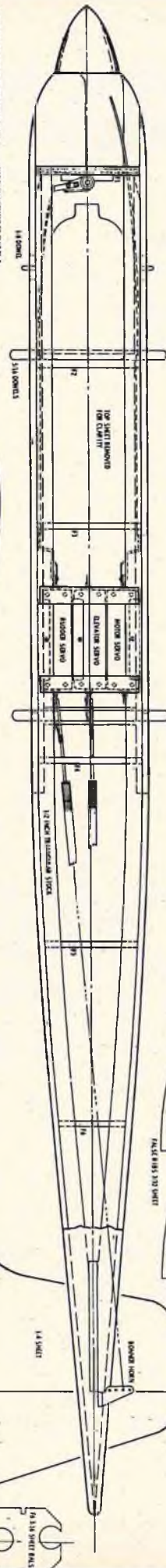
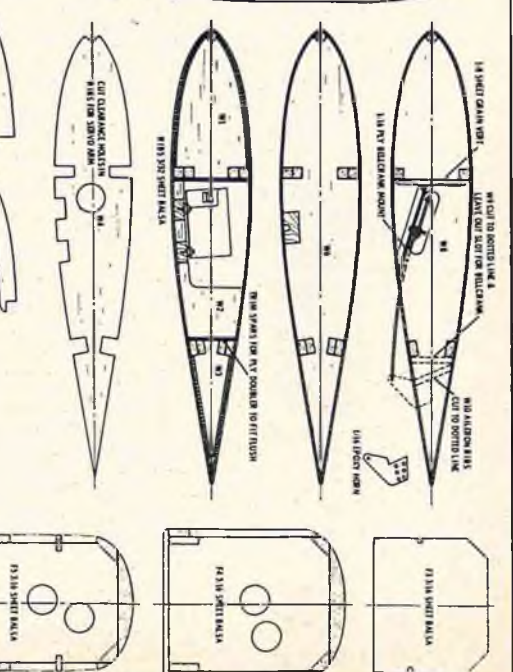
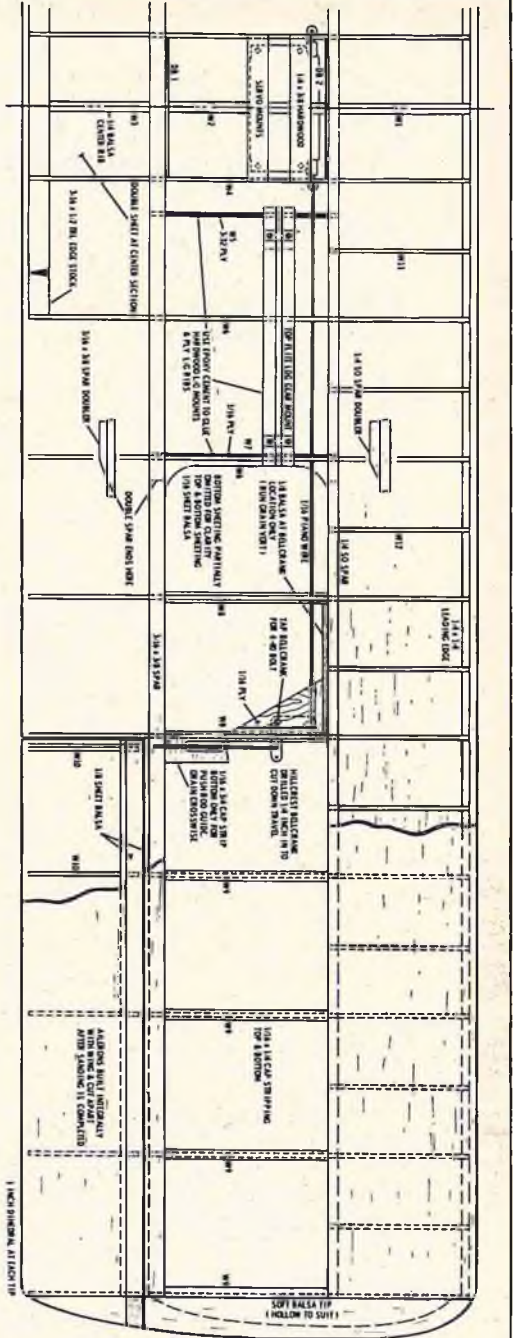

ENGINE MAY BE COMED IN THE ENGINE CRIB A  
 POINT OF MOUNT, SOME HAVING ONE CRIB  
 POSITIONED TO ALLOW FUEL TO FLOW  
 POSITION.

USE FRONT COUPLER TO QUOTE IT'S  
 3/16\"/>

NOTIFY US SHEETS & 1/16\"/>
 POSITION FOR EAST WING COUPLER  
 ASSEMBLY AT THIS STATION.

SOFT BALANCE  
 REQUIRES TO SOFT  
 1/16\"/>

1/2\"/>
 1/2\"/>

1/4\"/>

1/4\"/>

1/4\"/>

1/4\"/>

1/4\"/>

1/4\"/>

1/4\"/>

1/4\"/>

1/4\"/>

1/4\"/>

1/4\"/>

**R/C Modeler** KWIK-FLI  
 CHECKED BY: [ ]  
 FILED BY: [ ]  
 DATE: [ ]  
 1/4\"/>



# THE BABCOCK '27'

*Pre-wired and cabled, ready to install, a complete single channel system with rather unique engineering design. At a time when the single channel servo is the popular contender, this offering introduces a new concept in escapements. RCM wondered why . . .*

At a time when most single channel fliers are turning to imported rudder and throttle servos, it came as something of a surprise that a large national manufacturer would introduce a single channel system that incorporates escapements rather than following the current trend toward motorized actuators. Our amazement was further compounded when this was advertised as a "complete, pre-tested system."

Upon obtaining a Babcock '27' system for test and evaluation, we were surprised to find that this is a "system" — that is to say, the receiver, compound escapement, throttle escapement, battery clip and switch panel, are all completely wired and cabled, ready to install without benefit of soldering iron. In addition, all '27'

systems are pre-tested as a system at the factory prior to shipment. This, however, was not the only innovation. The transmitter employs a stick control which is, in effect, an electro-mechanical collector ring that eliminates push-button single channel flying. Although somewhat reminiscent of the older Babcock 'Digitran' system, the newer '27' bears little resemblance, either mechanically or electronically, to its earlier predecessor. Another interesting feature is the fact that the escapement arms are mounted and soldered in place with the torque rods already in position and stubbed out. A clever "universal joint" is supplied for connection to the torque rods in the airplane. Centering springs are in place on the escapement, factory installed

and adjusted, to eliminate control surface centering springs on smaller aircraft.

Pending further evaluation, it appeared that the manufacturer's objective was to provide a single channel system that would provide a maximum amount of control for a minimum expenditure, while eliminating most of the tinkering normally associated with escapement systems, and even further compounded by multiple-function escapement set-ups.

## General Description

**Transmitter.** Utilizing digital techniques, the '27' transmitter contains a crystal oscillator, series modulator, audio multi-vibrator, stick controlled time base, and "quick-blip" discharge circuit for motor control. Transmitter coding is accomplished electronically — short, crisp keying automatically accomplished when the control stick is moved to any one of the four positions, e.g. right, left, up, or down. The motor control is a pushbutton switch, which, when depressed, advances or retards the throttle. The transmitter itself is contained in a bronze hammertone case. Antenna is a telescoping, collapsible chrome plated unit. On the transmitter face panel is an on-off switch, plus tone and timing adjustments. Power supply is four 9-volt transistor batteries.

**Receiver.** The '27' receiver consists of a super-regenerative detector followed by two cascaded stages of frequency selective audio amplification (6000 cycles), a driver transistor,

*(Continued on Page 48)*



Above: Complete '27' system as received and ready to install.

Left: Inside the transmitter, minus the four 9-volt transistor batteries.

Below: The '27' receiver — a super-regen receiver with a purpose.



# KITS and PIECES

*Tips and hints on the new kits and accessories . . .*

*This month, building the Skylane by Carl Goldberg.*

This month we "take off" with a new column, dedicated primarily to the sport, or fun flier, and to the newcomer to RC. We will examine and discuss many of the new kits, equipment, and gadgets offered to the RC'er. Our "reviews" will attempt to clarify, rather than criticize. It is hoped that these supplemental notes will be of benefit to the newer modeler. In time, it is our goal to cover the entire range of ships and equipment, from Rudder Only through Multi-Proportional.

in their respective sheets, and a little extra time taken to cut them will invariably produce a more accurate part without splitting. All pieces had an embossed part number, although many of these were hard to see or identify. All parts were removed from the sheets and identified, being certain that no small part removed remained with the "scrap."

I began construction with the fuselage (Ed's note: I don't like wings either, Bernie!) making all of the sub-assemblies as indicated. Contact ce-



To begin, we are building the new semi-scale Cessna Skylane by Carl Goldberg Models. This ship is a 1/2A, rudder only, with a span of 42 inches, and an area of 244 square inches. The wing has a Clark Y airfoil (flat bottom — high lift) with excellent weight carrying capabilities.

The kit under construction was a production unit, and should therefore, be typical of any purchased at local hobby shops. The die-cut sheets were cleanly cut and required only a minimum effort to remove the parts. Small uncut tabs are used to hold the parts

ment was used for all doublers, allowing work to progress rapidly. I have been using contact cement for this purpose for several years, and have found no particular drawbacks.

At Step #3 on the plans, it was noted that the strut slots were not cut all the way through the fuselage sides. It was decided that this should be accomplished at this point, since it would be much more difficult after the sides were assembled. The sides were then assembled to the formers,

*(Continued on Page 59)*

## *Citizen-Ship*

**COMPLETE**  
Analog Proportional System  
For UNDER \$250.00



- ★ Superheterodyne
- ★ Fail Safe
- ★ All Transistorized
- ★ Dual Simultaneous plus trimmable motor
- ★ The Intermediate Proportional—Ideal for Class I, Class II & Pylon AMA Flying
- ★ Tone modulated for maximum noise rejection
- ★ Reliability through simplicity of design
- ★ Size permits installation in practically any R/C Kit.

Suggested List Price .....\$249.95

Available in 26.995, 27.045, 27.095, 27.145,  
27.195 and 27.255 mc.

### CONSISTS OF:

**APT Transmitter**—including externally loaded antenna. Purchased separately—Suggested List Price .....\$89.95

**APR Receiver**—Note Size: 1-11/16" X 1 3/4" X 2-1/16". Weighs 3 3/4 ounces. Purchased Separately—Suggested List Price...\$74.95

**2 APC Proportional Servos**—Closed loop feedback. All nylon drive train for quiet efficient operation, NOTE SIZE: 2 5/8" X 1-9/16" X 1". Weighs 2 3/4 ounces each. Purchased separately — Suggested List Price .....\$34.95 each

(A third APC Servo may be purchased which can be paralleled with the rudder servo from a single output to obtain CAR.)

**1 APM Trimmable Servo**—Mechanically the same as APC above. Purchased separately—Suggested List Price.....\$25.95

**1 Printed Circuit Wiring Board**—Complete with switch and 5 plugs and sockets. Board circuit automatically does all inter-connecting. Purchased separately — Suggested List Price .....\$12.95

Send for catalog of **CITIZEN-SHIP'S**  
Complete Line.

## *Citizen-Ship*

**RADIO CORPORATION**

810 East 64th Street, Indianapolis, Ind. 46220

# NATIONAL ASSOCIATION OF RADIO CONTROL CLUBS

ADDRESS: N.A.R.C.C., c/o R/C MODELER MAGAZINE • P.O. BOX 487, SIERRA MADRE, CALIFORNIA

This month marks the birth of the National Association of Radio Control Clubs — a service organization founded by R/C Modeler Magazine in the interests of, and at the request of, radio control clubs throughout the United States. It is the purpose of the N.A.R.C.C. to promote and encourage active club membership; to promote club and inter-club activities; and to provide a closer working relationship between local RC organizations throughout the country. In addition, the N.A.R.C.C. will serve as a communications center for the publishing of news releases of general interest concerning club activities; the listing, promotion, and coverage of local and regional club-sponsored contests; and serve as a referral service to individual RC'ers interested in membership in a radio control club in their geographical area. A complete listing of all member clubs will be periodically published. The N.A.R.C.C. will also serve as a representative for the radio control clubs, and regional councils of clubs, in any matters where specifically requested by the majority of member clubs, and in the interests of furthering the aims and objectives of the sport of radio control.

There are no dues or fees for membership in the N.A.R.C.C. All radio control clubs are simply requested to complete the membership application form, along with all required information concerning their particular organization, and to place the N.A.R.C.C. on their mailing list for news releases, club papers, etc. A membership certificate will be forwarded to member clubs as soon as they are available.

## Pittsburgh ARCS Plan Air Show For '65

Pittsburgh, Pa. The Greater Pittsburgh ARCS are planning a series of programs for 1965 that we feel will not only stimulate new interest and teamwork among their own members, but provide an incentive for RC clubs throughout the country. This will be accomplished by the proposed replacement of their Annual Contest with an Air Show. This is being done due to several factors — among them the fact that many club members do not participate in formal pattern event contests due to the fact that they are not primarily contest fliers. In addition, novelty events at intermission time have drawn a greater degree of spectator interest, and therefore have served to create a greater general public interest in our form of model aviation.

Although complete plans have not been finalized for the event, it is anticipated that the originality and ingenuity of individual or team entries will produce a wide interest in the Air Show. Events under consideration are glider tow, or pickup; formation flying with scale aircraft; aerial combat, etc. This type of program will not only encourage teamwork coupled with originality, but create a widespread interest in radio control among the spectators, while greatly enhancing the individual entrant's ability as a radio control builder and flier. We are looking forward to this first Air Show as an event that may well set a precedent in 1965 and stimulate new interest in the waning competitive portion of R/C.

## Kraft, White, Pullen Win at Buckeye

Phoenix, Arizona. The 1965 Southwest Regionals R/C Meet presented some of the stiffest competition we have witnessed to date. The top two positions in Class III were continuously juggled back and forth as Phil Kraft and Ted White maneuvered for top honors. Kraft, flying his familiar Kwik-Fli design (RCM plan) and Kraft Proportional System finally nudged out the persistent White, the latter capturing second with an F&M Proportional System. In third place was Jerry Pullen with a Stormer and Kraft Proportional. Willie Smith and Cliff Weirick were fourth and fifth, respectively. The point spread between first and second place was a narrow six-point margin!

## Valley Flyers Participate In Radar Tracking Demo With Local Electronics Firm

Canoga Park, California. From the Valley Flyers R/C Club a few interesting notes by Jim Oddino on a radar tracking demonstration by Canoga Electronics, a Southern California industrial electronics firm. The latter organization felt that a dramatic method of demonstrating their missile and satellite tracking antennas would be to track a radio controlled model for potential customers. To say that the results of this experiment were impressive would be putting it mildly!

The tracking system antenna was designed to lock on to the telemetry transmitter of the missile or satellite being tracked. It is constructed of an array of dipoles on a reflector approximately eight feet wide by twelve feet high, and moved on a pedestal, positioned with electric motor servos. Two racks of electronic gear complete the system. For this demonstration, Canoga Electronics had mounted a closed circuit TV camera in the center of the antenna and a movie camera in one corner of the rig. A small transmitter on

220 mc. had been built up, the latter being about half the size of a package of cigarettes. Frank Capan and Zel Ritchie built the models and handled the piloting end of the demonstration.

The antenna system described tracked the model all over the sky, including some overhead passes that must have resulted in angular rates of 50 or 60 degrees per second. At all times the model stayed right in the center of the TV monitor. Only one potential problem developed when Capan and Ritchie flew in a circle around the antenna, resulting in the antenna winding up around its own cable! A quick call on the walkie-talkie to the pilot a quarter mile away, saved the day — he simply reversed his course and unwound the cable!

As the spectators and modelers left, the executives of the electronic firm were busily dreaming up all kinds of schemes for using radio controlled model aircraft — it seems these "toys" have almost a universal appeal once the public understands their functions and capabilities.

## MECO / RC Slates Invitational — Lists Novice Handicap

Feasterville, Pa. Three "Fly-For-Fun" days and a two-day invitational meet have been scheduled for 1965 by the newly formed Mid-Eastern Council of Radio Control Clubs. Consisting, at present, of the Bucks County RC Club, Philadelphia R/C Inc., Lehigh Valley R/C Society Inc., Glenside Air Scout R/C, and Valley Forge Signal Seekers, the MECO/RC consists of 184 licensed AMA members.

During the coming year, the Council will use a new method of scoring inter club, AMA pattern meets. Two sets of scores per flier will be kept with handicaps given to induce new and inexperienced fliers to attend and participate, in these meets. The winners under the handicap system will be competing for MECO/RC trophies only. From the un-handicapped portion of the programs, one flier will be selected from either Class I, II, or III, and financially assisted by the Council to attend the 1966 Nationals.

## Meroke /RC Club Roster Lists Fifty



Nassau, L.I. The Meroke RC Club Inc. was organized over two years ago by RC fliers in Nassau County on Long Island, and has been an AMA Chartered club since that time. The club was incorporated a year and a half ago and carries its own liability insurance in addition to existing AMA insurance.

Growing from an original charter membership of twenty to a current roster of fifty, the Meroke group hold club contests frequently during the year, with a joint picnic-contest held each year with a neighboring club.

Through the efforts of this group and another RC club, Mitchell AFB is used as their flying site. Currently, negotiations are being concluded with County officials for an improved, permanent flying site for radio control use.

## 3rd Annual Wright Bros. Memorial To Be Held At Dayton, June 19-20

Dayton, Ohio. The Third Annual Wright Brothers Memorial Radio Control Championships will be held at Wright Patterson AFB, Dayton, Ohio, on June 19-20, 1965. This will be an AMA sanctioned Triple-A contest with the following events: Class I (Jr., Sr., Open), Class II (Jr., Sr., Open), Class III (Novice, Expert), AMA Pylon, AMA Scale (planes will not have to fly to compete), and Open Pylon. In addition, specialty events will include Limbo, Spin, and Combat. Contest site will be Area B of Wright Patterson AFB on Route #444, eastern Dayton.

Last year's Wright Brothers event was noted for the high quality of flying, with the contest apparently serving as a warm-up session of Nationals Champion Cliff Weirick, who took first place at both events. In 1964, a total of six portable TV's were among the many prizes awarded from 1st through 7th place.

The 1965 version of this annual event should easily be remembered as one of the top RC contests in the Country. Four flight circles will again be used, with all contestants restricted to the use of superhet, or six meter equipment, with the exception of the AMA Pylon Event. Don Laughead will again be the hard-working Contest Director.

## Bob Green Awarded Turner Sportsmanship Trophy

Denver, Colorado. From Capt. Frank H. Mock, USAF, President of the Mile Hi R/C Club comes word of that club's presentation of their first Robert M. Turner Memorial Award for Sportsmanship to Bob Green at their January RC banquet. This perpetual award was made to Bob for his outstanding sportsmanship and an ability to always "make" time for his fellow modelers. It is largely due to the efforts of this one individual that a great percentage of RC modelers in and around the Denver area are actively participating in radio control today.

Bob Green — recipient of the Memorial Award for Sportsmanship — an RC'er's RC'er!



## N.A.R.C.C. CONTEST CALENDAR

Submit all contest data 60 days  
prior to date of contest

### APRIL

3-4 Alexandria R/C Contest. Class I, II, III. (AA) Pollock Airport, Alexandria, La. Contact: F. Duvall, Rt. 2, 446 S. Pineville, Louisiana.

### MAY

15-16 Rocket City Fifth Annual R/C Meet. Class I, II, III, Unlimited Pylon. (AA) Club Field, Highway 772 East. Contact: C. Scholefield, 2709 Briarwood Drive, S.E., Huntsville, Alabama.

22-24 Yorkton R/C Club 3rd Annual Fly-For-Fun. No pattern, Novelty Events only. Yorkton, Saskatchewan. Contact: Brent Reusch, 221 Roslyn Ave., Yorkton, Sask.

29-30 ARCS Novelty Contest for New York area RC clubs. Contact: Bill Kenyon Sr., Box 63, Pompey, N.Y.

### JUNE

5-6 Lincoln Sky Knights 1965 R/C Contest. Class I, II, III, Single Channel Only, Scale, Open Pylon. Contact: C. Cartagena, 1909 N. 58th St., Lincoln, Nebraska.

5-6 Detroit R/C Contest for Class I, III, Scale. 18 Mile and Mound Road. Contact: T. Brett, 18864 Millar, Mt. Clemens, Michigan. (AA)

5-6 Tri-Valley R/C Club Multi Contest. Class III, Pylon. Tri-Valley Field. Contact: J. Hoffer, P.O. Box 2173, South Bend, Indiana. (AA)

11-13 11th Annual RC/NC Invitational Meet. Class I, II, III, Pylon, Scale. Asheville - Hendersonville Airport. Contact: W. Bunting, 311 S. Elam Ave., Greensboro, N.C.

12-13 Mid Eastern Council of R/C Clubs Invitational. Sky Manor Airport, Trenton, N.J. Contact: K. E. Kane, P.O. Box 352, Feasterville, Penn.

19-20 Third Annual Wright Bros. Memorial R/C Championships. Wright Patterson AFB, Dayton, Ohio. (AAA) Class I, II, III, Pylon, Open Pylon, Scale, Limbo, Spin, Combat. Contact: Don Laughead, c/o Hobby Kollege Inc., 2320 E. Dorothy Lane, Dayton, Ohio.

19-20 Forest City Flyers 12th Annual International R/C Contest. Expert and Novice Multi only. Forest City Flyers Model Flying Field, #22 Highway, London, Ontario, Canada. Contact: Dick Hancock, 134 Laurentian Dr., London, Ontario, Canada.

### JULY

11 R/C Air Show Contest for Class I, II, III, Scale, Pylon. Line Material Field. Contact: E. Evans, Box 87, Richburg, N.Y.

26- Aug 1 1965 National Model Airplane Championships, Willow Grove NAS, Willow Grove, Pa. Contact: Academy of Model Aeronautics, 1025 Connecticut Ave., Washington, D.C.

### AUGUST

14-15 ARCS 15th Annual Hobo Meet. Open to all RC'ers. Contact: William Kenyon Sr., Box 63, Pompey, N.Y.

National Association of Radio Control Clubs  
c/o R/C MODELER MAGAZINE  
P.O. Box 487 • Sierra Madre, Calif.

### MEMBERSHIP APPLICATION

1965

### CHARTER MEMBER

Club Name _____	No. of members _____
Secretary's Name _____	AMA Charter Yes <input type="checkbox"/> No <input type="checkbox"/>
Address _____	Do you have a regular flying site
City _____ State _____	<input type="checkbox"/> Yes <input type="checkbox"/> No <input type="checkbox"/>
Approximate percentage of members flying multi: _____%	
Approximate percentage of members flying single channel: _____%	
Time and place of regular meetings _____	

# SHOP and FIELD

## VIBRATION PROBLEM?

Many of us know how it feels to be ready to fly to find that vibration is getting to the reed or relays. The vibration, of course, is caused by the engine, but is not always the fault of an unbalanced prop. Three things should be considered when vibration problems show up:

The first consideration requires making sure you have enough foam around the receiver to absorb vibrations while making sure the receiver is just snug. You should be able to install the receiver easily without force, while removing it should not require the use of a crowbar.

Secondly, the lengthwise dimension of the reed or relay armature should not be parallel to the bulkheads of the fuselage. This is because engine vibration is mainly up and down and sidewise in relation to plane. Since fore-aft vibration is at a minimum, you will have less trouble if reeds or relays are mounted so that the normal movement of the armature is in a fore-aft direction.

The third consideration is usually not given much thought and is probably relatively rare in number of occurrences. In most multi installations, nylon control horns would eliminate noise generated by vibrating linkages. However, what about your throttle control rod? Does it go through a brass tube, or make a loose connection at the carburetor? Use of nylon to prevent wire linkages from rubbing and causing noise may be worth thinking about since static noise can drive reeds, thus causing erratic response, or causing of the relay to chatter with a resultant loss of control.

An added benefit of properly packing and positioning the receiver is that component fatigue and failure, caused by vibration (such as capacitors being literally shaken off the PC board) is kept to an absolute minimum. It is also worth remembering that transistors are relatively rugged, but excessive vibration certainly doesn't do them any good. So, take care of your equipment and enjoy more of those "soft landings."

## BATTERY PACKS OR BOXES?

One of the most prevalent problems in equipment failure can be traced to battery holders or boxes. There are some that provide a "snap-in" contact for the batteries, wherein pressure on the contacts depends upon the spring tension of the holder. These can lose that tension in a rough landing and will have to be re-bent. Other types have little push springs at each contact end to give pressure against the battery.

Usually a box is made up to suit the battery requirement. Caution should be exercised in making sure the springs and contacts work freely before installing the batteries. Soldering leads sometimes provides excess heat that melts the plastic

material around the contact, in turn causing it to bind.

Another type holder, designed for four penlight size batteries, has a square removable top with a bolt going down through the center, engaging a thread in the bottom. You can tighten the bolt and feel the positive contact on all cells, providing a vibrationless battery installation. There is still a pitfall in all types of battery boxes, however, and that is oxidation or corrosion of the brass contacts. Clean those contacts regularly — it only takes a few minutes and may save a ship.

Another item that doesn't seem important is the soldered connection on a battery pack. We all think we know how to make a solder joint, and it isn't until after the crackup that you check and find a wire that fell off a battery terminal box! Check it with a magnifying glass — you will probably find you had a cold solder joint. Try to make a harness out of the wires, or glue them so they don't dangle and vibrate loose.

Finally, I would suggest, that you obtain nicad batteries with the solder lugs in place, making up the pack to the size you need. Thus, no loose batteries, no terminals to clean, plenty of power, and no effect from corrosion by cold weather or standing idle.

—From the Printed Circuit

## NIGHT FLYING

Want to fly all afternoon, into dusk, and way into the evening? Here's a circuit for "running lights" for your plane so that you can tell which way it is traveling by the colored lights, blinking on and off. All that remains is landing lights with a transistorized circuit so as to get a few candle power on the strip.

—From the Printed Circuit

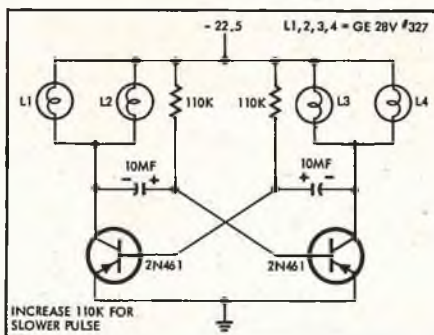

## WIRE BENDING TEMPLATES

Before you bend that wire gear or cabane strut, first take a length of solder and shape it to size. The solder makes an excellent pattern to copy and saves making costly and time consuming mistakes on music wire.

—Illinois Radio Control Association

## DUAL NOSE LANDING GEAR

Here's a simple way to make up a dual nose gear for trike setups. Obtain a standard "tee" fitting as used for tropical fish aquarium air pump connections, costing about 50c at local pet stores. Insert the cut length of piano wire for the axle and strut as shown. Solder, using acid flux and plenty of heat. Wash off the acid and install the wheels. Retain with washers. This tandem wheel nose gear is easy to make, looks good, and should be a big help in stabilizing ground handling.

—Dave Kovensky in the McDonnell 'Carrier Wave'

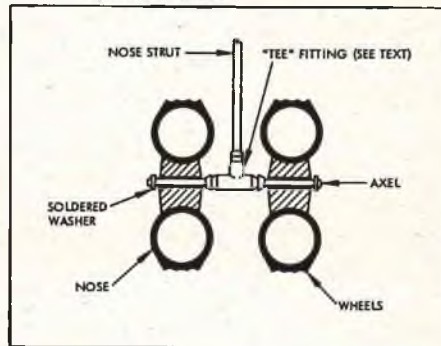

## ON MARKING BALSA

For marking on soft balsa, try a Stabilo pencil (felt tip). It produces a dense black line with very little pressure. Available at art supply houses or stationery stores.

—From the N.A.A. Flightmasters  
**HOLDING SANDPAPER**

Having trouble holding sandpaper when working with balsa forming? Try this idea of interleaving two sheets of sandpaper for a firm grip. It works!

—Jerry Burpee  
in the Sentral Illinois "Sira"

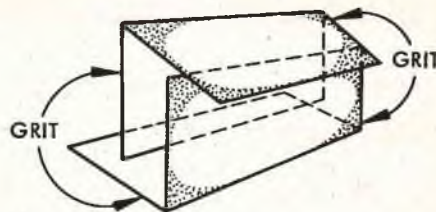

## Coming Next Month RCM'S SINGLE CHANNEL TRANSMITTER

for use with the  
Convertible Superhet

## How To Build the G.E.M. CHALLENGER II

An Approach To Flying  
Proportional  
Part II, by Cliff Weirick

N.M.P.R.A. Pylon Section

Plus Many Other Features

# FLAPS: AND HOW TO USE THEM

by ALAN WALL

*Noted Australian R/C flyer and airlines captain, presents some interesting notes on the use of flaps in present day multi designs.*

Flaps were introduced into full scale aircraft design with the advent of streamlining and higher wing loadings, which made for faster approach speeds and resulting longer landing roll, along with a much touchier control at lower speeds. Today, virtually no new aircraft, from light private planes to the hottest jet, is designed without flaps or some device utilizing similar principles. These same devices can be very useful in model design if basic principles of their use are understood and appreciated.

Basically, the lowering of flaps has two effects:

- (a) The lift coefficient of the wing section is altered.
- (b) The drag coefficient of the wing section is increased.

The lift coefficient is increased up to a maximum with approximately fifteen degrees of flap extended, after which any increase only results in large drag increase without further lift.

The drag coefficient of the wing section is normally balanced out by thrust, or in glide by forward inclination of aircraft weight. Any increase in wing drag from use of flaps will then upset this balance, causing trim changes, unless compensated for by mid-wing design, or in some other manner.

These generalizations are perhaps a little crude, but will give us a basis for discussion and some idea of how to approach the problem. You will have to decide what you really want to add, then use the best means to achieve that end.

In the simplest aircraft — sailplanes — where wing loading is low, increase of lift is not desirable and may cause problems with ballooning approaches. Full-sized machines do use flaps on some designs to lower stalling speeds,

thus allowing tighter turning in thermals, but generally it has been found that drag increasing devices are sufficient. The latter, in fact, also decrease lift, allowing yet steeper approaches to be made into small areas. Anyone who has tried to judge the glide approach of a model sailplane will appreciate this as a decided advantage. Another good feature of "lift spoilers," as they are termed, is that if the approach is misjudged, they can be retracted without loss of lift, allowing the glide to be stretched a little.

On the other end of the scale, the hot ships of today with tiny wings and high loadings dictated by maximum speed requirements, need all the extra lift they can get to lower approach speeds. This often requires the use of leading edge slats in conjunction with flaps to increase wing camber and thus lift coefficient. This increase in lift coefficient simply allows the aircraft weight to be supported at a lower speed, reducing the stalling, or minimum flying speed, whichever you prefer to call it. Extra drag to reduce landing roll can be had by using drag chutes or thrust reverse.

The present day full house model seems to fall somewhere in the middle — wing loadings are not very high, but some lowering of stalling speed could be a definite advantage. On the other hand, the clean designs make for flatter approaches and problems in judgement that can be helped by extra drag. The use of small amounts of flap would also improve takeoff, saving the heaving-off and steep nose up attitude that often results in a stall. Thus, a flap position for maximum lift could be a decided advantage, with additional drag useful on occasion, to steepen the approach. Extra drag had the mixed blessing of requiring

extra power to maintain flying speed, which in turn, means more prop blast over the tail for better control response.

We have found, however, that the extra drag from wing flaps causes an upset in trim, which could be very dicey near the ground. The answer to this is to use a drag producing device in a location which will either not cause any trim change, or where it will actually correct the change caused by the maximum lift flap position. With the latest proportional equipment these settings could be precisely selected, with the control indexed for maximum lift position, followed by degrees of drag as required. This would allow maximum lift for takeoff and circuit flying. Further drag, along with additional power, could be selected for final approach.

For the currently popular low wing designs, I would suggest a simple drag plate be tried on top of the fuselage above the trailing edge, arranged to operate from the flap servo only after the maximum lift position had been reached. This would feature adjustable movement and trimmable area to allow for "cut and try" experiments. Don't confuse trim changes with ballooning which follows flap extension and affects the flight path more than the attitude, the latter which we are attempting to adjust. Remember that air reaction is a function of the square of the speed, and if flaps are lowered at twice normal speed, the lift increase will be four times the normal effect, giving terrific upwards surge until the speed washes off. The correct technique would be to reduce speed with throttle and elevator to just above the stall, then drop maximum lift flap, putting on just enough power to stabilize the model at this speed, then lowering full drag as required for this speed, using power as dictated.

Another aspect of trim that may present a problem in some aerobatic designs is that the center of pressure moves forward when flaps are lowered. This is even more accentuated with some individual wing sections, and if the center of gravity is well aft, may cause bad nose-up changes of trim. If the CG cannot be moved forward to offset this tendency, it may be better to try less critical sections, or coupled elevator trim for compensation. It would seem, however, that a better solution would be to use less flap angle, and in this case, spoilers on top of the wing to introduce more drag **below** the thrust line.

# TOP OUT



The 'Caravelle' by Mel Santmyers. Five feet of Class I beauty typifying design and finish trend for Class I. K & B .45 up front. To be featured in RCM.

## by jerry kleinburg

Below: Class I corner at 11th King Orange, Norm Rhodes, 1st in Class I. Readies his 'Air-Conditioned' while Art Christen of Toledo visits. Lower photo: Harvey Hemke grins after soloing Tri-Squire. Many beginners find multi-rudder easy to handle right off.

The scene is a familiar one.

It's the early Sunday morning combination wrestling match and comic frolic, when the young fry may assert their prerogatives of climbing over a grownup's frame and bouncing on the paunch of their fearless leader — the dealer of favors, allowances, and sternness — their Pop! The event — occurring amid aromas of coffee and bacon, soon loses initial inertia with its flurry of sound and movement, and blends into a sedate phase distinguished by rustlings of the Sunday funnies.

It is here, when the mind filled with the escapism of a Moon Maid or the droll whimsy of a glamorized gargonian of Hi and Lois, becomes conscious of a voice urging attention. Eyes pivot to find a face filled with a six-year-old's earnestness, and as the ear focuses to the sound and the brain sorts its theme, the ambitions of this 36 pound miniature man becomes known.

"I'm going to build two of these and one of those when I start building radio control's pretty soon," he's



declaring. (These and those are Sterling's 'Mambo Special' and 'Skyshark,' in that order.)

"That's nice — only the 'Skyshark' isn't an RC," you point out, mentally noting how soon the scale bug gets its victims. Now full attention is on this progeny as his "pretty soon" turns out to be "...next week — you know — when I'm bigger!"

As your eye-sweeps the room it recognizes the evidences of your hobby — the latest bird hanging on the wall ... a plaque or two ... and amongst the assortment of papers, letters, and magazines on the dresser, the battery charger is putting a head on the transmitter batteries. Realization creeps in that maybe this hobby is no longer a simple personal pastime. The modeling artifacts encroaching in the bedroom and the eager little guy next to you (together with his brother who has his eight-year-old radar tuned into the conversation despite the comics), brings awareness that RC'ing is a commitment involving family and living habits ...

*(Continued on next Page)*

# DO YOU USE REEDS?

If you use a reed receiver, here is the perfect servo for you. World Wide R/C has in stock the famous Bellamatic servo for use with any relayless reed system. (See the excellent article in the Jan. issue of this magazine). We will send you post paid, this husky, light weight (less than 2 oz.) servo COMPLETE with Justin amplifier kit for only a fraction more than the servo alone.

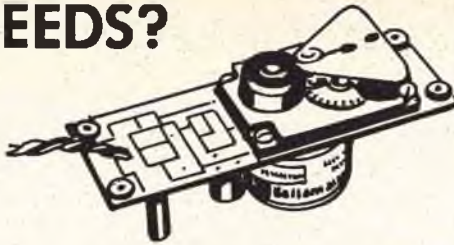

**COMPLETE PACKAGE \$18.95**

**FLASH!! ANDY WRIGHT PROPORTIONAL CONTROL SYSTEM CONVERTS YOUR RUDDER ONLY EQUIPMENT TO A CLASS II PROPORTIONAL SYSTEM (RUDDER, ELEVATOR, & MOTOR). ONLY \$39.95**

**NEW! NEW!** Totally revamped Space Age GO-AC. Smaller! Twice the power of the old version! Less battery drain! Compact enough for 1/2A planes. Plenty of muscle for larger G-G ships.

No C.O.D.'s please We pay the postage

**WORLD WIDE PRICE ONLY \$14.95**

**RADIO CONTROL**

9810 WYOMING, DET. MICH. 48204 RCM4

Clip and paste to card for your free copy of "Quick Blips" or shoot us a dime for the latest World Wide catalog, don't forget your name and address.

Please send me Quick Blips

Here's my dime for a catalog

Circle No. 115 on Reader Service Card

## MUL-T CIRCUIT MASTER

The Printed Circuit Board Designed to Fit YOUR INSTALLATION



Standard size with 4 Transmits Servos

**YOUR SERVOS**  
**YOUR LAYOUT**

MUL-T CIRCUIT MASTER combines servo mounting board with features that eliminate plug failures, that "Rats Nest" of wires and plugs, broken wires through vibration and handling.

MUL-T CIRCUIT MASTER accepts Bonner, Kraft, Anaco or any other popular servos. Servos may be moved to fit your own needs. May be used for 1 channel (with Royals servos) up to including 12 channel relayless installations. Has provision to mount switches, receiver plug and power plug on the board if desired. Measures 2-3/4 wide by 9-5/16 long, but may be cut to as little as 2 wide and 3-1/2 long. This board also can be used to mount all Dush mounted proportional servos. Will not be made obsolete as it is the most versatile board on the market.

MUL-T CIRCUIT MASTER with all these features ..... \$7.95



Set-up with 3 Transmitters

**NEW** MUL-T CIRCUIT MASTER SPECIAL **NEW**

Same as above, except dimensions 3-1/2 wide by 5-1/4 long. This board will take 3 Bonner servos side by side. Accepts all Dush mounted proportional servos. Wiring instruction for reed systems and proportional systems are included.

MUL-T CIRCUIT MASTER SPECIAL ..... \$ 6.95



Single channel set up with 2 Royal Servos

### A First in the R/C History

Why bother wiring? You can have it FREE. Order your new R/C outfit from us. Every make available. Our Experts will do for you a neat, reliable wiring job using the MUL-T CIRCUIT MASTER. Write us,

we will assist you in selecting the right outfit and the best servo layout for your plane.

Free

Free

**FLY-TRONICS**  
**ENGINEERING**

3010 BROOK DRIVE, MUNCIE, INDIANA

## FAIL-SAFE

The Automatic Electronic Control Device for Safer R/C Flying



WEIGHT: 3/4 OZ.  
SIZE: 1-3/4 x 1-1/8 x 11/16.

FAIL-SAFE is the best insurance against loss of your valuable plane.

FAIL-SAFE switches your throttle servo automatically to "motor idling" if you loose control. Suited for high wing and low wing airplanes.

FAIL-SAFE MODEL RL-KIT ..... \$ 13.95 For relayless receivers  
FAIL-SAFE MODEL RL ..... \$ 16.95 with Bonner Transmits

SEE YOUR DEALER, ACE R/C, WORLD ENGINES OR WRITE DIRECT

## Top Out

(Continued from Page 43)

Then you jump to a sitting position. "Hey! The weather's good and the guys were talking last night about trying out some new stuff today," you declare to yourself as much as to anyone else.

"Hon... how about that breakfast," you call. "Are 'ya ready?"

And the answer, a wee bit miffed on the edge, comes back. "As soon as you clear the balsa and tools off the table I'll be able to get it for you!"

You're sure, now. It is a total sort of thing.

### Contest Contrails

The 11th King Orange International is now history and a fond memory. Against the tropical Miami backdrop and the Orange Bowl festivities, with its parades, football, and boating regatta, a finer setting for an RC shindig can hardly be imagined. Clear sunburn type weather and moderate wind combined to top off the contest which featured more out-of-state fliers than Floridians. (Ed's note: "Floridian": A Californian on relief). Although competition in Class I was limited to four contestants, Norman Rhodes, who recently converted from Class III flying, battled successfully to the top spot flying a McCoy .35 powered 'Air Conditioned-Mambo' with Kraft reed gear. Happy to take second was this beat-up pencil pusher using my faithful 15-month old 'Separator.' George Haynes took the 3rd spot, leaving at least one of the Class I trophies in Florida.

Mike Garner was CD, and together with Jim Shaw, current Tropic Aeros RC Club prexy, kept the action moving, much to the satisfaction of the large crowds who were on hand for the three day affair.

Highlight of the festivities was the gab-fest on Saturday night, hoisted—er, hosted by Bob Lien and his Custom Products partners. Had a chance to listen in on Al Kline of Astroguide as he outlined future plans for a low cost Rudder Only proportional radio gear. Also had a chance to hold forth about Class I and to notice the attention the top multi fliers are beginning to give the rudder class as they increasingly recognize its potentialities in light of recent gains.

It was a long drive from Texas to Miami for Emily and myself, but

(Continued on Page 47)



# The Roostertail



The Official Publication of the International Model Power Boat Association  
 General Office: 2405 19th Avenue Broadview, Ill. 60155

Following last month's column, here is more on the 16th Annual Regatta at Cape Coral, Florida. All classes are scheduled in both Tether and RC. In the event that the number of participants in any one class is below the required minimum, classes will be grouped as required in order to give everyone an opportunity to participate.

Tether facilities will be set up on one end of the lake and RC at the other. Ed Kalfus, of the New York MPBC, personally went to Cape Coral and pronounced the lake "perfect" for both hydroplane and radio controlled classes. RC events will include the new balloon busting course, approved in the last election as the precision event. This gives everyone an even break, since no exceptional depth perception is required, and since the point of the tack is the same size no matter how large the hull. The inequities of the precision event have practically been cancelled, thus making the skill of the operator the main factor in winning — not the size or shape of the hull.

RC racing will include both the 1/4 mile Oval and the Straight 1/16 mile speed course which requires one pass in each direction during the same run in order to take the average speed for the two passes.

The annual business meeting and banquet will be held Saturday, July 3, after the first day of competition. The votes are in and have been counted from the ballots which were sent to all members of record on January 1st, 1965. All the measures carried except the proposed change in proxy running. Sharp eyes noticed that there were some omissions in some of the statements, and some ambiguities were pointed out in pencil on the returned ballot. These notes were all taken into consideration, and in many cases, were

incorporated in the wording of the Rule. Those of us who drew up many of the proposals were, perhaps, too close to the problems involved to see any other way to interpret the wording which was chosen. Many thanks to those of you who took the time to express your opinion by returning the ballots.

Officers elected to serve the IMPBA for the terms indicated, are:

President: Mert Mischnick, Broadview, Ill. (Exp. 12/3/66)

Vice President RC: John Zwack, Richland, Mich. (Exp. 12/31/67)

Director Technical Correspondence: Frenchy LaJeunesse, Concord, Calif. (Exp. 12/31/67)

Director, Forms & Printing: Cy Crites, Alamogordo, New Mexico. (Exp. 12/31/66)

Write-in votes for officers: President, 3; Vice President RC, 3; Director of Technical Correspondence, 1; Director, Forms and Printing, 0. If those of you who wrote in your preference for officers would have nominated these men when nominations were in order, perhaps they would have had a chance to win. As it was, none of the men elected were opposed. Once again you have the opportunity to nominate the man you feel is most suited to be an officer of the IMPBA. **NOMINATIONS ARE IN ORDER** for the following offices:

Vice President Tether Division: Incumbent, Pete Yanczer, Roch Hill, Mo.

Director of Records and Awards: Incumbent, Bill LeFeber, Indianapolis, Ind.

Let us hear from the membership!  
**D. The Race** (Phase three — running the course)

**MULTIPLE BOAT RACING  
 RULES (Continued)**  
 (Continued on Page 46)

CUSTOM PRODUCTS  
 1222 Green Acres Rd. Metairie, Louisiana  
 Ph. 884-222-7447 zip code 70003

...Products of Quality...

Jim Kirkland Bob Lien  
 Stan John Les Sanborn

## HAPPY WINGS

\$12.00



TRUE  
 RUGGED  
 LIGHT  
 4 OZ./PANEL

### SOLID ARMALITE® CORES

TAURUS, JENNY, CANDY, STORMER, FALCON,  
 FALCON SR., BEACHCOMBER TYPES AND  
 NEW BOSCH AIRFOIL KWIK-FLI TYPE

Includes L.G. blocks,  
 servo cut-out and instructions.

STAB CORES FOR ABOVE .....	3.75
5" SURGICAL HEMOSTATS	
Straight or Curved .....	3.95
2" VECO SPINNERS	
Milled to accept prop .....	1.35
RUDDER TO NOSE GEAR BELLCRANK	
Adjustable .....	.35
ANODIZED RADIAL MOUNTING PLATES	
Specify ST .56, 60 or Veco .45 .....	2.45
BRAKE CABLE, Non-stretch, flexible.	
Fibreglass, nylon .....	.75

WRITE FOR FREE A.M.A. PATTERN  
 WALLET CARD  
 DEALER'S INQUIRIES INVITED

Send Cash, check or money order. Orders under \$3.00 add 25c. Louisiana residents add 2% Sales Tax. Outside U.S.A. remit by International Money Order and add 10%.

Circle No. 116 on Reader Service Card

## HALF-TIME

4 To 10 Channel Trainer



HALF-TIME... That's the name, and that's how long it takes to build it. Build the wing & tail and you're ready to fly. Extremely simple and fast construction. Pre-cut and notched ribs and spars. FEATURES the only completely finished FIBERGLASS fuselage available with 2 or 3 COLOR HIGH GLOSS FINISH, molded right in. Available in all basic colors. Fly this 56" span model with .19 to .29 engine. 2415 airfoil, 560 sq. in. Fuselage weighs 16 oz. Ready to fly — 4-4½ lbs. Full size plans.

\$24.95 w/wood

\$16.95 Fuse Only

\$ 8.95 Wing Kit

Calif. res. add 4% sales tax

Your money returned if we cannot make immediate shipment. If not available at your dealer — Send direct

R & L MODEL SPECIALTIES  
 P. O. BOX 253 CAMARILLO, CALIF. 93010

Circle No. 117 on Reader Service Card

# All R/C Top-Name kits, components, accessories

**SOLD • TRADED**

Only ALLIED HOBBIES gives you full trade-in value on R/C equipment no matter what your purchase. Take advantage of present low sale prices without taking a total loss on what you have. **YOUR PRESENT EQUIPMENT MAY EASILY COVER THE ENTIRE COST OF A NEW ITEM.** Send stamped, addressed envelope for special trade-in forms.



**It's What's Up Front That Counts!**



## KUSTOM 51 R/C

- MEEHANITE SLEEVES • BUILT-IN CARBURETION • 2200-11,000 RPM RANGE • SINTERED IRON RINGS • \$30 PLUS TAX AND POSTAGE

Kustom '61' R/C available for **\$37.50**

**KUSTOM ENGINES** BOX 2347 FULLERTON, CALIF.

**THE WINNING COMBINATION**

THE "SUPER CHALLENGER" \$49.95

• 40" long • 20 1/2" wide • all fibre-glass construction for greater strength and durability • kit complete with hull, deck, cowling, plexiglass windshield—plans, building and trimming instructions • proven and tested

AND

"TAS" ENGINE

• high torque • recoil starter • 18,000 volt ignition system • water cooling available • ruggedest construction in the industry • 1.31 cu. in. • wt. 5 lbs. 3 oz. • ht. 6 1/2"

MODEL P-7 \$41.00

• 9000 RPM. • ALSO AVAILABLE — TAS MODEL P-5 — \$35.00

**G.E.M.'S OTHER FIBRE-GLASS KITS...**

MARAUDER—29 1/2" L.—8 1/2" W.—15.—35—\$19.95  
 P. T. BOAT—39" L.—10 3/4" W.—19.—35—\$16.95  
 CHALLENGER JR. 27 1/2" L.—13 1/2" W.—15.—35—\$32.50  
 CHALLENGER II 36 3/4" L.—17 1/2" W.—45.—60—\$39.95  
 COBRA—49" L.—16" W.—45.—65, TAS, O & R—\$49.95  
 WHITE HEAT X—42" L.—16" W. TAS, O & R—\$49.95

**G.E.M.'S TERMS...**

F.O.B. LOMBARD, ILLINOIS — SORRY NO C.O.D.'S  
 ADD 10% THE COST OF THE ORDER FOR SHIPPING CHARGES (\$5.00 MAXIMUM IN U.S.A.) DEALERS' INQUIRIES INVITED.

**G.E.M. MODELS** 48 W. LE MOYNE LOMBARD, ILL.  
 Distributors For — Cameron - Tos

1. Laps are counted with the first crossing of the start line as zero and with each consecutive crossing of this line an additional integer until six legitimate consecutive laps are completed. The first boat to legitimately complete the sixth such lap is declared the winner.
2. Cutting a buoy or buoys by a boat requires that boat to circle the buoy, or buoys, in question before proceeding. A lap cannot be legitimately counted unless any buoy cut during the course of the lap be circled as above. Should a buoy be cut, and not circled as required, no further laps may be counted as complete.
3. In the event that no boat finishes the required number of laps, a "no contest" shall be declared.
4. Keeping track of laps is the responsibility of the contestant and his pitman. Although judges are tracking laps, it is not their specific responsibility to so notify the entrant.

### E. No Contest

1. If an obstruction is observed on the course, which in the opinion of the judges, could cause any boat to be damaged, or could otherwise alter the outcome of the match, a "no contest" shall be declared.
2. If in the opinion of the judges, unsportsmanlike conduct is observed on the part of a contestant or his pit crew during a match, a "no contest" shall be declared.
3. If no boat completes the course in a total of 12 minutes commencing from the start of port time, a "no contest" shall be declared.
4. Other "no contest" situations are noted in Sec. II, A par. 3 & 7, and Sec. II, D par. 3.

### F. Retrieving

1. Ordinarily, once a boat is under-

way, any retrieving activity is absolutely prohibited. It has been found that under certain very restricted conditions, retrieving does not detract from, nor in any way prejudice, the outcome of the race as a contest.

2. Retrieval is allowable only as follows: A contestant may recover his boat for adjustment and re-enter the race provided that (a) the retrieval is allowable by the judges on the basis that unfair impediment of other boats is unlikely to occur, (b) he forfeit entirely any laps he may have accrued prior to handling (c) other contestants are still in operation in any phase of the race (d) he complete the race (6 laps) in a total of 12 minutes elapsed time counting from the initiation of port time.

### G. Contest Equipment

1. In addition to the IMPBA marked International Oval, the following items are essential for running a multiple race: (a) a visible clock, the face of which should be one foot in diameter, or larger, with a white face and a single black pointer. A vertical mark placed on the '12' position should be the only dial marking. It should be suitably geared and should contain a provision for adjusting time of one full revolution for an interval of not less than one full minute and not more than 70 seconds. (b) a gun for starting, or, if unattainable, other means of a short, sharp sound or visual signal. Should a gun not be available, contestants should be made fully aware of the substitute signal prior to the match. (c) a stop watch for each entry for pace boat operation plus one for port time and/or full 12 minute time.

**APPLICATION FOR MEMBERSHIP TO THE I.M.P.B.A.**

I.M.P.B.A.  
 2405 S. 19th Ave.  
 Broadview, Ill. 60155

1 Yr. Dues, including 1 Yr. subscription to R/C Modeler,  
 USA \$6.00; Canada \$6.50; All Other Countries \$7.00     \$ \_\_\_\_\_

Special 1 Yr. Dues (without R/C Modeler subscription) \$2.50     \$ \_\_\_\_\_

Family Rate: \$.50 each additional member (one address)     \$ \_\_\_\_\_

Total \$ \_\_\_\_\_

Name(s) \_\_\_\_\_ I.M.P.B.A. # \_\_\_\_\_

Address \_\_\_\_\_ City \_\_\_\_\_

State \_\_\_\_\_ Zip \_\_\_\_\_ Country \_\_\_\_\_

Interest: Teacher \_\_\_\_\_ R/C \_\_\_\_\_ Club \_\_\_\_\_

## Top Out

(Continued from Page 44)

we're promising ourselves another winter holiday in the sun and palms (no, not hands!) of Miami come the next King Orange.

A short time after the Miami trip, I had the opportunity to drop in on Bill Knost and the Tulsa Glue Dobbbers in their Oklahoma stronghold. We found the fliers there receptive to Class I ideas, although current rudder flying represents only a small percentage of the total activity. Big Bill runs a model shop — not fancy, but full of the items RC'ers like around, judging from the steady procession of customers. Bill's influence in Class II (he took 3rd at the Dallas Nat's) is noticed, and together with Dale Nutter, Jerry Krause, and Ralph Moore, set the RC contest pace in Tulsa. Al Solnok, the club sparkplug and idea man, gave me some human interest material that'll be seen in this column in upcoming stints.

Real insight, that boy has...

### Bits and Pieces

Gary Wedge of Alhambra, California sends along a dandy idea for a new approach in rudder flying. This bright young fellow got his thinking cap on and came up with a design he dubbed the 'Twister,' based upon its central theme. The principal idea is to have two rudder surfaces, one above and another below the fuselage centerline, and through a pair of interacting servos, provide yaw left or right when both rudder halves act in the same direction. Longitudinal roll in either direction is then sought by having the rudder halves actuated in opposite displacements. Gary doesn't provide full details, but it is through a set of switcher plates that he envisions obtaining the necessary interaction of the servos. The system, although not legal under current Class I contest rules, deserves further attention and development. Interested experimenters may reach Gary for more details at 823 Edith Ave., Alhambra, California.

Sharing our masthead this month is Mel Santmyer's Class I beauty, 'Caravelle.' The design is over two years old and Mel has taken it from escape-ment to multi-rudder equipment. Featuring a long nose moment, detachable vertical stabilizer and semi-symmetrical airfoil, the graceful flier is powered by a K&B .45 and spans 60 inches.

(Continued on Page 50)



## THE CHEROKEE

**BIG CHIEF MULTI-PILOT FLY CHEROKEE!**

FLY WITH REEDS OR PROPORTIONAL  
FULL LENGTH DIE CUT SIDES!  
VACUUM FORMED WINDSHIELD!



**\$24.95**

KIT INCLUDES  
OUR OWN COIL SPRUNG  
STEERABLE NOSE GEAR

SPAN 65"  
AREA 754 Sq. In.  
AIRFOIL 18" SYMMETRICAL  
POWER .40 - .46 .51

Send stamp  
for literature

**VK MODEL AIRCRAFT CO.**  
4350 ARONDALE DR., WILLIAMSVILLE 21, N. Y.

Dealers — Reg. Dis.  
If your jobber can't  
supply order direct

## COMPLETELY FINISHED AND READY TO FLY

1. High impact flexible polyethylene
  2. Will attach to any conventional landing gear (de-Bolt or wire type)
  3. Operates equally well off water, sand or snow
  4. Strong and durable, will not puncture on ground landings
  5. Can be attached and removed in less than 3 minutes
  6. Mounting bolts, spreader bars and wire included
  7. Lightweight
  8. Finished in aluminum color (At present available in two sizes)
- OTHER SIZES BEING DEVELOPED

### The GEE BEE Line

Box 347/Forest Park Station/Springfield, Massachusetts



**NEW**  
**33" FLOAT**  
Models Up to  
7 1/2 Lbs.  
**\$12.95**

AT YOUR  
DEALER OR DIRECT  
19 1/2" FOR .02 to .074 **\$5.95**  
MAX. MODEL WT. 28 ozs.  
WT. PER FLOAT 1 3/4 ozs.  
28" FOR .09 to .29 **\$8.95**  
MAX. MODEL WT. 72 ozs.  
WT. PER FLOAT 3 1/4 ozs.

Circle No. 122 on Reader Service Card

**BUY THAT NEW  
PROPORTIONAL  
OR REED EQUIPMENT  
with your...**

## BANKAMERICARD

*The Family Credit Card*

*John J. Nelson Jr.*

AUTHORIZED SIGNATURES

J J NELSON JR  
12/64  
160 350 419 BA

Wilshire Model Center • 1326 Wilshire Blvd. • Santa Monica, Calif.

**EXCLUSIVELY EXPORT...**

**EXCLUSIVELY R/C!**



**EXPORTATIONS export specialists**

5061 Alhambra Ave., Los Angeles 32, Calif., U.S.A. ■ CA 1-6968 ■ Cable "EXTRONIC"

## Babcock '27'

(Continued from Page 36)

which in turn, directly drives the rudder-elevator escapement. In addition, another output transistor drives the motor control escapement. This very high selective audio frequency allows a super-regenerative detector to be used with immunity to CB interference — the latter being caused by modulation at much lower frequencies. The audio selectivity of this receiver is so great that an exact adjustment of the transmitted modulation frequency is required. This is accomplished by the Tone adjust function on the '27' transmitter. Power supply for the receiver and escapements consists of two 9-volt transistor batteries.

**Escapements.** The compound escapement used for selective control of the rudder and elevator surfaces is a recent development of Babcock Controls. Spring centering has been installed at the factory so that no external control surface springs will be required on the smaller aircraft in the .020 size. Additional centering will be required on models larger than this. Static and aerodynamic balancing is also necessary for models in the .15 displacement category.

Bonding for noise suppression has been built into this 9 volt escapement. Torque rod stubs have been pre-installed, and universal joints included, for ease of installing the aircraft torque rods while reducing any chance

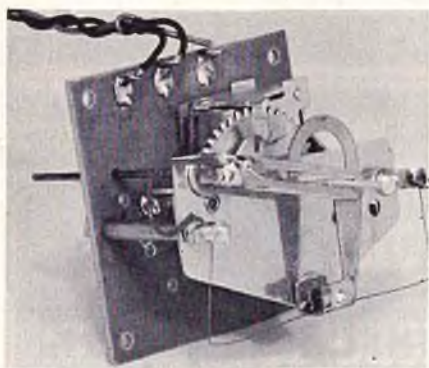

A new concept in escapements—torque rod arms in place for rudder and elevator. Note centering springs for smaller-sized ships. Loop of hook-up wire on left is bonding for noise suppression.

of torque rod binding. The throttle control escapement is of the two-position variety and is complete with its own mounting bracket and drive rubber.

**Price and Availability.** The Babcock '27' is available only as a complete system and priced at \$79.95. It is currently in production and available at all Babcock Factory Representative Dealers, or direct from the factory. '27' system owners may purchase additional receivers, escapements, etc. separately, as desired. A charger for "topping-up" the 9-volt transistor batteries is available separately for \$4.95.

### Findings

Three of the Babcock '27' systems were selected for testing by RCM. They were installed in a D.Q.A. 704 (.049 version) and in the Schoolgirl design by Ken Willard (.049). The manufacturer's instruction manual accompanying the system is one of the most complete brochures of its kind we have seen and leaves very little to the "trial and error" process. The entire '27' system takes only a few minutes to install, but the single channel sport flier is cautioned to take time to pay close attention to details. This is an escapement system, and although most of the "tinkering" and tedious bench work has been eliminated by the manufacturer, all of this engineering consideration cannot overcome a sloppy installation hastily made. Make sure there are no binds in your system, that your escapement rubber is of the proper type and length, that you run the escapement through several hundred times on the bench to make sure there are no burrs that will cause it to hang up. Be sure your hinges are free of dope and glue and are connected to the torque rod arms without any form of binding or constriction. On the motor control escapement, make absolutely certain the pushrod runs as straight as possible to the throttle arm, eliminating any unnecessary bends or areas of friction.

Quite a few flights were made with the Babcock '27' system over a period of several weeks. The system proved to have more than adequate range when tuned according to the manufacturer's instructions. The quick blip function worked at all times and regardless of the position of the aircraft with reference to extremes of range.

1 1/4" square escapement mount facilitates easy installation. Note torque rod wires stubbed out ready for "universals." Thin wire arm and shim brass strip is quick blip contact.

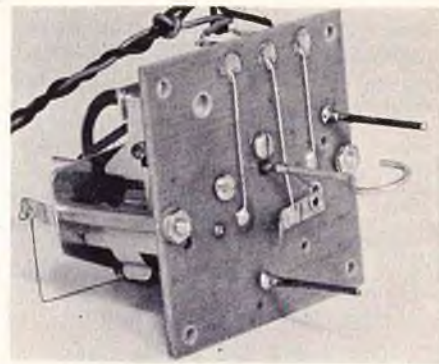

No problems of interference were encountered despite the fact it was continuously tested in an area congested by CB voice channels.

It is apparent, as mentioned earlier, that the manufacturer has intended the '27' system to fill a definite void in single channel sport flying. Offered as a pre-tested, complete system at less than \$80, it offers the sport single channel enthusiast a method of obtaining rudder, elevator, and throttle control without spending \$200 for a six channel reed rig. To be sure, the Babcock '27' is not intended to compete with the reed systems, and as an escapement system, will not perform the same functions. Rather, it is intended to control the smaller variety aircraft, enabling the pilot to obtain a maximum amount of control, flyable from small local fields, at a minimum expenditure.

RCM find the Babcock '27' system to perform its intended functions admirably and with considerable improvement over any other form of cascaded or compound escapement setups available in the past. The manufacturer states that although motorized actuators were originally considered for this system, the weight and space requirements for them precluded their use in smaller aircraft and also substantially raised the manufacturing costs to a point where the list price would have been above the \$80 mark. As it stands, the single channel devotee with some experience in rudder only flying, and with careful attention to installation details, should reap many hours of flying pleasure from the Babcock '27' single channel system.

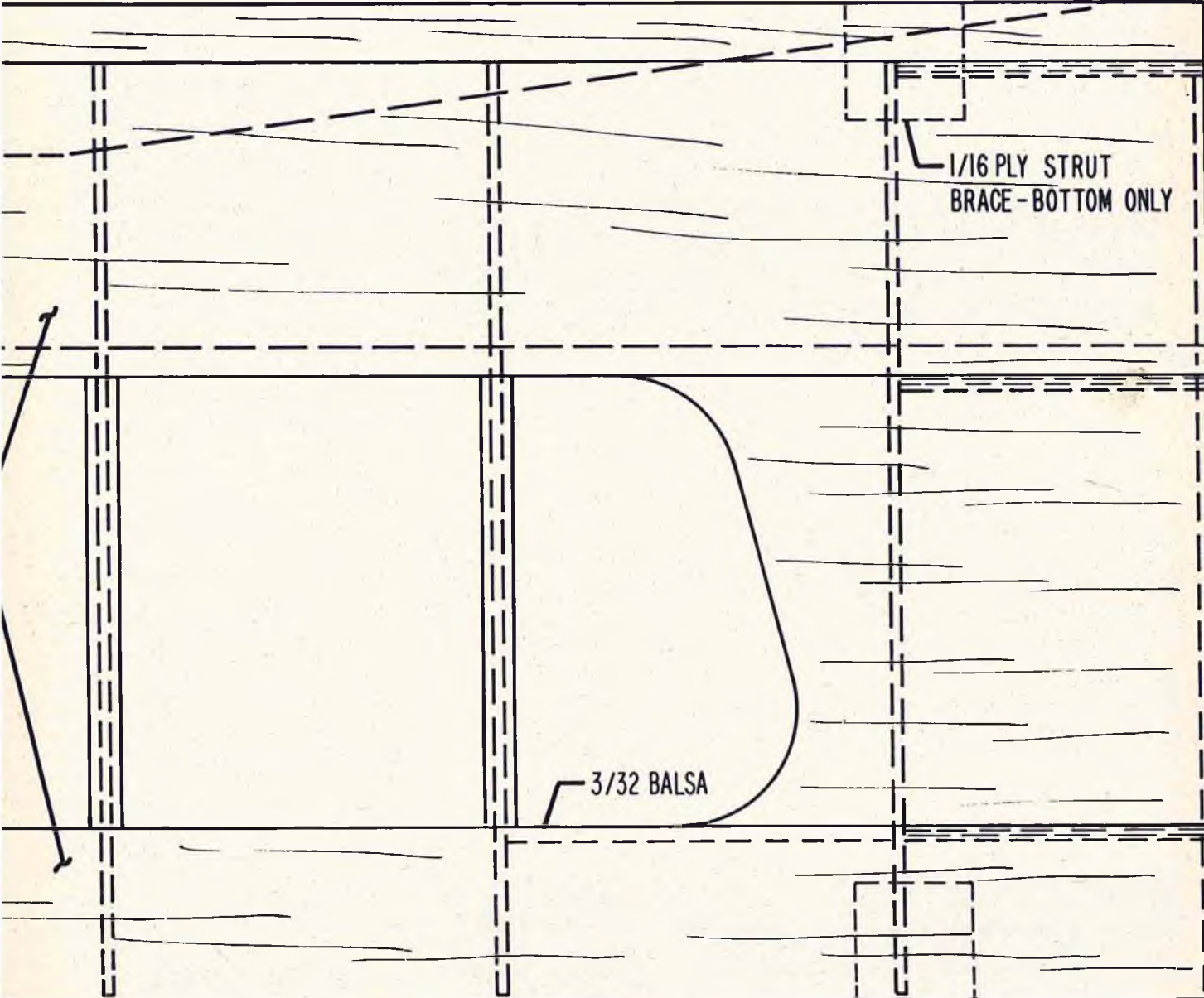
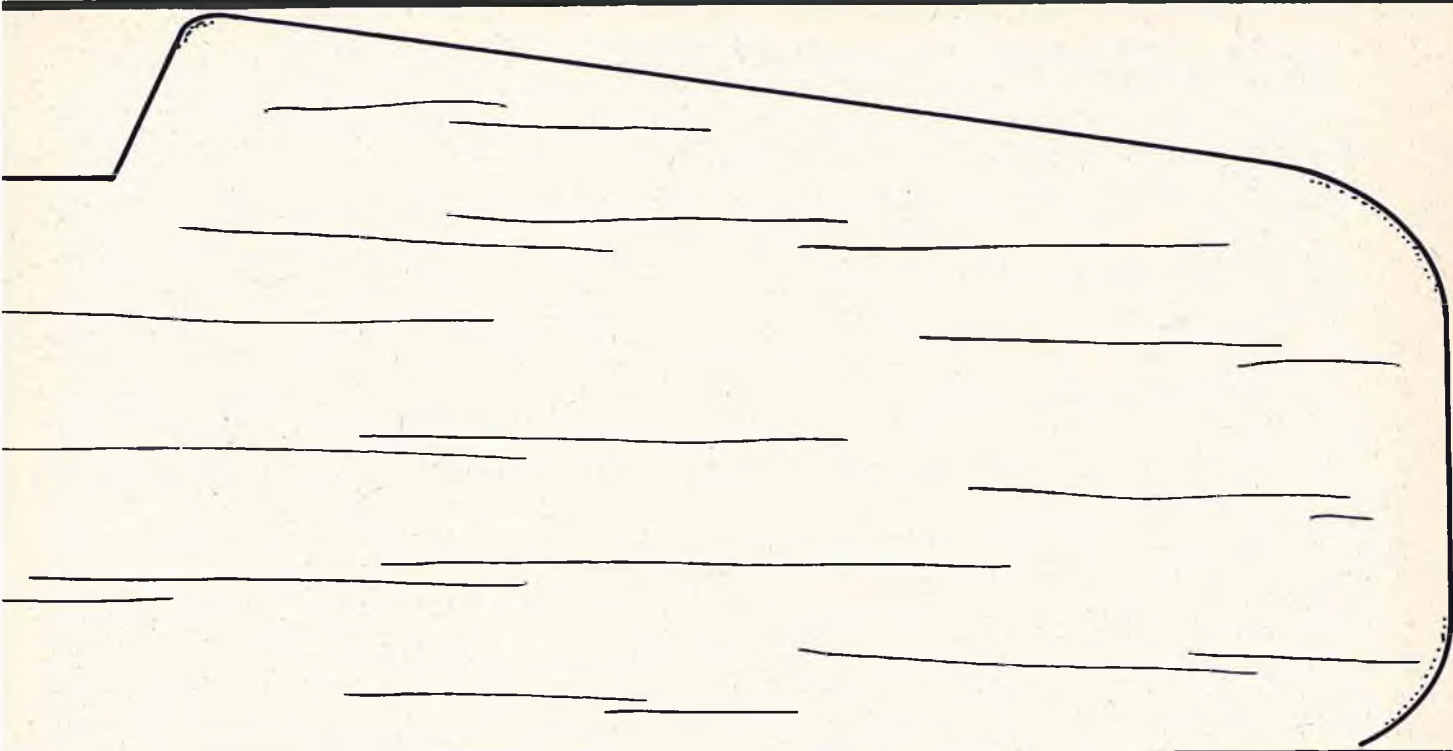

# COMPLETE KITS AVAILABLE FOR THE RCM CONVERTIBLE SUPERHET

COMPLETE KITS for the RCM CONVERTIBLE SUPERHET are now available. All kits contain top quality components plus instructions to construct the superhet receiver designed by Don Mathes and appearing in the April issue of R/C Modeler.

RELAYLESS SINGLE CHANNEL  
**\$19.95**

6-CHANNEL VERSION  
**\$34.95**

RELAY SINGLE CHANNEL  
**\$24.95**

California residents add 4% sales tax. All orders filled promptly but allow two weeks for delivery.

R/C KITS, P.O. Box 385, Arcadia, Calif.

Please enter my order for the following kits:

\$ \_\_\_\_\_ Amount enclosed

\_\_\_\_\_ Relayless kits at \$19.95

\_\_\_\_\_ Relay kits at \$24.95

\_\_\_\_\_ Six channel kits at \$34.95

NAME \_\_\_\_\_

ADDRESS \_\_\_\_\_

CITY \_\_\_\_\_

STATE \_\_\_\_\_

Circle No. 123 on Reader Service Card

**BROADFIELD'S**  
newest --- **UNI-WING-A-JIG**

with ---  
**QUICK ASSEMBLY & COMPLETE ADJUSTABILITY**  
Authentic type jig-structure suitable for building leading R/C WINGS & STABS.; constant-chord or tapered up to 72" span & 12" chord, plus any rib-spacing 3/4" up.

**FEATURES:**

- Aluminum-channel JIG SPARS which secure (RIB-HOLDERS) in desired rib-spacings.
- Notched Cross-Bar members secured to CHANNELS with TAP SCREWS - makes rigid, no-warp JIG frame.
- JIG components (plywood)-(SLOT-LOCK) in JIG to ALIGN (L/T edges) with RIBS for (cement-up) of ENTIRE wing.
- Dihedral-props support HINGED sections for any degree set-up

R/Cers write: "...great innovation in building-JIGS...amazed at its versatility." R/C Modeler-staff builder reports, "I find the UNI-JIG particularly useful in constructing symmetrical airfoils."

Uni-Wing-A-Jig (U-WJ72) \$21.95 with STAB, set-up included & instruction sheet.

**WHO HAS IT? • Ace Radio Control • Your Hobby Dealer; ORDER DIRECT.**  
**BROADFIELD AIR-MODELS**  
ASHLAND, MASS. 01721

*For the Utmost in Advanced . . .*  
**ENGINEERING, QUALITY, AND RELIABILITY**  
*...DEPEND ON KRAFT*

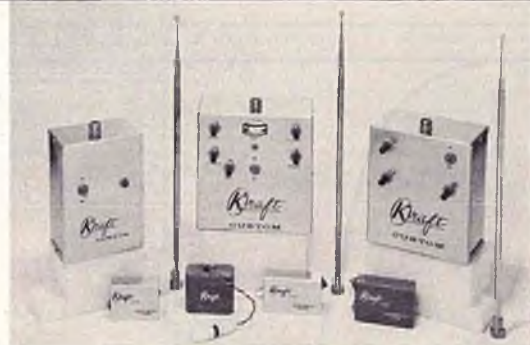

All Kraft transmitters are exceptionally powerful, drift free, and operate from inexpensive, long-life, dry batteries. The 6, 10, and 12 channel transmitters are dual simultaneous. All Kraft receivers use the same basic superheterodyne circuit whether single channel or proportional. The reed receivers are the smallest and lightest available.

**Kraft Matched Sets — Transmitter with Superhet Receiver**

1 Channel	6 Channel	10 Channel	12 Channel
<b>\$64.95</b>	<b>\$119.95</b>	<b>\$189.95</b>	<b>\$209.95</b>

Kraft Proportional System  
(now in production)  
complete system with all  
accessories, ready to install  
**\$489.95**

Kraft Heavy Duty  
600 Mah Reed Battery Pack  
**\$19.95**  
With matching charger  
**\$23.90**

*Kraft Custom Radio Control*  
2519 Lee Avenue • South El Monte, Calif.

All Kraft Custom Radio Control products are available through your local Kraft Franchised Dealer. If unavailable, you may order direct from the factory. Be sure to include check or money order for items ordered. If you prefer, you may send a 50% deposit, balance C.O.D. Calif. residents add 4% sales tax.

Circle No. 124 on Reader Service Card

## Top Out

(Continued from Page 47)

Although Mel doesn't say so in his letter, our guess is that the 'Caravelle' weighs in at about 4 1/2 pounds for an 18 to 20 ounce wing loading per Mel's usual building style. The ship represents a pioneering style which will be seen more and more in Class I.

Mel also proposes some interesting Class I rules that will be presented in next month's column, in which is planned a comprehensive review of rules for rudder competition along with a set of proposals for future development.

Receiving Mel's letter reminds me of a feature I've been meaning to bring to Top Out readers. The idea is to renew my insurance and to present a listing yearly of the top Class I fliers, who, through contest performance or development efforts and service, have conspicuously advanced the art and cause of Class I flying. Those listed will achieve the distinction of the title of Class I Cavalier, and all faithful fliers are called upon to give deference to their distinction by trying to beat the socks off them at any and all contests! So, without further ado, we present **TOP OUT'S TOP TEN FOR 1965!**

- Bob Angus — Tucson, Arizona
- Jackie Gardner — Jackson, Miss.
- George Gorden — Toledo, Ohio
- Ben Harr — San Antonio, Texas
- Harrison Morgan — Suncook, N.H.
- Hans (Pete) Petri — San Antonio, Texas
- Courtney Smith — Kansas City, Mo.
- Mel Santmyers — Warren, Mich.
- Bernie Williams — Kalamazoo, Michigan
- Tom Williams — Oklahoma City, Oklahoma

Nominations for 1966's Cavaliers will be gladly received during the remainder of 1965. Simply jot the name on a card, odd piece of paper, or on the back of an old ten dollar bill, and together with a brief reason for your rashness, send it along to RCM where it'll get appropriate attention.

Snapped a picture of Harvey Hemke of San Antonio right after his recent first solo. The happy smile tells the story of how his six channel Tri-Squire with Citizen-ship and McCoy equip-

(Continued on Page 55)

## Bonner Digimite

(Continued from Page 31)



portional pilots, acclimated quite rapidly to this stick configuration, taking new un-trimmed airplanes and flying many successful flights without incident.

A dual meter is provided in the upper right corner of the transmitter, reading either RF output or power supply charge rate. The antenna is a 54", 5-section telescoping unit which collapses to 12". The transmitter itself has a relatively high output with one watt input. Selection of electronic components is more than adequate. Silicon transistors are used throughout. The PC board is plated. Externally, sheet metal work is excellent with the overall level of workmanship typical of the high Bonner standards.

**Receiver.** The Digimite receiver is a superhet built on a two-deck configuration, the top deck containing the detector and part of the logic circuit, while the lower deck contains the balance of the logic network. There is a great deal of cabling from the receiver due to the availability of eight channels of control. This, however, is remedied simply by taping back four of the cabled leads if the flier is using only four channels of control. The physical size of the receiver is 3" x 2" x 1½". The unit under evaluation was found to be very close to the optimum tuning point as delivered from the factory.

**Servos.** The new Bonner feedback servo is the first unit we have seen that has taken advantage of good engineering techniques, thereby giving the modeler something they need in the way of a versatile and adaptable servomechanism. The output arm is in the geometrical center of the servo so it can be turned end-for-end without consideration of pushrod position. The servo, itself, is of "clamshell" construction, both halves moulded in a

high-impact plastic. The PC board and all internal workings are held in the servo without benefit of hardware. The two halves, when placed together, have four spring clips that keep the servo locked together. All mounting hardware is supplied. All servos are interchangeable with each other with the single exception of the throttle servo. The servo motor is similar to that used in the popular Transmite reed servo, but with a redesigned case. In addition, the permanent magnet used is of the ring type.

Overall servo size is just slightly smaller than the Transmite — 3¼" x 1¼" x 1" with a weight of 3.25 ounces. Thrust is 3½ pounds with a .62 inch travel.

The approach to the distribution of the thrust forces from the control rod are quite novel. The output arm is part of a plate that has a groove on each side. Inside the servo case halves are mating grooves. Fourteen ball bearings to a side fill these grooves, giving in effect, a rack motion that is ball supported. From our experience, this is an excellent way to distribute thrust forces while keeping the thrust arm in perfect alignment with a minimum amount of friction. The use of these ball bearings is one facet that should deter the Digimite owner from indiscriminately opening up his servos, for when the halves are parted, the balls end up hung to the motor magnet, under the PC board, or worse yet, on the workshop floor in the balsa dust! It is suggested that servo service be performed by the Bonner factory, although this is certainly not mandatory if procedural care is exercised.

The Digimite servos are available in two interchangeable styles — center fail-safe and end fail-safe. (The former is used on control surfaces while the latter is used on the throttle). On the four auxiliary channels, either type may be used, however most functions such as flaps or retractable gear would be most suited to the end fail-safe type.

**Battery packs.** The Digimite Power Supplies are built for Bonner Specialties by General Electric specifically for this system, and both the receiver and transmitter units are rechargeable nickel cadmium supplies. The charger for both the receiver and transmitter is built into the transmitter. A TV type cheater cord is used to energize the charging circuit. The receiver battery pack plugs into the bottom of the transmitter for

charging at a rate of 40 milliamperes for 24 hours. One good feature is that neither power supply can be charged alone — both must be charged simultaneously.

The airborne power supply is terminated in such a way that the wiring harness and switch supplied with the Digimite system may, or may not, be used at the discretion of the owner and dependent upon his particular installation. We did note that the wires from the airborne power supply terminate in a solid busbar that is difficult to deflect, making the pack ¾" longer than is necessary and giving some doubt as to what would happen if they were bent back. However, no problems were encountered during flight tests.

**Installation and Tuning.** Installation of the Digimite system is quite simple and standard reed practices can be followed. The receiver is packed in foam, as is the battery supply. A servo tray is not mandatory since the Bonner servos can be mounted from the bottom, left, or right sides and proved to be very simple for direct mounting to airframe sidewalls. The manufacturer asks that metal pushrods, or metal-to-metal linkages not be used due to their introduction of noise to the digital circuitry. We used Williams Bros. nylon clevis's in all positions and experienced no mechanical noise problems. Fairly large pushrods should be used in all models, as under some G loads, flexing of light pushrods can cause trim movement. It is recommended by RCM that no less than ⅜" square balsa pushrods be used in any plane.

The antenna was run out the top of both models and back to the tip of the vertical stabilizer, the best position in relation to the pushrods.

Tuning is accomplished in the installed position. Be sure that the receiver is positioned with the tuning slug easily accessible. A tuning wand is supplied with the system, along with a well-written manual on theory and installation instructions.

**Price and Availability.** The Bonner Digimite system sells complete with transmitter, receiver, four servos, power supplies, and charger for \$615. It is available through all major distributors for sale to the customer through local hobby dealers.

### RCM Findings

The test ships used by R/C Modeler  
(Continued on Page 54)

# STANTON R/C

4734½ N. MILWAUKEE AVE • CHICAGO, ILLINOIS PHONE /312-545-8185

## COMPLETE MAIL ORDER SERVICE

If you have seen, read about, or heard about any piece of model equipment we probably have it in stock. We are active model builders serving model builders. Whether your interests are R/C, F.F., U.C. Indoor, Ships, we are able to serve you. Send us your needs. Cash, check or money order preferable.  
**WE WILL SHIP C.O.D. IF YOU DESIRE!**  
 ADD 25¢ POSTAGE ON ALL ORDERS UNDER \$5.00



#4  
**NICKLE  
 CAD  
 CELLS**

Ideal for TX power supplies, for starting batteries and for electric powered boats. Nominal voltage per cell is 1.25v. ONLY .....\$1.98

*Berkeley's*  
**76 DIFFERENT BERKELEY KITS AT CLOSEOUT PRICES. SEND FOR COMPLETE LIST!**



**SUPER NAVION**



KIT NO. 2-1 R/C • FREE FLIGHT • CONTROLINE  
 68" SPAN .23-65 MOTORS \$24.95

**SPECIAL .....\$21.50**



**ZIMTAC  
 TACHOMETER**

THE ZIMTAC IS AN ELECTRONICALLY CALIBRATED, DIRECT DRIVE, INSTANT READING RPM INSTRUMENT. TWO MODELS. 0-25,000 & 0-10,000 ..... ONLY \$18.95

**SILK . . . 17 COLORS**  
 RED, PINK, BLACK, WHITE, ORANGE, PURPLE, GREEN, M. GREEN, L. BLUE, M. BLUE, DK. BLUE, GOLD, BROWN, YELLOW, AQUA, FLUORESCENT PINK AND FLUORESCENT GREEN.  
 BUY 1-50 YARDS CONTINUOUS PIECE .....PER YARD \$.79

**GAS MODEL SILKSPAN**  
 RED — BLACK — YELLOW — BLUE  
 LARGE 20"x30" SHEET .....only \$.12

**SILK-RAYON**  
 RED — WHITE — YELLOW  
 1 to 50 yds. continuous piece . .per yd. \$.79

THE MIDWEST'S LEADING MODEL HOBBY SHOP

STANTON R/C INC.  
 4734½ N. MILWAUKEE AVE., CHICAGO, ILL., 60630

NAME \_\_\_\_\_

STREET \_\_\_\_\_

CITY \_\_\_\_\_ STATE \_\_\_\_\_ ZIP \_\_\_\_\_

**SEND NOW!  
 \$ SAVE \$**

NEW CLOSE-OUTS AND USED EQUIP. OUR LIST INCLUDES RECEIVERS, TRANSMITTERS, SERVOS, ENGINES, ETC. ALSO TIPS AND NEWS ITEMS. START RECEIVING YOURS NOW. SEND ONLY 10¢.

**TRADE UP TO MULTI!**

WE WILL SAVE YOU AT LEAST 25% OF THE PRICE OF MOST NEW EQUIPMENT YOU BUY IF YOU TRADE IN YOUR USED MODEL EQUIPMENT. WE WILL TAKE ENGINES IN TRADE FOR RADIO EQUIPMENT AND VICE VERSA. WE WILL ACCEPT NO MORE THAN ONE USED UNIT FOR EACH NEW UNIT. SEND US A CARD STATING WHAT YOU WANT AND WHAT YOU HAVE TO TRADE. SORRY, NO TRADE-INS ON SALE ITEMS, USED EQUIPMENT OR CLOSEOUTS.

## Bonner Digimite

(Continued from Page 52)

Magazine for testing the Bonner Digimite Proportional system was the 1964 Nat's winning Candy design by Cliff Weirick, utilizing a GlasKraft fiberglass fuselage and Meinke Model Engineering pre-made wing, and a Kwik-Fli constructed in the conventional manner from RCM plans.

The first flight of the Candy terminated in a somewhat rougher than normal landing, knocking the entire landing gear assembly out of the wing. This gear assembly, with hardwood bearers, was found to have been only tack cemented in place with standard model cements. Although we understand from the manufacturer of these wings that this practice has been corrected, we suggest that you check the mounting of your landing gear when using this make of wing. Following this first flight, the airplane was slightly out of trim, but the trim levers were so arranged that in-flight trim was easily accomplished. Over fifty flights on the two airplanes were completed without incident, with the possible exception of two "fail-safes"

on the Candy, probably due to heavy field use. This is a good sign, certainly showing the fail-safe feature on the system as operational. Both test pilots evidenced an ease in acclimating themselves to the "single stick" configuration (prime controls) and found it to be as equally good as separated sticks. This, then, is simply a matter of operator preference.

The findings of RCM can best be expressed in the tape-recorded statements of both test pilots at the conclusion of a month of flight tests:

Frank Justin: "The Bonner Digimite gear is more than adequate for proportional flying. The level of construction is good. The attitude of the manufacturer towards the consumer is excellent. I would not hesitate to recommend this system to any modeler. I personally don't care for the number of components used, which makes for a higher system failure potential, but in order to obtain eight channels of control, a lesser number of components is not logical. I feel, personally, that I do not need eight channels of control, and that six would be adequate. The manufacturer's intention here is to give the most control availability for the dollar. I don't think that there are specific features

on this system that make it worth more to me as a modeler than previous systems have tested, and available at a slightly lower cost. However, based on previous experience with Bonner products, should any problems evolve with the Digimite system, they would be immediately rectified, and the equipment would be modified (within reason) with any changes introduced by the manufacturer.

Chuck Waas: "The Bonner Digimite system represents, for me, the best all around system, both in stick function and reliability of equipment that is available today. I feel, and have felt, completely at ease through all maneuvers — a feeling that I have never fully realized during many years of reed flying in a variety of aircraft. I am, of course, sold on proportional, and have complete confidence in Howard Bonner's new system."

This, then, is the Bonner Digimite Proportional system — an eight channel system priced at \$615 and currently in full production. A system that is soundly engineered, well-built, with excellent control response, and seemingly completely reliable. It is recommended by RCM and rated number one of the four systems tested to date.



# YOU DESIGNED IT!

## THE NEW MAMBO SPECIAL

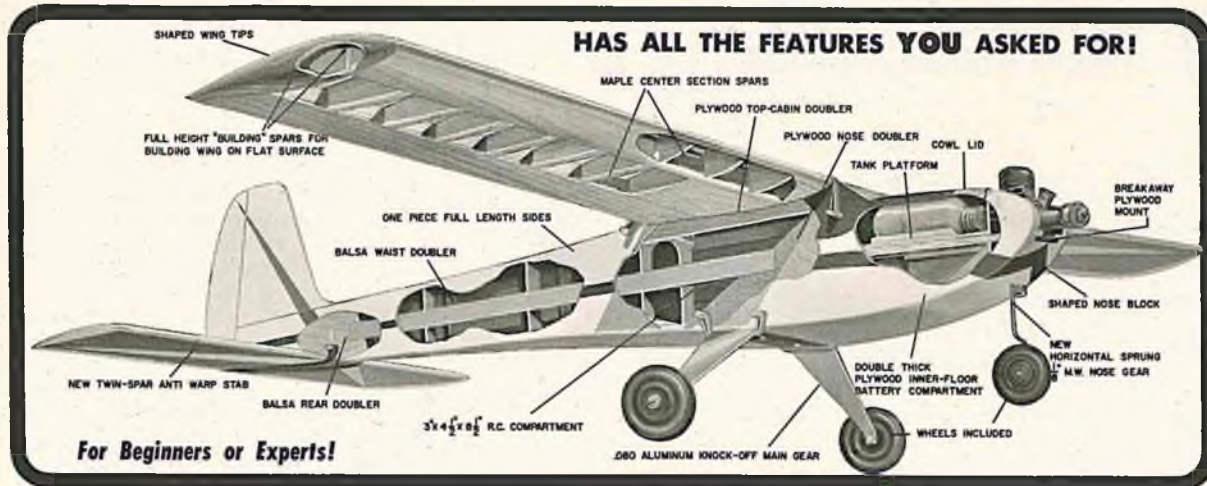

Takes Single to 6 Channel!  
You don't have to be a magician to install even 6-channel equipment in the big roomy fuselage compartment.

### MAMBO SPECIAL

Kit FS-16  
Span—52"  
1 to 6 channel R/C

\$11.95

### SLEEKER! ROOMIER! STRONGER! THE MOST RESPONSIVE FLYER YOU EVER CONTROLLED!

This is every model builder's DREAM MAMBO! It includes every feature that you would put into a plane of your own design—and the result is THE MOST REFINED MAMBO DESIGN EVER—A SENSATIONAL 52" BEAUTY!

And *What a flyer!* If you're just beginning to discover how great R/C flying can be, the "SPECIAL" is *your kitten*. So gentle... so forgiving... and oh, so easy to fly! *But*—if you can really handle the stick... just add the horsepower and the channels... and the kitten becomes a *TIGER!* Rugged...

responsive... amazing wind penetration... The "SPECIAL" is the perfect flying partner!

- EXCLUSIVE! HORIZONTAL COIL SPRUNG NOSE GEAR!
- Completely pre-fabbed with all parts cleanly die-cut and/or carved.
- Hardware Pak even includes blind nuts.
- Easy-step-by-step plans show installation of R/C.
- Plenty of room for R/C equipment from single to 6 channel!
- Plans include step-by-step illustrations and full size layouts for the wing, tail and fuselage for easy assembly.

By **Sterling** MODELS  
BELFIELD AVE. & WISTER ST.  
PHILADELPHIA 44, PA.

## Top Out

(Continued from Page 50)

ment performed. It took two flights to check the airplane out and to give Harvey some stick time. On the third flight he ROG'd and landed all by himself while I wasn't looking and couldn't tell him it couldn't be done! Been finding that multi rudder is like that for many new fliers — including Juniors! Directional orientation on reed equipment for the newcomer is simpler to achieve than on escape-ments, so consequently, checkouts are quicker, easier for the novice.

Out in Las Vegas is Harold Ellis, a displaced Okie, who writes on Donrey Advertising stationery that he's making styrofoam core diapers — the flying kind, known by the more staid RC'er as deltas. Harold says he's hopeful of being able to put one together, including equipment, in three days. Knowing Harold, it's possible he'll do it in two! I remember Harold making two halves of a regular wing from scratch in a single hectic evening—only to find out he built two rights! Friend Ellis is one of the sparkplugs of the LVRC club, and along with Reese Jameson, hosted my stay in Vegas during their

October Contest at Henderson Dry Lake. The Ellis workshop is a sight which has to be seen in order that I not be accused of exaggeration! At least two dozen ships up in the rafters or on the bench, and equipment galore everywhere else. With Harold turning them out with a hot wire, he'll need the lobby of the Dunes Hotel to store them where Eddie "Mad Man" Morgan can watch over them! With lots of go, I guess Harold just had to have a lot of projects going.

Incidentally, I read in another magazine, a bi-monthly, in a column called 'Western Roundup,' about the Las Vegas contest. Made good reading and I recommend it... written by a fellow named Rick Everight, I think — sometimes it's hard to get the name right...

We received a couple of letters from Andy Rattinger who RC's down in Guadalajara, Mexico. Andy is kind enough to keep the invitation open to their regular September contest and I keep promising Emily that we'll go one of these years. And we will — also to the Mexico City Nationals when, perhaps, they'll have Class I. Andy is a young college student who is serious

about planes but has limited time now for building and flying. Hope to see him in San Antonio again soon.

A card from Carl Summers reminds us that doings in Dallas have slacked off somewhat after the Nat's and the Southwest Championships. Carl, Dick Huang, and L. V. Johnson were the trio who did such a bang-up job of organizing and managing RC at Dallas last year. The diminished activity is a sort of natural pause since folks do get a mite 'burned out' but Springtime will no doubt change that pace! Carl says that plans for the 1965 Southwest Championships haven't been started as yet. I notice an AMA sanction has been given the TORKS of Oklahoma City for the dates usually taken up by the Dallas group for the Southwest in September. What gives, Dallas? Maybe the RC Clubs League Carl mentions will be helpful in regaining the usual momentum once it is finalized...

... and finally, from the news letter of the Tulsa Glue Dobbbers we learn that about the only way to stop a woman from demanding a fur coat is to pelt her. What other way is there to ease the way for a new ten channel rig?

## Kits and Pieces

(Continued from Page 57)



over the plans, to insure correct alignment. This is indicated on the plans, but at a point where it would be rather difficult to make any corrections. The top and bottom planking have tabs for locating to the fuselage sides (the planking is narrower than the fuselage to save sanding later). Formers #3 and #4 should be used to gauge the width through the cabin area when installing the bottom planking.

The fuselage was completed per the plans. The windshield was left off until after painting (windshield material was warmed with a hair dryer to ease forming around the curves, then held in place with white glue). A sanding gauge is included for use in rounding the fuselage corners. This simple device takes the guesswork out of this operation. (Kit manufacturers, please note!)

The wing construction is quite simple, since it is a flat bottom section. Building the framework on a flat, true surface is a must! It should be noted that the leading edge of the ribs are slanted forward, and care must be taken to insure that the leading edge itself is properly seated on the ribs. A 1/20" thick x 3/8" wide strip is included for shimming the leading edge to the correct height. The wing was assembled per the plans with no difficulty.

The stabilizer went together easily, thanks to an innovation called Symmet-Tru construction, providing a series of tab height gauges to accurately position the leading and trailing edge heights, resulting in a true surface. The tabs are removed after the structure is thoroughly dry. In addition, the small tabs at the leading edge of S-1 must be removed before the center section planking could be installed (planking could have been notched instead).

The struts, as received, were over-

(Continued on next Page)

# ANNCO

## MULTI-SERVOS

FOR RADIO CONTROL SYSTEMS  
OF R/C PLANES • BOATS • CARS

SAVE — NOW DIRECT FROM THE MANUFACTURER!

Look at These Exclusive Features from ANNCO

- ★ WEIGHT — 2R — 1.3 ozs. 2 RL — 1.7 ozs.
- ★ SIZE — 3/4" x 1 1/16" x 1 3/4"
- ★ THRUST — Over Three Pounds.
- ★ TRAVEL — 5/8" Straight Linear.
- ★ TRANSIT TIME—1/2 Sec. from Neutral.
- ★ MOTOR—5 OHM—180 ma no load. Stalls at 600 ma @ 2.4 v.
- ★ BRUSHES—97% Silver Graphite.
- ★ AMPLIFIER — All Model 2RL Servos are equipped with our 7 transistor amplifier (DK-7) that features complete burn out proof operation while adjusting centering, or if adjacent reads are driven at the same time. DK-7 sold separately @ \$11.95 ea. ppd.

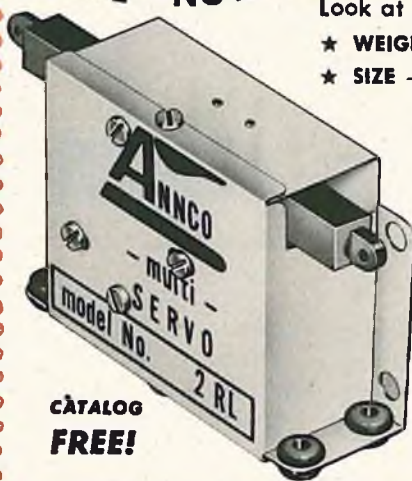

CATALOG  
FREE!

NO. 2R (Relay) . . . . . Only \$7.95 ppd.

NO. 2RL (Relayless) . . . Only \$19.95 ppd.

SELF NEUTRALIZING OR CAN BE SET UP FOR TRIM.

HOW TO  
ORDER....

Orders will be shipped postpaid within the U.S.A. and Canada (except Air Mail add 25¢ each). Foreign Countries — add 50¢ each for regular mail or \$1.50 each Air Mail. SEND YOUR ORDER TODAY!

Dealers, Write on Your Letterhead for Special Set Up....Only Bona Fide Hobby Dealers Accepted.

**ANNCO ENGINEERING CO.** 7714 Colfax Avenue South  
Minneapolis, Minnesota 55423

## WE DON'T SELL OUR SERVICE . . .

## We give it away

Whether you need a quadruple simultaneous proportional outfit, a single channel rig, or a fuel tank, we have what you need, and if you request our "Systems Service" we'll guarantee component compatibility; that is, your transmitter, receiver, servos, etc. are guaranteed compatible with each other to form a true Radio Control System. We have our own preplanned systems too; they're the most complete outfits available anywhere in the world. Find out more about KONAC... just like our service, our Systems Catalogue is straight to the point. We give it away too.

The mail order firm that *knows* radio control . . .  
and puts that knowledge to work for you.

*Konac*

P.O. Box 366

We pay All  
Postage and  
Insurance

RADIO CONTROL SYSTEMS

Vienna, Va.  
22180

# INTRODUCING... KAMPEL SPACE AGE FINISHES

BUTYRATE MODEL AIRCRAFT DOPE

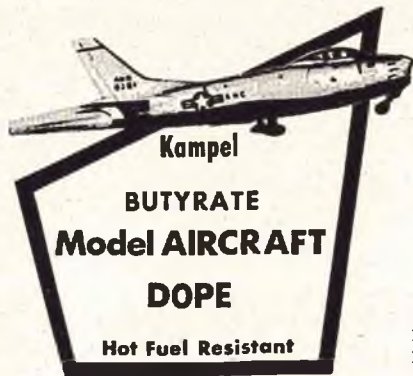

## LOOK AT THESE SUPERIOR QUALITIES

- Plasticizer added to control shrinkage and hardening.
- Heavier body material that permits thinning to facilitate smoother application.
- Attractively priced in quantities not usually available to modelers.
- Adequate pigmentation for superior hiding qualities.

ASK FOR IT AT YOUR NEAREST HOBBY DEALER TODAY

Hobby Dealers  
Inquiries invited }
**Kampe Enterprises, Inc. Dillsburg, Pa., 17019**

length and had to be cut to proper size. They should be exactly ten inches long. (This will be corrected in future production runs). While on the subject, I must add that the method of installing the struts is one of the most clever ideas I have seen. A small piece of vinyl tubing is attached to each end of the strut. The tubing is forced through a slot in the fuselage and one in the wing. The tubing returns to its normal round shape on the inside, firmly holding the strut in place. The joint will, however, slip apart in the event of a hard landing (polite terminology for "crash").

At this point, with all of the structure complete, the wing and stab were covered with silk (silkspan is included with the kit). Care must be taken to pull the covering evenly on both sides of the surface, as the framework is rather flexible, and will easily twist. Cover one side of the surface (top), followed immediately by the other side (bottom), working one panel at a time (left or right). Covering instructions are included on the plans, and are very complete. I chose to cover the fuselage with the silkspan included, as less dope is required with the paper (I was very weight conscious at this point). Should any warps develop in the wing or stab, they can usually be removed by weighting the surface true, then applying a coat of clear dope, or thinner. The wing can be weighted on a flat surface. Allow to dry thoroughly.

The wing and stab were assembled to the fuselage, in order to check their alignment. Careful alignment, combined with true surfaces and accurate balance, assure you that your ship will not be radically different from the original prototype. Many a

novice has given up without realizing the sense of accomplishment to be found in RC, simply because of inattention to these seemingly minor details.

Clear dope was applied as the construction progressed. The wing and stab were left natural, clear dope only. Trim color was added to the fuselage. With the engine (Cox Medallion .049) and wheels installed, the weight was now 15½ ounces — the balance was as indicated on the plans.

I could wait no longer — time for a test glide! You have no doubt read about test gliding procedures — tall grass, reasonably calm, etc. The wind was blowing about fifteen miles per hour as I approached the front street (tall concrete). A gentle toss into the wind and the ship floated to a perfect landing a good 75 feet away. It appeared that the weight I had so carefully watched would not be a problem.

A Min-X Pulsemite 1200 receiver was installed, with an Accutrol Mini-pulse actuator giving proportional rudder and positionable throttle on the .049 mill. The power supply consisted of two alkaline pencils for the receiver, and two ni-cad pencils for the actuator. The receiver batteries were placed in the cabin under the actuator for easy access. All batteries were soldered, as I have encountered difficulty with battery boxes. With this arrangement, the balance point worked out perfectly. With a thorough equipment check, all was ready for that suspenseful first flight.

With a local flying buddy, Bob Wilkinson, we set out for the flying field. The latter was complete with four inches of snow accompanied by about a 12 mile per hour wind! We decided to attempt the test flight anyway. The

engine responded immediately, the rudder and throttle operations were checked, and all was ready. A light toss into the wind, and the ship began a shallow climb with a very gentle left turn. We allowed the model to gain a little altitude before trying the controls. Then a little right trim was added to bring the flight straight. A little right... then a little left... the nose lifted slightly. All responses were smooth, but a slight tendency for the nose to drop in a turn was noticed. The engine quit and the ship floated to a gentle landing.

Before the next flight, a 1/64" shim was added under the leading edge of the stab (up trim), and a washer was added behind the engine to produce a little right thrust. This time the ship went straight as a die, with a little more climbing altitude. The Skylane flew very easily, and should be stable enough for even the newest member of this vast RC fraternity.

After many flights, and one rather severe crash, the Skylane has been found to be unusually rugged. I did find that the tail cone, where the rear stab dowel is located, should be strengthened by wrapping nylon tape around this area. All of the equipment has functioned perfectly. The crash was caused by a dead ni-cad cell in the servo supply, resulting in no damage to the ship's structure.

The CG Skylane builds into an exceptionally good looking, good flying airplane. The kit goes together easily, and all parts fit well. A little extra time is required due to the open cabin structure, but the added appearance makes it well worthwhile. The cabin structure is as strong as any conventional structure. The Skylane kit includes an informative booklet by Carl

# SINGLE CHANNEL OR MULTI - - YOUR BEST BET IS LIVE WIRE!

Wing Span: 66"  
Wing Area: 860 sq. in.  
Wt., Minus R/C: 60 oz.  
Power: .19 to .49 Eng.

## "SONIC Cruiser" Multi-Control R/C Trainer

Man-sized plane that gives peak performance in all maneuvers, for even average flyers! Fly it all out with complete multi equipment or fly it conservatively on single channel with smaller engines. Design uses latest aerodynamic advances including neutral thrust, grooved stability and symmetrical airfoil.

**DELUXE KIT \$19.95**

**New!**  
**Multi-Control R/C Trainer**

Dmecc Kits are completely pre-fabricated, with full size assembly drawings, all hardware and simple-to-follow instructions for assembly, R/C installation and flying procedures. Finest materials available.

## "Super Cub" R/C Scale Model of the Piper Cub!

Easily handles full R/C equipment and gives top performance throughout the world! Can be flown single channel if desired. Yours for maneuverability, wind penetration, automatic stability and simplified, rugged construction.



Wing Span: 56" Wing Area: 600 sq. in.  
Wt., Minus R/C: 34 oz. Power: .15 to .19 Eng.

**PRE FAB KIT Only \$14.95**

**AT ALL HOBBY DEALERS**  
If not available, order direct.  
(Include 25¢ for postage)

**deBOLT MODEL ENGINEERING CO.**  
"Home of Design-Engineered Models"  
3833 HARLEM ROAD BUFFALO 15, N. Y.

**SERVO INFORMATION BOOKLET and CATALOG**  
Post paid . . . 25¢

Goldberg which will be of great value in trimming and initial flying. Take the time to read it!

The Skylane is recommended as a stable rudder-only "fun" airplane, and should be just right for that nearby vacant lot.

Next month we hope to probe into the new foam-and-plywood El Tigre by Woodcraft, and in following months we will look at the VK Cherokee, Aamco "S-Ray" and "H-Ray," plus a host of other new additions to the rapidly growing kit industry. In addition, a "we build" article on the new Dee Bee 21K Quadruplex proportional system is planned — the latter is a kit version of the outstanding Dee Bee "21".

We want to hear from you — send in your questions and comments. If it appears to be worthwhile, we may add a question and answer section. Write to Bernie Murphy, c/o R/C Modeler Magazine, Linthicum, Maryland.

## Flying Proportional

(Continued from Page 14)

wrong, or if the model should be violently out of trim, believe me, the expert will have a thousand percent better chance of shaving it for successive flights. After he has had a couple of flights on the model and has it roughly trimmed so that it will fly straight and level—NOW IT'S YOUR TURN! However, have him take it off and stand by while you fly it all by yourself. Have him continue to stand by until you are familiar enough with the model and ready to fly it on your own.

At this point, a word to that experienced proportional flier. I realize that it is not particular fun to stand by while a beginner learns to fly. However, if you teach that beginner how to do it well enough, then he will be the instructor for that new beginner coming on behind him and you can go on your merry way. I speak from experience.

For those who don't have that experienced flier at the field, I will try, on paper, to successfully get you off the ground and back on — in one piece.

This may sound silly to metropolitan area fliers, but there are places in the United States that have fellows flying all by themselves. To those RC'ers I dedicate the next portion of this article.

First, I suggest that you practice taxiing the model around to familiarize yourself with throttle and rudder control. This also helps to steady the nerves. There is no way to know when you are ready to try your first flight. This will be up to you. When you feel you are as ready as you will ever be, let's try a take off. I recommend on the first attempts to try letting the model go with the throttle wide open. This will help prevent ground loops. Let us now assume that the model is roaring down the runway and it looks like it's going fast enough to fly. Gently pull back on the elevator stick. **Don't** just yank it full back because you will be immediately in trouble. As the model leaves the ground, remember to hold only enough elevator to keep it climbing gently. If the model is

out of trim in a pitch axis, you may have to hold up, or possibly, down elevator. Try to keep the wings level on the climb-out with either aileron or rudder, as the case may be.

After reaching a reasonable altitude, now try to trim the model with the trim controls on the transmitter. I would suggest using reduced power for these initial flights. In other words, don't go roaring around the sky wide open. Everything happens ever so much faster and a beginner doesn't really have time to think.

Let us now assume that you have the model roughly trimmed out and it doesn't seem to be reacting too violently to your gentle control stick movement. Try some gentle turns to the right and to the left and above all, keep the model close enough to you so that you can observe what it is doing. If you fly it somewhere out around the next County, I, for one, am blind enough that if I were there, I couldn't help you. Again, I speak from experience.

If the model is soaring along fine, and you are feeling great — now comes a moment of decision — you must get the model back where it started from.

I hope that your engine idles well because if you goof on your landing approach, it is sure nice to be able to add a little throttle and come around again and have another shot at it. If you have a dead engine — you're committed. Don't try to stretch your glide back to the field, or I should say runway. If you can make it back — fine! If not, set it

(Continued on the next Page)

**NEW ITEMS!**

Special plastic tip, non marking and long lasting



**"CHICKEN STICK" ENGINE STARTER**

- Prevents cut fingers
- Starts engines quicker
- Saves tempers
- Nothing to attach to your fingers
- Great for nylon props
- Stops backward running engines
- Terrific for winter weather starting
- Ideal for youngsters or oldsters
- For all class engines, 1/2A to .60

only 69c ea.

See Your Dealer or Order Direct

Fuel resistant enameled handle



**Cox, Fox, K&B 1/2A Engine Mount \$1.50**

Save time, install this machined aluminum disc and formed landing wire on your next 1/2A.

Neoprene Rubber Discs

Cl. 1/2A	.....25c
Cl. .09-.15	.....30c
Cl. .29-.35	.....35c
Cl. .45-.60	.....35c

These discs are made especially for all Tatone mounts. They provide smoother engine runs, eliminate vibration and allow minor thrust adjustments.

Free Flight or R/C Single Channel



**FIXED-GEAR ENGINE MOUNT**

- Landing gear is fastened directly to engine mount
- Simply bolt engine mount to firewall, attach gear wire whenever convenient
- Eliminates landing gear bulkheads, J-Bolts, saves weight and time
- Double coil gear wire included, absorbs landing and D-T shock

Pat. Pend.

**THREE ENGINE SIZES**

F/F .15	.....\$2.50
F/F .19-.23	.....2.50
F/F .29-.35	.....2.75

Specify engine when ordering

**TATONE PRODUCTS • 1275 GENEVA AVE. • SAN FRANCISCO, CALIF. 94112**

Circle No. 137 on Reader Service Card



## Dee Bee 21 Conversion by ACCUTROL

Now! Dee Bee 21 owners can enjoy Full Feedback Proportional — including Proportional Throttle

Here at last is a complete conversion for the Dee Bee 21 — approved by Don Brown, himself. Conversion is supplied with 4 Accutrol servos, completely wired, on a PC board with electronics, switches, and connectors. All that is required is installation of the throttle pot in the transmitter (2 wires), and installation of connector on your receiver. Your present 21 servo board may still be used in another ship.

**Dee Bee 21 Conversion \$160 Throttle Only \$60**

**ACCUTRONICS ENGINEERING**  
P.O. Box 144      Linthicum, Maryland



### I dreamed I went flying, but crashed on my maiden flight

Lucky me. When I was displaying my latest design, the Trans-Oceanic Traveler, powered by 13 .002 engines mounted inside the fuselage, and having 21 wheels, the clothesline broke. My AMA insurance came in real handy.

"TOT" fell on Clyde Potberry's foot. He is the next-door neighbor I have interested in model building. Clyde joined the AMA, too, after the accident. He figured if it could happen to me, it could happen to him.

Please enter me as a member of the Academy of Model Aeronautics

License classification is based on your age as of July 1, 1965.  
**JUNIOR LICENSE** (including 15 years)  
**SENIOR LICENSE** (16 through 20 inclusive)  
**OPEN LICENSE** (21 years and over)

I enclose \$..... Date of Birth .....

Junior  \$3.00      Senior  \$4.50      Open  \$6.00

Name .....

Street .....

City and State .....

Mail to: **ACADEMY OF MODEL AERONAUTICS**  
 1025 Connecticut Ave.      Washington, D. C. 20036

down as gently as you can in the grass or somewhere in the surrounding territory. Trying to stretch the glide can be nothing short of disastrous. When the airplane stalls, believe me, it falls.

Assuming that your engine keeps running when you throttle back, let us now try an approach and a landing. First, don't fly the airplane directly over the runway and try to turn into the wind at this point. Keep it out away from you and make a nice easy gentle turn to line up into the wind. Again, don't let it get too slow but at the same time, don't let it get too fast. Both cases can be disastrous.

Assuming that the model is gliding at a decent rate of speed, let it settle until it is about — oh say, about a foot off the ground, then ease in up elevator, trying to keep the model from ballooning. If everything goes right and you've got the elevator right, it should set down fairly gently. If your brakes are working, stop as soon as you can but not so violently that the model tries to spin around or turn over.

And now, if you haven't broken a propeller or stopped the engine, let's take that model back to its parking place and do exactly as I did on my first successful flight — RUN IN CIRCLES, SCREAM AND SHOUT! Believe me, I revelled in all my glory!

Now that you have completed at least one successful flight, the thing to do next is practice, practice and practice.

Part II of this article, to be presented next month, will contain tips on fine trimming your airplane and all the help that I can possibly give you concerning flying the AMA contest pattern.

(To be continued)

## Editor's Memo

(Continued from Page 6)

walk are pale by comparison.

During the past five years, the direction of RC has become firmly established. This is an adult pastime. It is likely that it will not only remain so, but become increasingly adult in character. This is not to say that juveniles or young people will be excluded; on the contrary, we welcome them with open arms and hope to see more of them. We will help them, in some cases subsidize them, and in

every way possible, encourage them. However, the fact remains that in the foreseeable future at least, cost alone will make this a continuing adult sport.

All right, a sport of adults; not of kings necessarily, but definitely a sport of adults. Why then operate under a constrictive and shortsighted set of rules based on modeling phases which are less thickly populated with adults? Why the need for builder of the model controversies, when one is dealing with people who couldn't care less who built it? I personally had never built an absolutely true multi fuselage or wing until fiberglass fuses and foam wings came into being. These two items alone have made me a better flier. Presumably, they have done the same for others, or they wouldn't be as popular as they presently are.

Like most people in this hobby, I must make a living for myself and family. Building time is in extremely short supply, and is a very precious commodity. The pressures of the present day have robbed most of us in a similar fashion, or I am indeed misinformed. Frankly, if I can fly at a savings in building time, I will do so, and I am no millionaire.

I don't build my own golf clubs; I don't hack out my own fishing pole anymore, nor knit my own bathing suit, yet I am allowed to participate and compete in these activities unhampered by any such archaic or restrictive rules as those under which we must fly an RC ship.

American adults are a very fractious and independent group of people. They choose hobbies and pursue them in a relentless and ferocious manner. When they are presented with rules which have no relation to the actual situation, they merely continue their hobby outside the rules in question. In the case of RC, this means decreased contest attendance, decreased Academy membership and an absolute burgeoning of sport and non-sanctioned contest activity. In our own area this past year, non-sanctioned meets outnumbered sanctioned ones three to one. At a time when we should be increasing AMA prestige and respect for the coming frequency and flying site battles, we are seeing the reverse take place.

Please, let us support our national organization to the fullest extent possible, but at the same time, let us reassert our identity and request workable, knowledgeable rules to govern us.

## QUALITY R/C ACCESSORIES by DU-BRO

### Du-Bro LINKAGE ARM

(FOR BONNER SERVOS)  
Ideal set-up for nose wheel and rudder or engine control where less throw is needed. .050 steel.

only **49¢**  
Stock No. LA-3

### Du-Bro DUAL TAKE-OFF

FOR BONNER SERVOS

only **49¢**  
With a Du-Bro DURA-V-LINK it makes an ideal hook-up for dual or single take-offs. take-off from either end of servo. Brass.

Stock No. DT-4

### Du-Bro DURA-CONNECTOR & V-LINK

For proportional sets using disc servos

only **98¢**  
Stock No. DCL-2

### Du-Bro DURA-V-LINK

CLOSE-UP OF CLEVIS

only **49¢**  
For use with Du-Bro DURA-CONNECTORS and Du-Bro DUAL TAKE-OFFS. Also ideal for other servos with eyelet style take-offs. Spring steel. Stock No. DVL-1

### Du-Bro DURA-COLLARS

1/16" DC116    3/32" DC332    1/8" DC180    5/32" DC332    3/16" DC316

Best collars available. Pugged cadmium plated brass. Threads will not strip. Complete with set screws and Allen wrench. -stronger than aluminum type.

4 FOR **59¢**

### Du-Bro DURA-LINK GUARDS

For those who feel the necessity... a removable safety guard to "positive lock" all links.

4 FOR **10¢**    Stock No. LG-10

### Du-Bro TB-2-TRIM BAR

FOR BONNER SERVOS

Can be modified to Ancco servos. Designed for inline or side by side hook-up. Lightweight.

**\$1.95**

### The ORIGINAL Du-Bro KWIK-LINK

CONTROL YOKE ASSEMBLY  
... for any control linkage!  
THE TOP QUALITY LINK

Split Coupling Sleeve  
3/4" thread on 4" rod  
Stock No. KL-49  
MADE IN THE U.S.A.  
**49¢**

### Du-Bro 6 SPOKE DURA-HUB WHEELS

Permanently pneumatic stronger unbreakable

2 1/4" (1 3/4 oz.)	-\$2.59
2 1/2" (2 oz.)	- 2.79
2 3/4" (2 1/2 oz.)	- 2.99
3" (3 oz.)	- 3.19
3 1/4" (3 1/2 oz.)	- 3.39
3 1/2" (4 oz.)	- 3.59

### Du-Bro POSITIVE ACTION WHEEL BRAKES

1/2 oz. each. Steel brake drum eliminates scoring. Spring steel control arm.

only **\$7.95** pair  
WHEELS NOT INCLUDED

### SERVO MOUNTING HARDWARE PACK

BOLT (3-48)  
WASHER  
SPACER  
BLIND MOUNTING NUT

SINGLE PACK **55¢**  
Hardware for one servo. Stock No. SM 55. Packaged 12 to card

FIVE PACK **\$2.39**  
Hardware for five servos. Stock No. SM 239. Packaged 3 to a card

### Du-Bro BLIND MOUNTING NUTS

Can be used on 1/8" plywood (without sticking thru) and thicker. 4 per pkg. 3 thread sizes:

2-56 Stock No. BN256  
3-48 Stock No. BN348  
4-40 Stock No. BN440

4 EACH **20¢**

NEW 12" KWIK-LINK (12" rod)

DU-BRO PRODUCTS • 7667 Milwaukee Avenue • Niles, Illinois 60648

## FOR LIMITED TIME ONLY

# NEW O & R COMPACT III 1 H.P. ENGINE

AND CAST ALUMINUM MOTOR MOUNT FOR ONLY **\$52.00** PP

and receive **FREE** of extra cost full-size templates, 1/3 size plans and instructions for **WHITE HEAT X** trophy winning Hydroplane

Beam 16"  
Length 42"  
Plywood and Balsa Construction

8148 No. Milwaukee  
Niles, Illinois 60648

**OCTURA MODELS**

FOR BETTER R/C MODEL BOATING  
HURRY—OFFER GOOD ONLY TO AUG. 1, 1965