

# Model Motors 1940

AIRPLANE • MARINE • RACE CAR

# FOREWORD

● We believe this catalog fills a long-felt want among model fans. As your local dealer and source of all model supplies, we are happy to present this compact and beautifully illustrated guide for buyers.

● This issue has been compiled without any wish to suggest a particular motor for your use, but rather, to provide in handy and useful form, information regarding standard types of model motors now available. It is truly a 1940 catalog because some of the motors shown have just been announced by the manufacturers.

● We are prepared to serve all your needs in this fastest growing of America's hobbies. Our stock of motors and accessories is adequate, and we shall be glad to extend any required help in the designing and building of your model airplane, marine or race car. Come in and see us, you are always welcome.

## TABLE OF CONTENTS

Atom .....	Page 2
Brown "B" .....	Page 3
Brown "D" Inverted .....	Page 4
Brownie "E" .....	Page 5
Bunch Speedway .....	Page 6
Dennymite Standard .....	Page 7
Elf .....	Page 8
Factory Specifications .....	Pages 26-27
Foreword .....	Page 1
Forster Marine .....	Page 9
Herkimer "O.K." Special .....	Page 10
Herkimer "O.K." Twin .....	Page 11
Hi-Speed Bullet .....	Page 12
Hi-Speed Torpedo .....	Page 13
Hurleman Aristocrat .....	Page 14
Husky "J.V." .....	Page 15
M and M .....	Page 16
Madewell .....	Page 17
Motor Accessories .....	Pages 28-29
Ohlsson Gold Seal .....	Page 18
Ohlsson-19 .....	Page 19
Ohlsson-23 .....	Page 20
Ohlsson-60 .....	Page 21
Sky Chief .....	Page 22
Syncro Ace Special .....	Page 23
Syncro Bee .....	Page 24
Super Cyclone "G" .....	Page 25

# ATOM

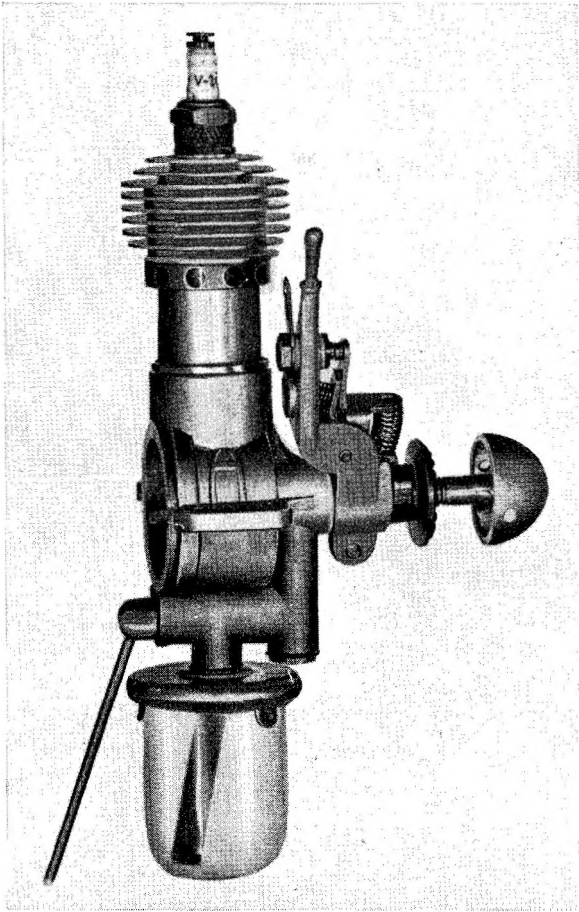

## SPECIFICATIONS

Horsepower—1/10  
Bore 1/2"  
No Piston Rings  
Weight 2 Ozs.

Displacement .097 Cu. In.  
Stroke 1/2"  
Class A  
List Price, \$12.50

The accessories shown on the above motor are standard equipment. Replacement accessories are listed on pages 28-29.

# BROWN B

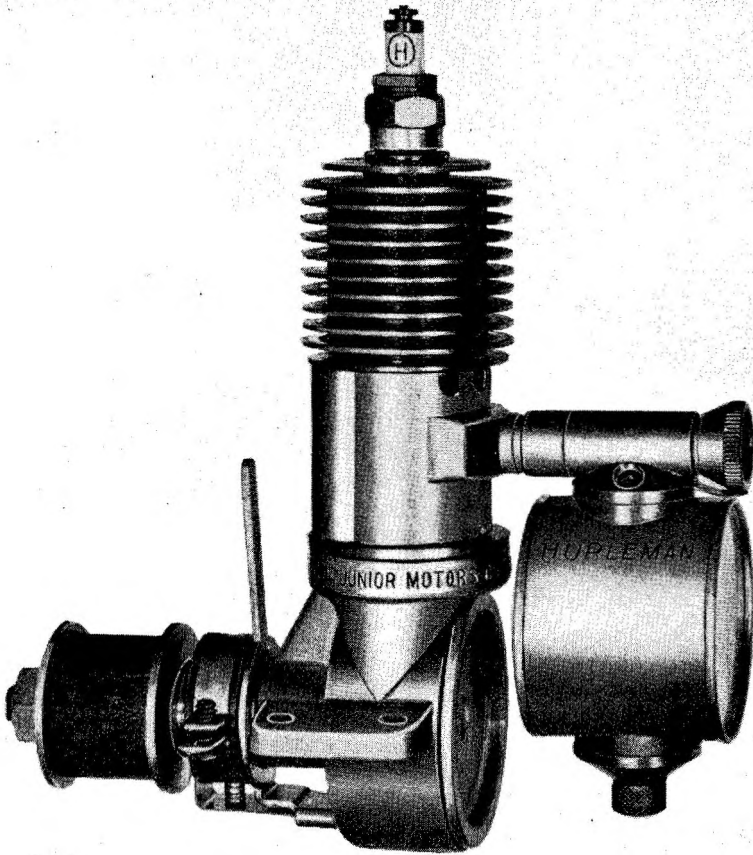

## SPECIFICATIONS

Horsepower—1/5  
Bore 7/8"  
Piston Rings  
Weight 6 1/2 Ozs.

Displacement .6 Cu. In.  
Stroke 1"  
Class C  
List Price \$21.50

The above motor is shown equipped with a Hurleman 3/4 oz. metal carburetor and 2-piece Circle H spark plug.

These accessories are not standard equipment, but may be obtained from your local dealer.

# BROWN D INVERTED

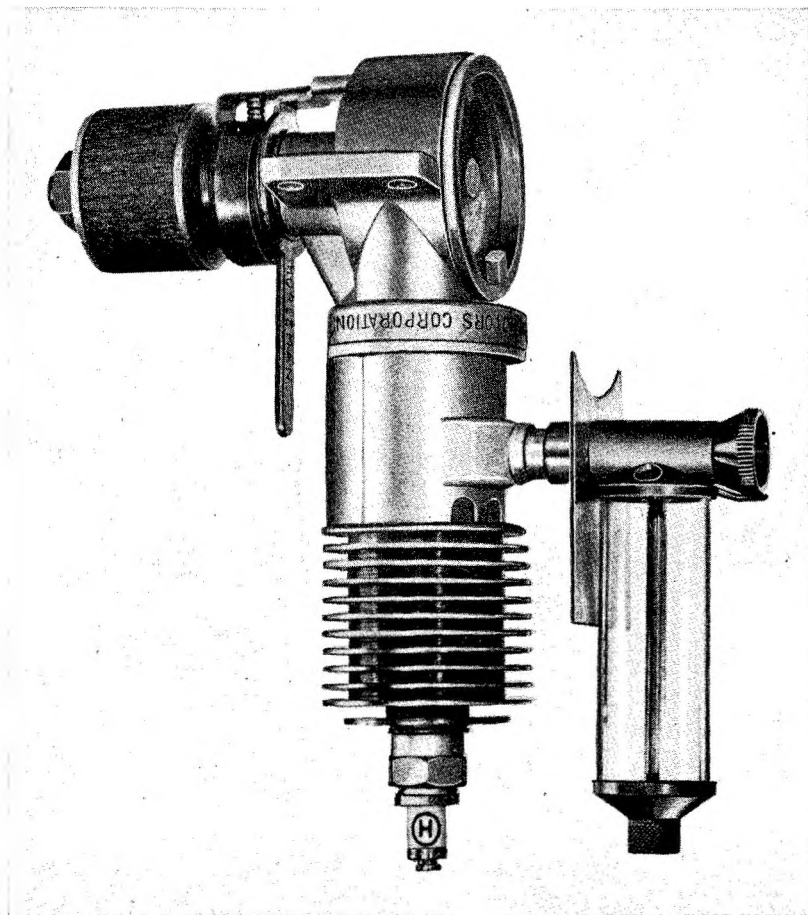

## SPECIFICATIONS

Horsepower—1/5  
Bore  $\frac{7}{8}$ "  
Piston Rings  
Weight  $6\frac{1}{2}$  Ozs.

Displacement .6 Cu. In.  
Stroke 1"  
Class C  
List Price \$12.50

The above motor is shown equipped with a Hurlman  $\frac{1}{4}$  oz. glass carburetor, 2-piece Circle H spark plug and Hurlman ignition timer.

These accessories are not standard equipment, but may be obtained from your local dealer.

# BROWNIE - E

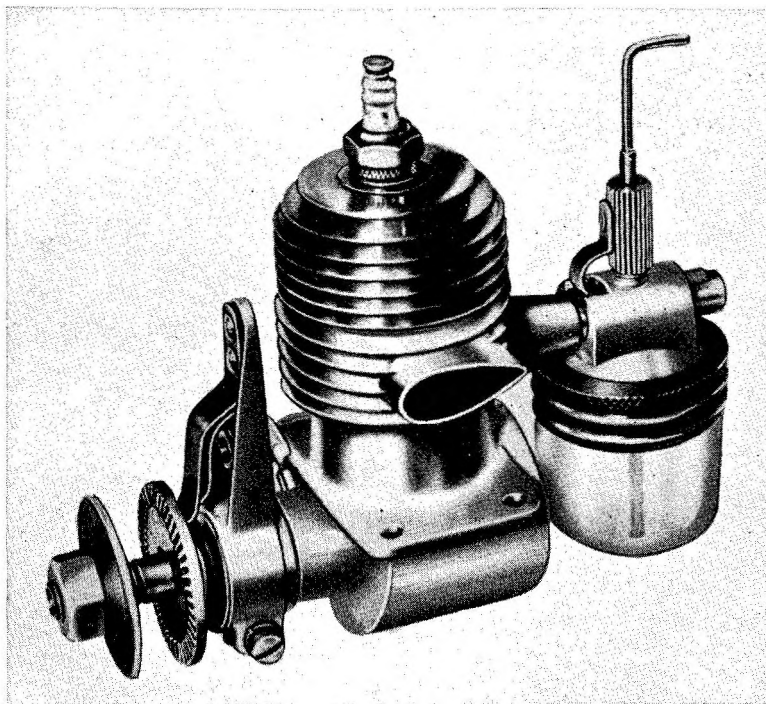

## SPECIFICATIONS

Horsepower—1/7

Bore .770"

Piston Rings

Weight 6½ Ozs.

Displacement .29 Cu. In.

Stroke 5/8"

Class B

List Price, \$7.50

The accessories shown on the above motor are standard equipment. Replacement accessories are listed on pages 28-29.

# BUNCH SPEEDWAY

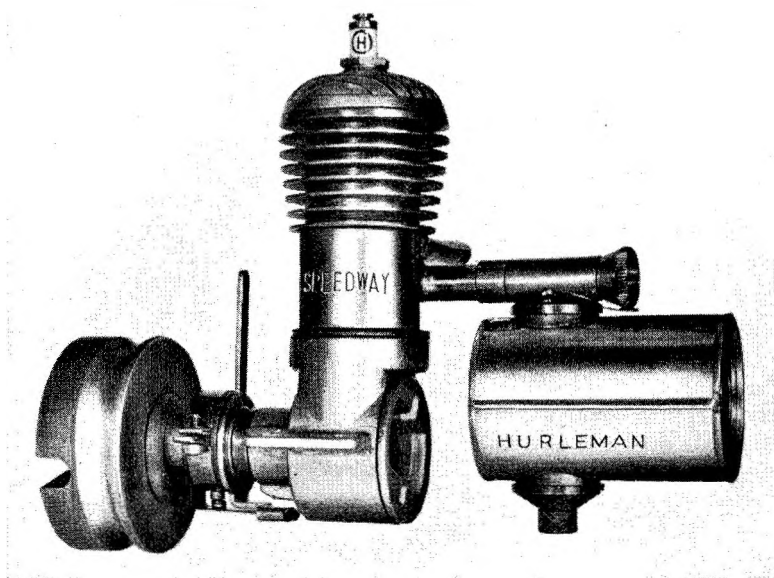

## SPECIFICATIONS

Horsepower—1/5

Bore 7/8"

Piston Rings

Weight 6½ Ozs.

Displacement .45 Cu. In.

Stroke 3/4"

Class C

List Price \$14.00

The above motor is shown equipped with a Hurleman 1¼ oz. metal carburetor and 2-piece Circle H spark plug.

These accessories are not standard equipment, but may be obtained from your local dealer.



# DENNYMITE STANDARD

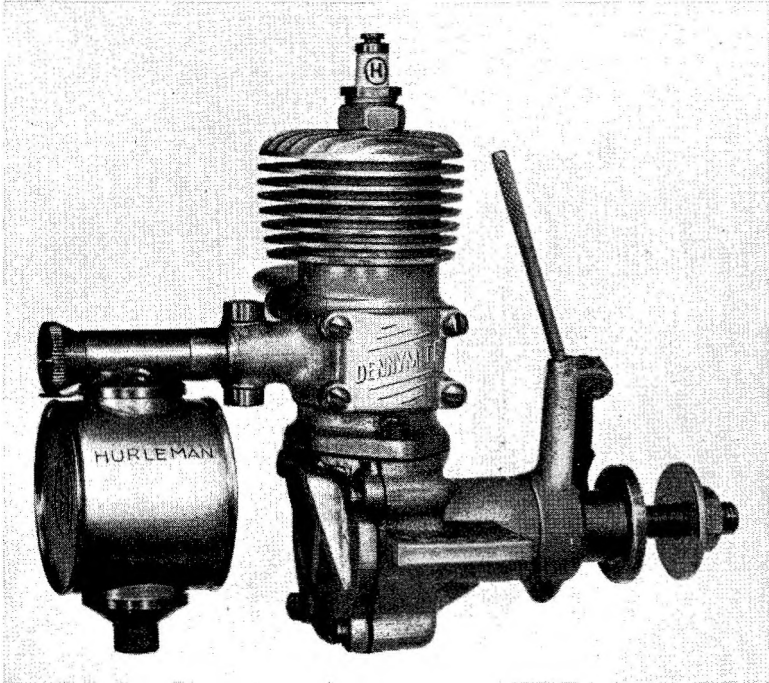

## SPECIFICATIONS

Horsepower— $\frac{1}{4}$   
Bore  $\frac{9}{10}$ "  
No Piston Rings  
Weight 10 Ozs.

Displacement .563 Cu. In.  
Stroke  $\frac{9}{10}$ "  
Class C  
List Price \$15.85

The above motor is shown equipped with a Hurleman  $\frac{3}{4}$  oz. metal carburetor and 2-piece Circle H spark plug.

These accessories are not standard equipment, but may be obtained from your local dealer.

# ELF

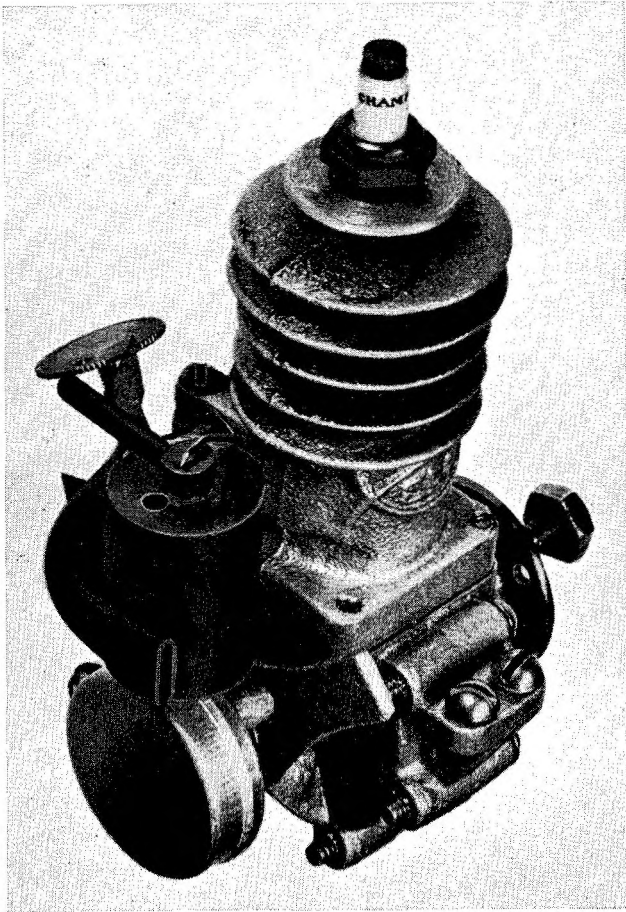

## SPECIFICATIONS

Horsepower—1/30  
Bore .545"  
Piston Rings  
Weight 4 Ozs.

Displacement .138 Cu. In.  
Stroke 19/32"  
Class A  
List Price, \$21.50

**The accessories shown on the above motor are standard equipment. Replacement accessories are listed on pages 28-29.**

# FORSTER MARINE

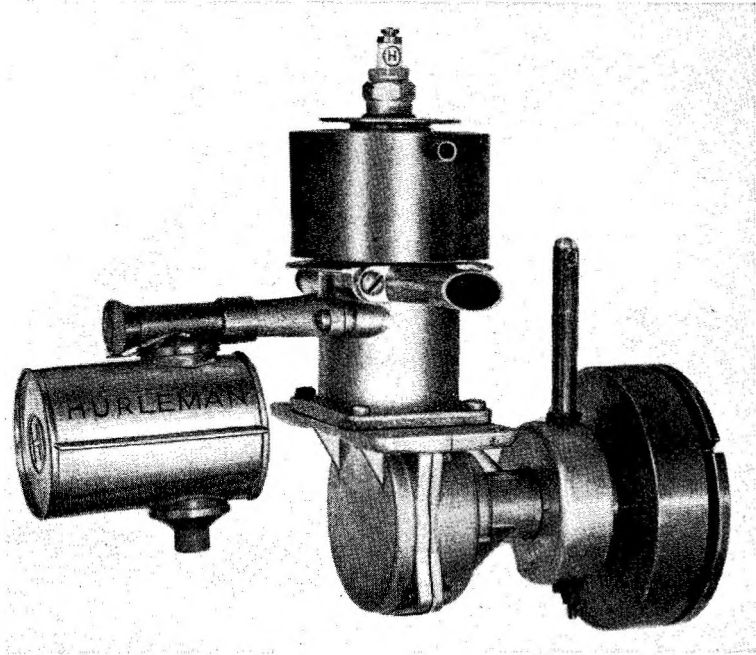

## SPECIFICATIONS

Horsepower—1/3

Bore  $1\frac{1}{16}$ "

Piston Rings

Weight 14 Ozs.

Displacement .997 Cu. In.

Stroke  $1\frac{1}{8}$ "

Class C

List Price, \$27.00

The above motor is shown equipped with a Hurleman  $1\frac{1}{4}$  oz. metal carburetor and 2-piece Circle H spark plug.

These accessories are not standard equipment, but may be obtained from your local dealer.

# Herkimer O. K. Special

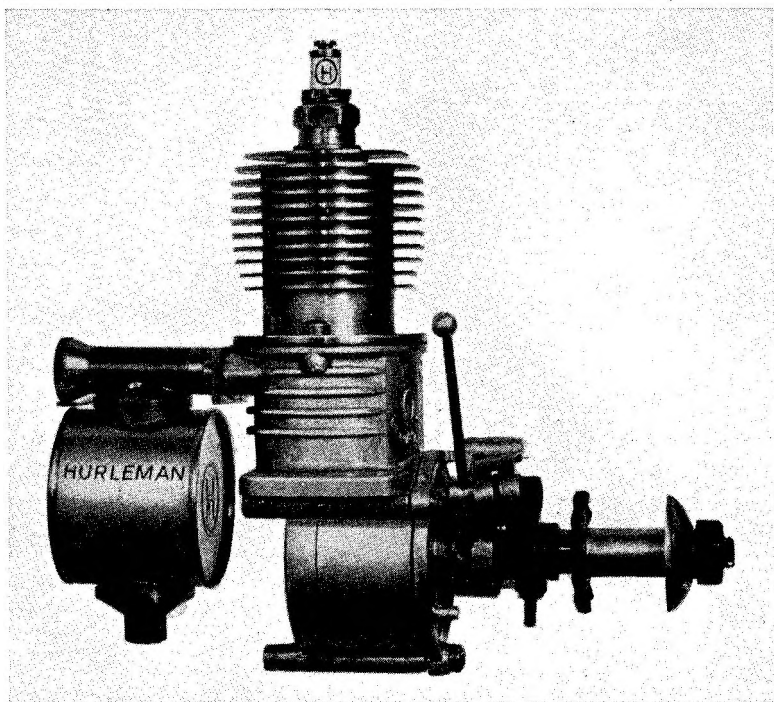

## SPECIFICATIONS

Horsepower—1/5

Bore .900"

No Piston Rings

Weight 7<sup>3</sup>/<sub>4</sub> Ozs.

Displacement .900 Cu. In.

Stroke 31/32"

Class C

List Price, \$11.80

The above motor is shown equipped with a Hurleman <sup>3</sup>/<sub>4</sub> oz. metal carburetor and 2-piece Circle H spark plug.

These accessories are not standard equipment, but may be obtained from your local dealer.

# HERKIMER O. K. TWIN

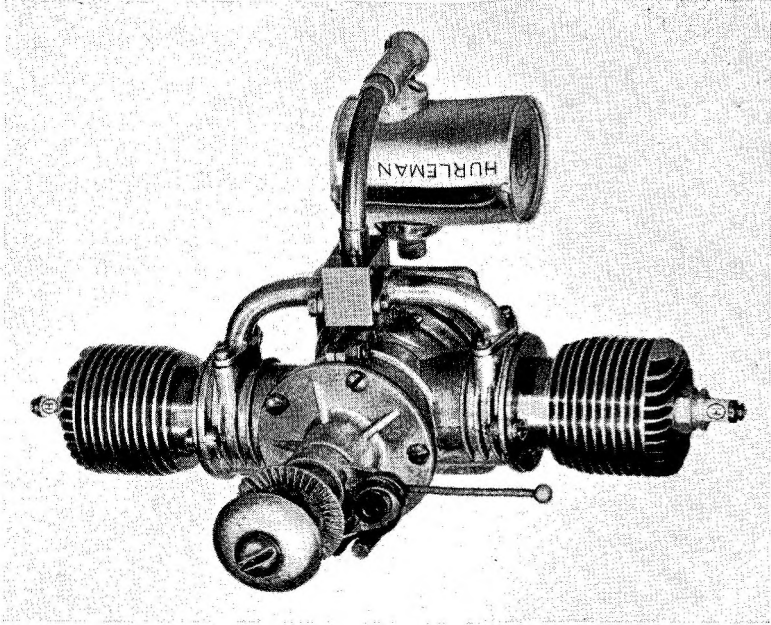

## SPECIFICATIONS

Horsepower— $\frac{1}{2}$   
Bore .900  
No Piston Rings  
Weight 8 Ozs.

Displacement 1.21 Cu. Ins.  
Stroke .950"  
Class C  
List Price \$35.00

The above motor is shown equipped with a Hurleman  $\frac{1}{4}$  oz. metal carburetor and two 2-piece Circle H spark plugs.

These accessories are not standard equipment, but may be obtained from your local dealer.

# HI-SPEED BULLET

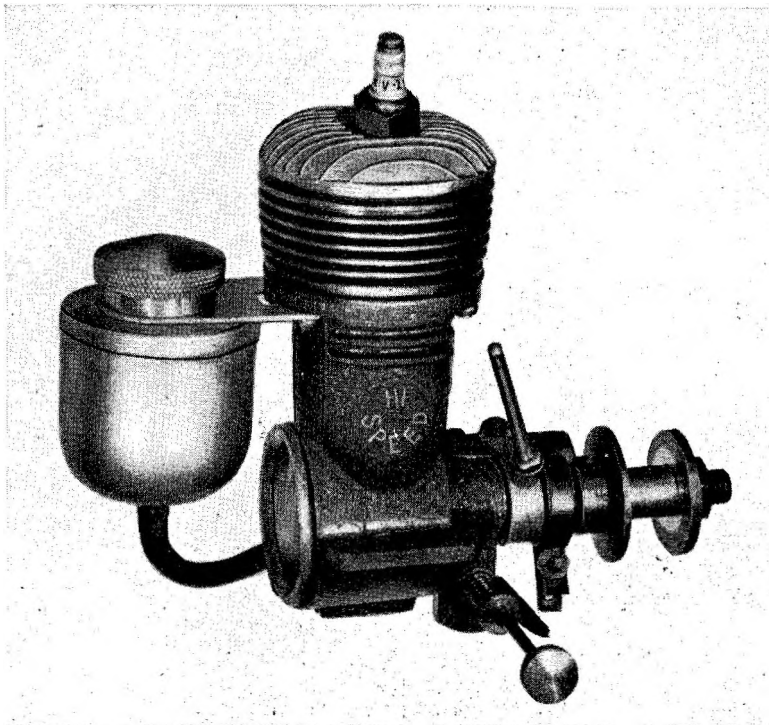

## SPECIFICATIONS

Horsepower—1/7  
Bore  $\frac{5}{8}$ "  
No Piston Rings  
Weight

Displacement .27 Cu. In.  
Stroke  $\frac{5}{8}$ "  
Class B  
List Price \$12.75

The accessories shown on the above motor are standard equipment. Replacement accessories are listed on pages 28-29.

# HI-SPEED TORPEDO

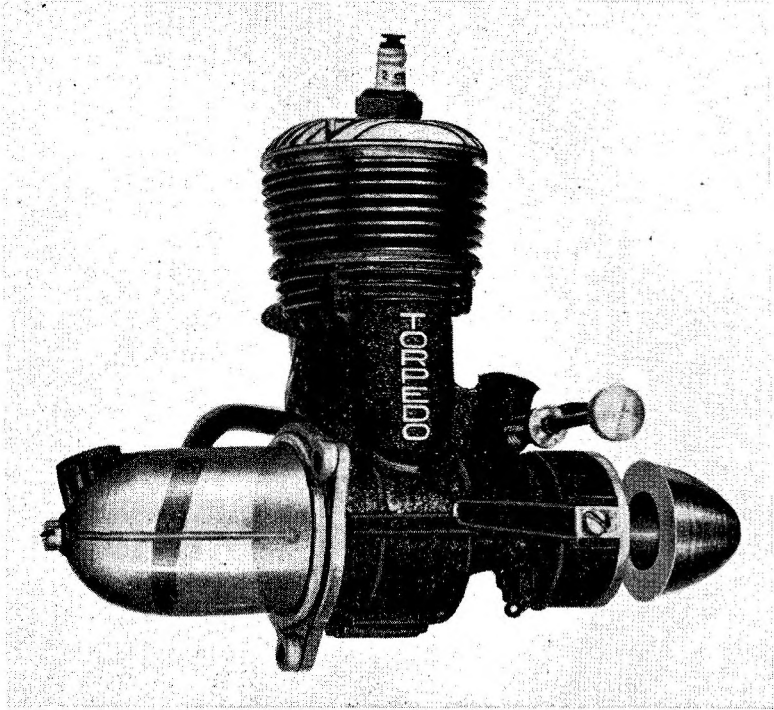

## SPECIFICATIONS

Horsepower—1/6  
Bore 3/4"  
No Piston Rings  
Weight 4 3/4 Ozs.

Displacement .30 Cu. In.  
Stroke 11/16"  
Class B  
List Price, \$16.50

**The accessories shown on the above motor are standard equipment. Replacement accessories are listed on pages 28-29.**

# Hurleman Aristocrat

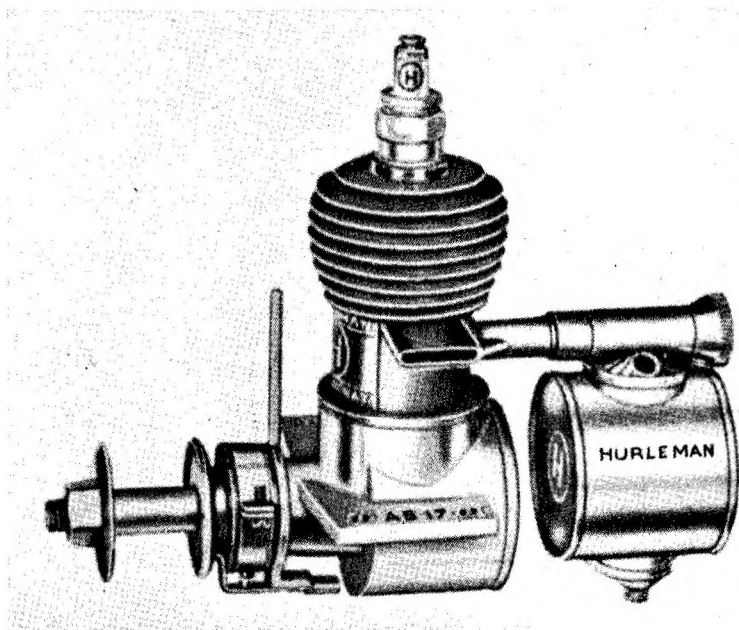

## SPECIFICATIONS

Horsepower—1/5  
Bore 7/8"  
No Piston Rings  
Weight 6½ Ozs.

Displacement .488 Cu. In.  
Stroke 13/16"  
Class C  
List Price, \$21.50

The above motor is shown equipped with a Hurleman ¾ oz. metal carburetor, 2-piece Circle H spark plug and Hurleman ignition timer.

The accessories shown on the above motor are standard equipment. Replacement accessories are listed on pages 28-29.



# HUSKY "J. V."

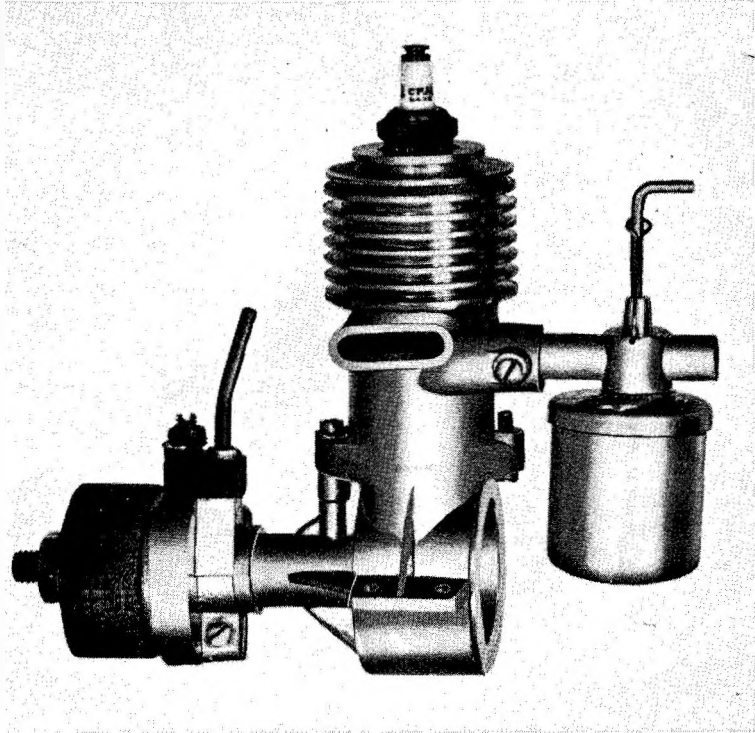

## SPECIFICATIONS

Horsepower— $\frac{1}{8}$   
Bore  $\frac{5}{8}$ "  
No Piston Rings  
Weight  $2\frac{3}{4}$  Ozs.

Displacement .192 Cu. In.  
Stroke  $\frac{5}{8}$ "  
Class A  
List Price \$12.50

**The accessories shown on the above motor are standard equipment. Replacement accessories are listed on pages 28-29.**

# M and M

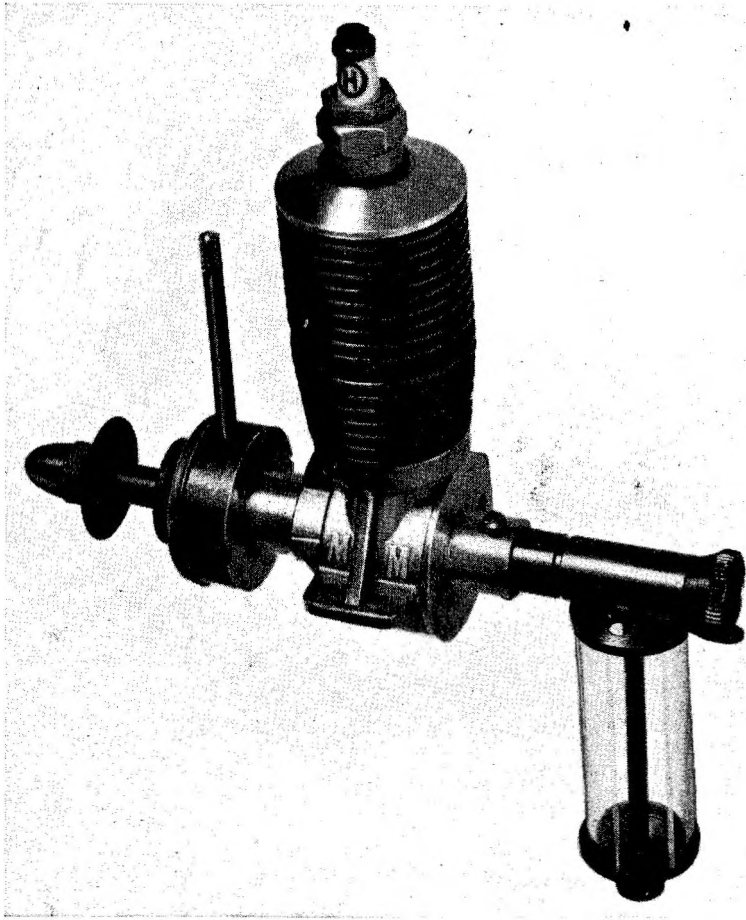

## SPECIFICATIONS

Horsepower—1/7  
Bore 23/32"  
No Piston Rings  
Weight 4½ Ozs.

Displacement .292 Cu. In.  
Stroke 23/32"  
Class B  
List Price, \$16.50

The above motor is shown equipped with a Hurleman ¼ oz. glass carburetor and 2-piece Circle H spark plug.

These accessories are not standard equipment, but may be obtained from your local dealer.

# MADEWELL

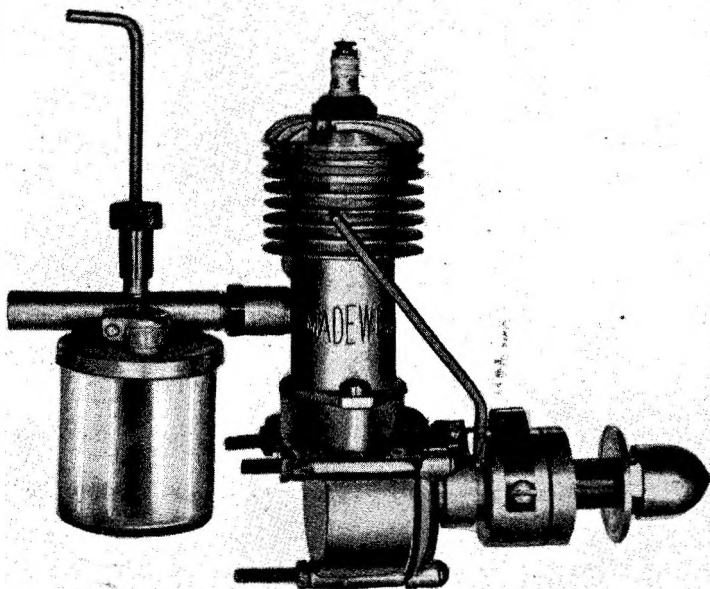

## SPECIFICATIONS

Horsepower

Bore

Piston Rings

Weight

Displacement

Stroke

Class A

List Price, \$12.50

The accessories shown on the above motor are standard equipment. Replacement accessories are listed on pages 28-29.

# OHLSSON GOLD SEAL

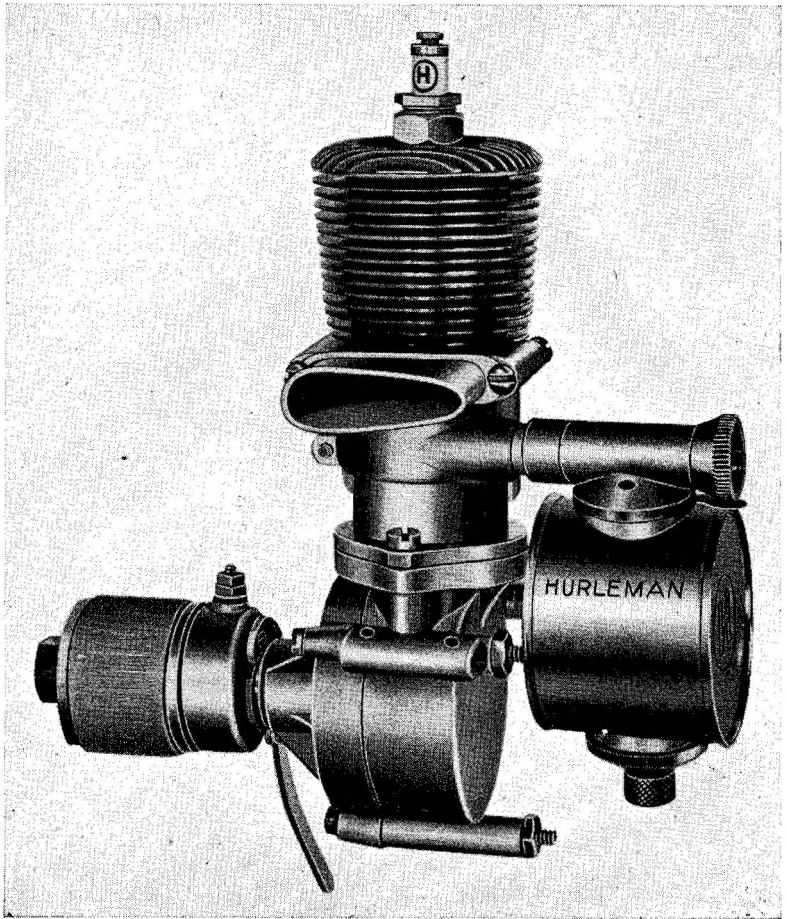

## SPECIFICATIONS

Horsepower— $\frac{1}{5}$   
Bore  $\frac{7}{8}$ "  
No Piston Rings  
Weight 8 Ozs.

Displacement .56 Cu. In.  
Stroke  $\frac{15}{16}$ "  
Class "C"  
List Price, \$18.50

The above motor is shown equipped with a Hurleman  $\frac{3}{4}$  oz. metal carburetor and 2-piece Circle H spark plug.

These accessories are not standard equipment, but may be obtained from your local dealer.

# OHLSSON - 19

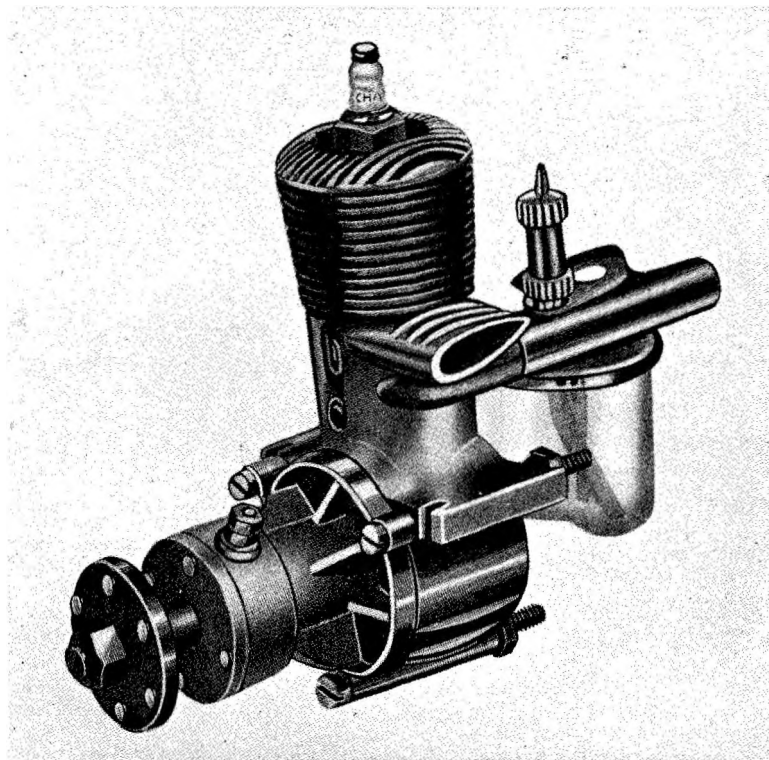

## SPECIFICATIONS

Horsepower—1/7  
Bore 5/8"  
No Piston Rings  
Weight

Displacement .031 Cu. In.  
Stroke 5/8"  
Class A  
List Price, \$14.50

**The accessories shown on the above motor are standard equipment. Replacement accessories are listed on pages 28-29.**

# OHLSSON 23

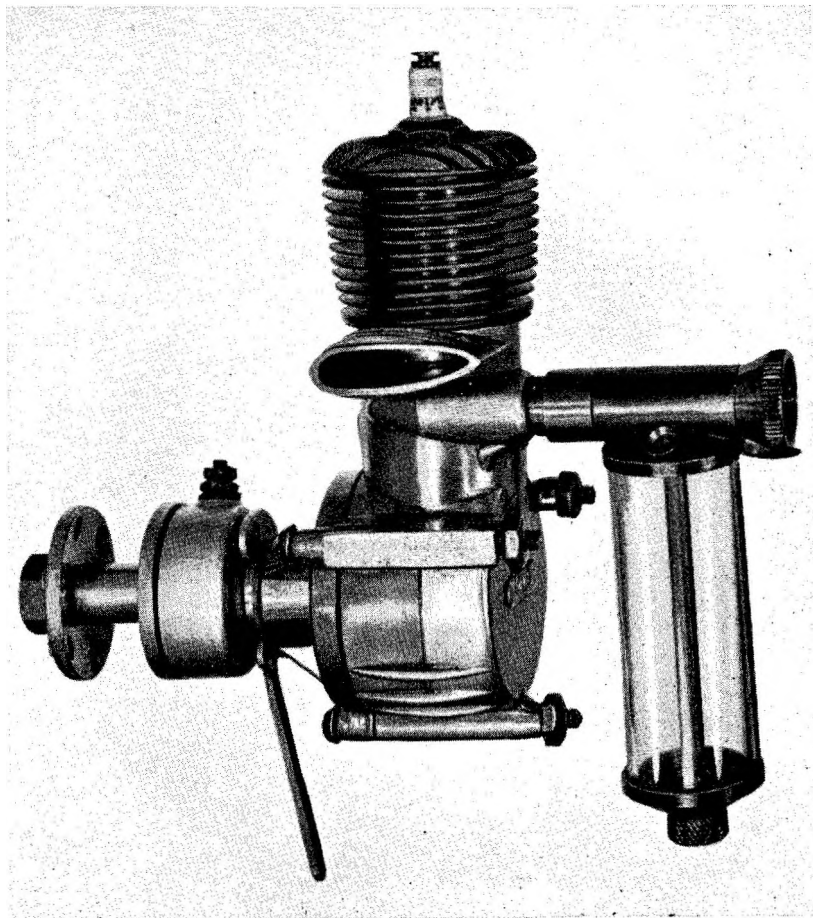

## SPECIFICATIONS

Horsepower—1/7  
Bore 7/8"  
No Piston Rings  
Weight 4 Ozs.

Displacement .213 Cu. In.  
Stroke 1/8"  
Class B  
List Price \$16.50

The above motor is shown with a Hurlman 1/4 oz. glass carburetor.  
This accessory is not standard equipment, but may be obtained from your local dealer.

# OHLSSON - 60

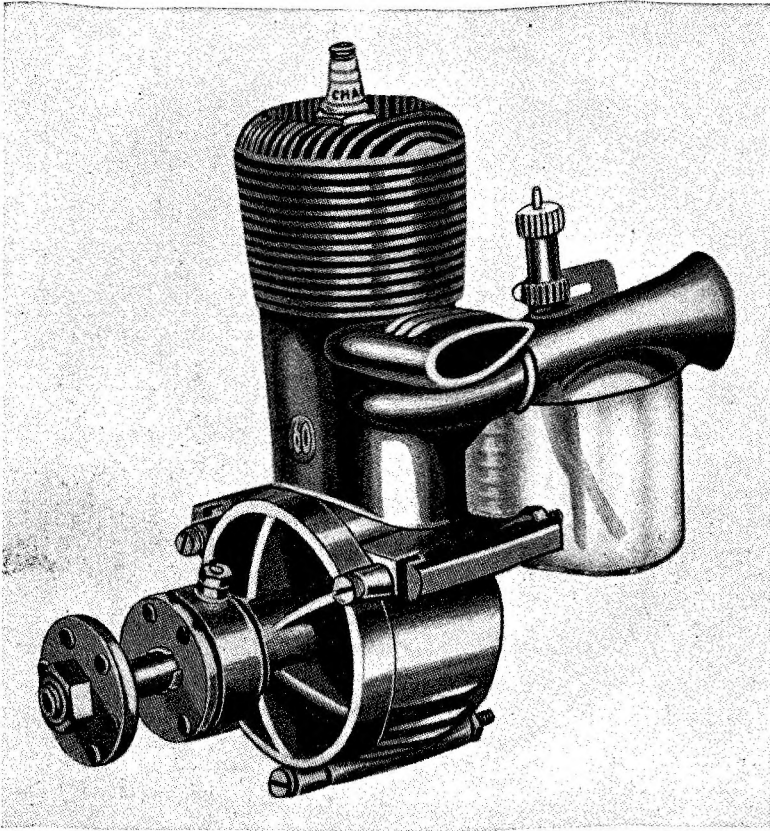

## SPECIFICATIONS

Horsepower—1/5  
Bore  $1\frac{1}{8}$ "  
No Piston Rings  
Weight

Displacement .60 Cu. In.  
Stroke  $\frac{7}{8}$ "  
Class C  
List Price, \$21.50

The accessories shown on the above motor are standard equipment. Replacement accessories are listed on pages 28-29.

# SKY CHIEF

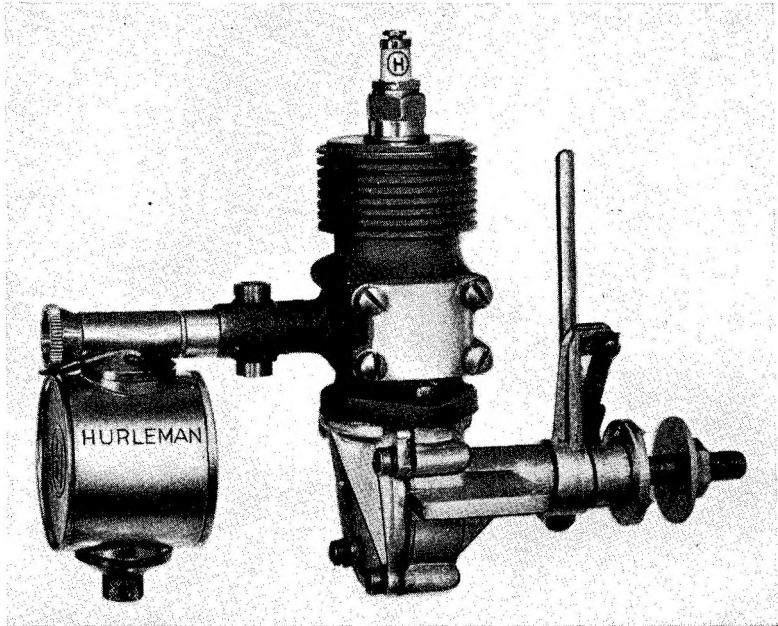

## SPECIFICATIONS

Horsepower

Bore  $\frac{7}{8}$ "

No Piston Rings

Weight

Displacement .526 Cu. In.

Stroke  $\frac{7}{8}$ "

Class C

List Price \$6.95

The above motor is shown equipped with a Hurleman  $\frac{3}{4}$  oz. metal carburetor and 2-piece Circle H spark plug.

These accessories are not standard equipment, but may be obtained from your local dealer.



# SYNCR0 ACE SPECIAL

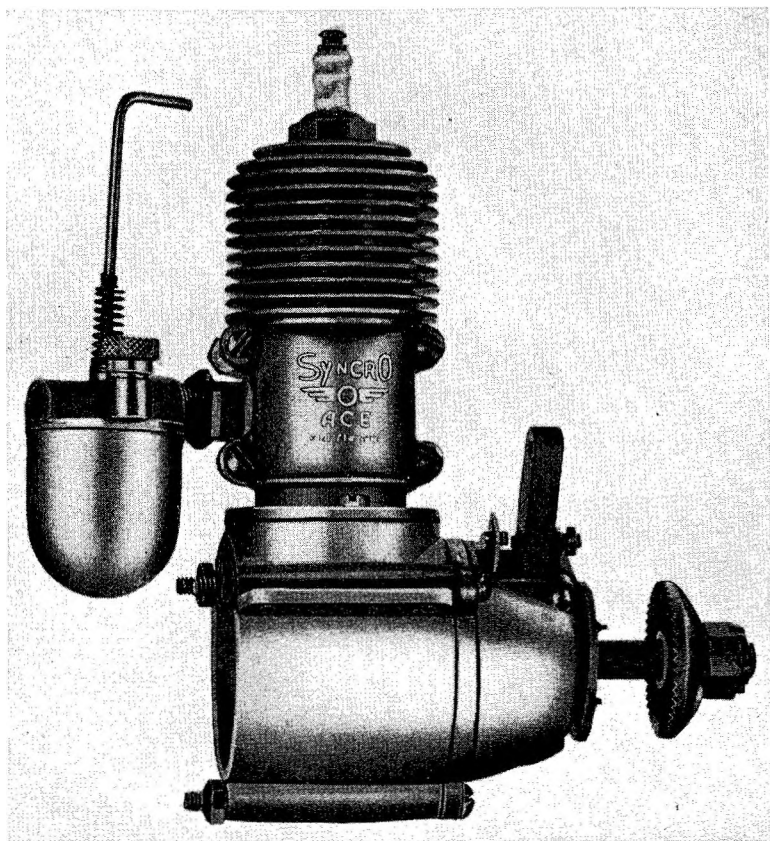

## SPECIFICATIONS

Horsepower—1/5  
Bore  $\frac{7}{8}$ "  
No Piston Rings  
Weight 10 Ozs.

Displacement .564 Cu. In.  
Stroke  $\frac{1}{8}$ "  
Class C  
List Price, \$9.95

The accessories shown on the above motor are standard equipment. Replacement accessories are listed on pages 28-29.

# SYNCR O BEE

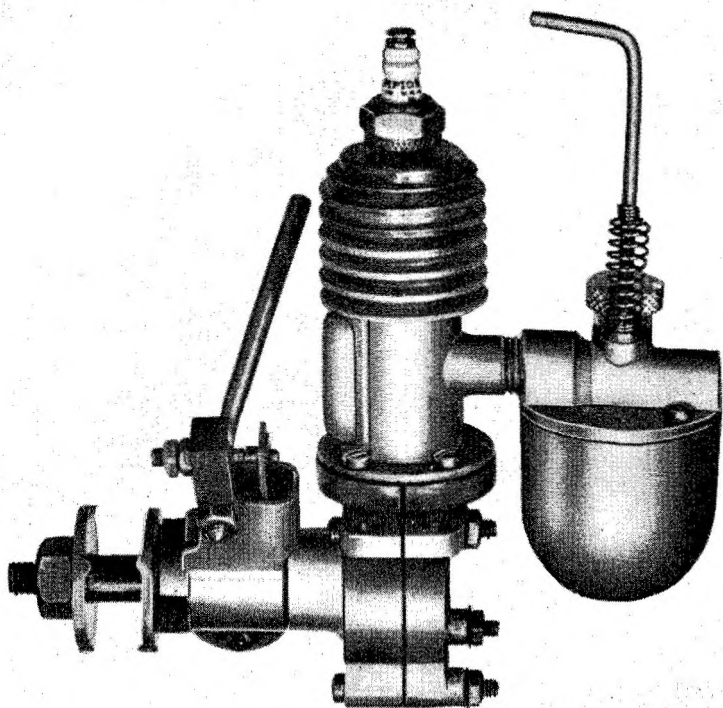

## SPECIFICATIONS

Horsepower— $\frac{1}{8}$   
Bore  $\frac{1}{2}$ "  
No Piston Rings  
Weight  $3\frac{3}{4}$  Ozs.

Displacement .122 Cu. In.  
Stroke  $\frac{5}{8}$ "  
Class A  
List Price \$12.50

The accessories shown on the above motor are standard equipment. Replacement accessories are listed on pages 28-29.

# SUPER CYCLONE "G"

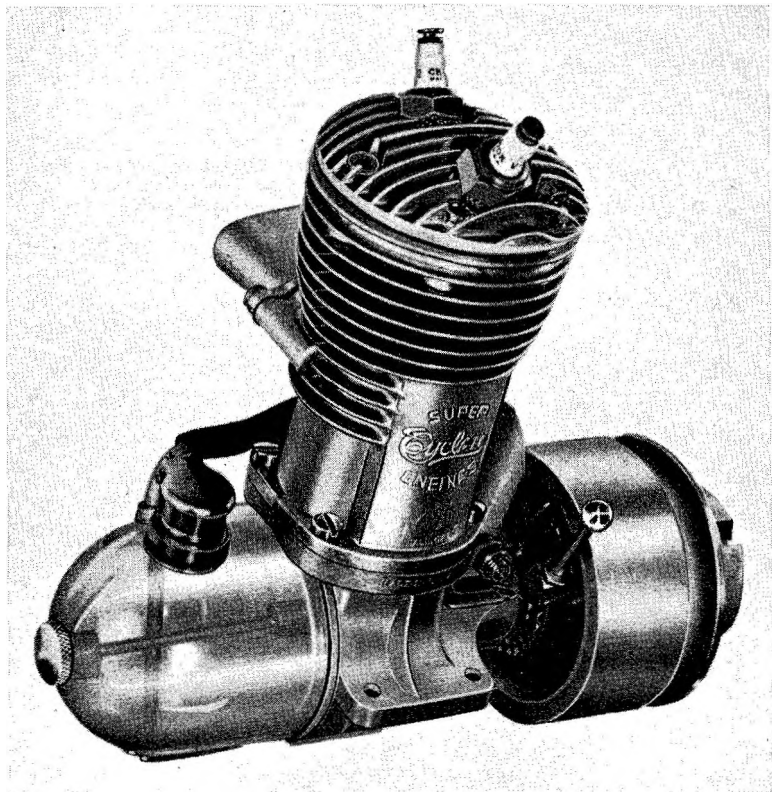

## SPECIFICATIONS

Horsepower—1/5

Bore  $\frac{15}{8}$ "

No Piston Rings

Weight 7 Ozs.

Displacement .65 Cu. In.

Stroke  $\frac{15}{8}$ "

Class C

List Price, \$15.00

The accessories shown on the above motor are standard equipment. Replacement accessories are listed on pages 28-29.

Name	Class	Weight in Oz.		Displacement in Cubic Ins.	Bore	Stroke	Cycle	Ports	Rated H.P.
		Bare	Flying						
AJAX	C	6½		.363	¾"	1¾"	2		½
ALTERNATE FIRING TWIN	C		19	.326	⅝"	1⅞"	2	4	⅓
AVION MERCURY	Open	21¾	36	1.53	1¼"	1¼"	2		¾
ATOM	A	2	3½	.097	½"	½"	2	9	⅛ - 1/10
BANTAM	A	2¾	7.02	.165	19/32"	19/32"	2	3	¼
BRAT	A	3½	8	.155	9/16"	⅝"	2	4	¼
BROWN B	C	6½	21½	.6	⅞"	1"	2	4	⅓
BROWN C	C	6½	21½	.6	⅞"	1"	2	4	⅓
BROWN D	C	6½	21½	.6	⅞"	1"	2	4	⅓
BROWNIE E	B			.29	.770"	⅝"			¼
BELMONT	C	9	22	.564	⅞"	15/16"	2	4	¼+
BUNCH "MIDGET"	C	6½	21½	.45	⅞"	¾"	2	4	15-1/4
CONDOR	A	3	7½	.18	⅝"	19/32"	2	4	⅓
CYCLONE	C	6½	20	.363	¾"	13/16"	2	3 Port Rotary Valve	⅓
DENNYMITE	C	10	21	.563	9/10"	9/10"	2	4	¼
ELF	A	4	8	.140	9/16"	9/16"	2	4	13/32
FORSTER	C	14	25	.997	1 1/16"	1 1/8"	2	4	⅓
G. H. Q.	C	10	18-20	.518	15/16"	¾"	2	4	⅓
GWIN-AERO	C	6½	21½	.45	⅞"	¾"	2	4	16-1/4
GNAT	A	4½	8	.156	9/16"	⅝"	2	4	1/10
HUSKY "J. V."	A	2¾	6	.192	⅝"	⅝"	2	4	⅓
HURLEMAN	C	6.7	21	.460	⅞"	13/16"	2	4	⅓
IMP G-9	C	9	14	.565	⅞"	15/16"	2	4	⅓+
JAMES	C	8	22	.647	15/16"	15/16"	2	4	¼
KAYDET	A	4	8	.163	⅝"	17/32"	2	4	¼
LITTLE DYNAMITE	C	6½	21½	.375	.781"	.781"	2	Rotary Valve	⅓
M & M	B	4½	11	.292	23/32"	23/32"	2	4	¼
OHLSSON "19"	A			.199					
OHLSSON "23"	B	4	9	.213	⅝"	11/16"	2	4	¼
OHLSSON "60"	C			.60	15/16"	⅞"			⅓
GOLD SEAL	C	8	22	.564	⅞"	15/16"	2	4	⅓
O. K. TWIN	Open	18	28	1.21	.900"	.950"	2		½
O. K. STANDARD	C	7¾	21	.616	.900"	31/32"	2	4	⅓+
O. K. SPECIAL	C	7¾	21	.616	.900"	31/32"	2	4	⅓+
PEE-WEE	A	5	9	.140	9/16"	9/16"	2	4	1/10
PHANTOM "G"	A	3½	8	.276	¾"	⅝"	2	2	¼
REBEL	A	4½	8	.230	⅝"	¾"	2	4	¼
SYNCRO "ACE"	C	10	21	.564	⅞"	15/16"	2	4	16-1/4
SYNCRO "BEE"	A	3¾	8	.122	½"	⅝"	2	4	⅓
TORPEDO	C	4¾	9	.304	¾"	11/16"	2	2 Port Rotary Valve	⅓
TROJAN	A	5	9	.232	11/16"	⅝"	2	4	¼

# SPECIFICATIONS

R. P. M.	Fuel Parts		Propeller		Mount	Block Tested	Type of Gas Feed	Minimum Weight of Plane in Oz.
	Min.-Max.	Gas White	Oil SAE-70	Dia.				
500- 8000	3	1	14"	8"	Beam-Radial	Yes	Suction	29.00
500- 8000	4	1	14"	8"	Beam	Yes	Suction	26.10
500- 3800 +	4	1	20"	10"	Beam	Yes	Suction	12.23
250-17500	3	1	10"-12"	6"-7"	Beam	Yes	Suction	7.76
500-10000	3	1	10"-12"	6"-7"	Beam	Yes	Suction	13.20
500- 8000	3	1	9"	6½"	Beam	Yes	Suction	12.40
500- 7000	3	1	14"	8½"	Beam	Yes	Suction	48.00
500- 7000	3	1	14"	8½"	Beam	Yes	Suction	48.00
500- 7000	3	1	14"	8½"	Beam	No	Suction	48.00
To- 8600	4	1	14"	8½"	Beam	No	Suction	45.10
To- 7500	3	1	12"	6½"	Beam	No	Suction	36.00
500-15000	5	1	11"	8½"	Beam	Yes	Suction	14.40
500- 5500	3	1	12¾"	8"	Beam	Yes	Gravity	29.00
500- 6500 +	3	1	13"-14"	7½"-8"	Beam	Yes	Suction	45.00
To- 4500	8	1SAE60	12"	6½"	Beam	Yes	Suction	11.20
Jp to 5000	3	1	16"	10"-12½"	Beam or Radial	Yes	Suction	79.80
	4	1	18"					
	10	1	20"					
300- 7000	5	1	14"	8"	Beam	Yes	Suction	41.45
To- 7500	3	1	12"	6½"	Beam	No	Suction	36.00
To- 7500	3	1	10"-12"	6"-7"	Beam	Yes	Suction	12.48
250- 8000	3	1	11"	8½"	Beam	Yes	Suction	15.35
500- 8000	4	1	14"	8½"	Beam	Yes	Suction	35.80
300- 7000	3	1	13"	7½"	Beam	Yes	Suction	45.20
To- 7000	4	1	13"	7½"	Beam or Radial	Yes	Suction	51.80
500- 8000	¾	1	10"-12"	6"-7"	Beam	Yes	Suction	13.33
To- 6000	3	1	14"	8½"	Beam	Yes	Optional	30.00
500- 8000	3	1	11½"	8½"	Beam	Yes	Suction	23.39
500-10000	2	1	10"-12"	6"-7"	Beam-Radial	Yes	Suction	16.98
500-10000	3	1	14"	8½"	Beam-Radial	Yes	Suction	45.10
800-10000	4	1	18"	10"-12½"	Radial	Yes	Suction	96.80
1200-12000	3	1	14"-15"	8½"	Beam-Radial	Yes	Suction	49.30
1200-12000	3	1	14"-15"	8½"	Beam-Radial	Yes	Suction	49.30
500-10000	¾	1	10"	6"	Beam	Yes	Suction	11.20
To- 6500	3	1	11"	8½"	Beam	Yes	Gravity	22.08
350- 5000	3	1	10"-11"	6"-7"	Beam	Yes	Suction	18.4
To-10000	4	1	13"-14"	7½"-8½"	Beam-Radial	Yes	Suction	45.10
1000- 8000	4	1SAE60	9"-10"	6½"	Beam-Radial	Yes	Suction	97.60
To-14000	2½	1	13"-14"	7"-8"	Beam-Radial	Yes	Suction	24.32
To- 6500	4	1	10"	6"	Beam	Yes	Suction	18.56

# MOTOR

## HURLEMAN BIG CARBURETOR

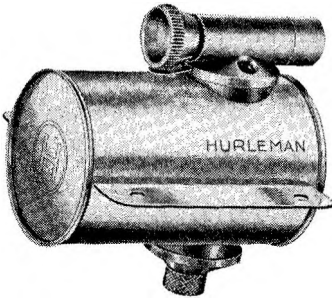

This popular carburetor is made integral with a  $1\frac{1}{4}$  oz. capacity metal tank. It is easily taken apart for cleaning and was designed for large bore motors and midget racers. The Hurleman Carburetor fits all makes of motors and increases R.P.M. as much as 1500. Adaptable to upright or inverted motors. List price, \$3.50.

## HURLEMAN MEDIUM CARBURETOR

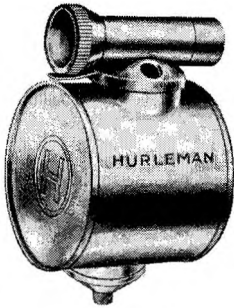

Suitable for average size motors. The integral metal tank has a  $\frac{3}{4}$  oz. capacity. Fits all make motors and is easily taken apart for cleaning. Will also increase R.P.M. 1500. Adaptable to upright or inverted motors. List price, \$3.00.

## HURLEMAN GLASS CARBURETOR

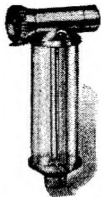

Designed for small motors. The  $\frac{1}{4}$  oz. glass tank is made integral with carburetor. Can also be taken apart for cleaning, is adaptable to upright or inverted motors and increases R.P.M. 1500. Fits all make motors. List price, \$2.50.

If your dealer does not have these accessories, write direct:

**HURLEMAN DISTRIBUTING COMPANY**

1438 W. HUNTING PARK AVENUE — PHILADELPHIA, PENNA.

# ACCESSORIES

## HURLEMAN IGNITION UNIT

This unusually well constructed unit produces a more intense spark from less current. The elements are sealed in a water-proof and oil-proof molded bakelite case. Only five wires: 2 to battery, 1 to timer, 1 to ground of motor and 1 to spark plug. No other connections are required. List price, \$4.50.

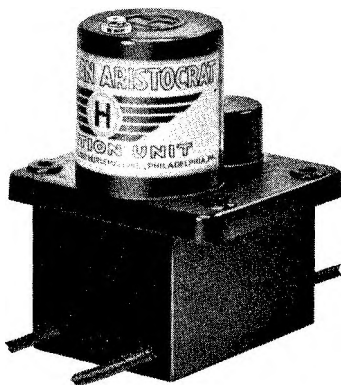

## HURLEMAN TIMER

A sturdy and reliable timer which can be adapted to any make motor, including all model Brown motors and the new Brownie-E. Equipped with adjustable tungsten breaker points. This timer is especially fine as replacement for defective timers. List price, \$2.50.

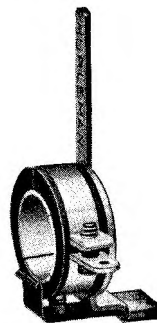

## HURLEMAN SPARK COIL

Here is a coil that never fails! The mounting clip and coil are assembled as separate units. This is a big advantage for model fliers with several planes, but only one motor. List price, \$2.50.



## HURLEMAN SPARK PLUG

The finest plug made. It fits all motors having  $\frac{3}{8}$ " x 24 thd. The Circle H Spark Plug is made in two pieces, with pointed electrodes, and can easily be taken apart for cleaning. Weight  $\frac{1}{4}$  oz. List price, 75c.

