

AMERICAN aircraft modeler

SOUND OF ELECTRIC POWER

SILENCE PAGE 24

PROFILE CARRIER

MO-BIPE PAGE 42



PATTERN DESIGN STATE OF THE ART

PAGE 35

Beginners Control



Look like real planes!

Perfect for
control-line
beginners
solid balsa
construction
withstands
hard landings
time after time

Scientific Beginner Models are better than profiles...here's why:

Most profile models have a plain, flat wing. Scientific's full-fuselage models have an extra-lift, one piece *air-foiled* solid balsa wing. Gives extra lift; makes flying and difficult maneuvers easy.

Scientific models have an exclusive pre-carved balsa body (not just a thin sheet of wood) which gives you a sturdier more realistic flying model.

You also get these other features:

- Extra-strength plywood motor mount
- Strong, formed metal landing gear and wheels
- Complete colorful decals
- Complete control assembly including formed metal bellcrank, hardware, control rod and horn
- Tailwheel or metal skid assembly
- Elevator hinges
- Precision die-cut fin, rudder and elevator
- Plastic engine cowling, canopy and windshield (on most models)
- Complete step-by-step assembly instructions

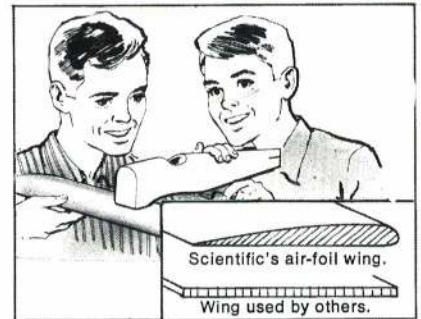

One look will tell you these Scientific kits are designed to get you flying F-A-S-T! Every kit is specially designed for engines .020 to .049. You're not limited to just one engine size. And they're just as easy to build as profile kits . . . but look like a real airplane. Whether you're a beginner or a pro, Scientific flying models are your best buy!

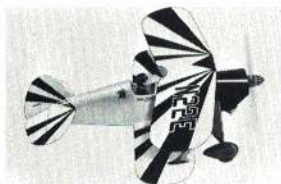

Kit 20 LITTLE STINKER, 18". Popular aerobatic speedster.

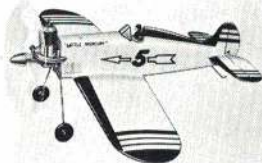

Kit 26 LITTLE MERCURY, 18". Easy to build and fly.

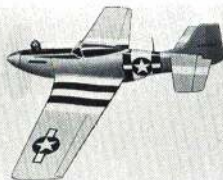

Kit 70 F-51 MUSTANG, 21". Famous WW II fighter.



Kit 72 SUPER STUNTMASER 20". A built-up wing stunt sensation.



Kit 74 MESSERSCHMITT ME-109, 18". German WW II fighter.

HERE'S THE COUNTRY'S HOTTEST

rubber flying model

Sky Master

BIG 36 INCH WINGSPAN

Featured in the Movie
"THE LONG FLIGHT"



YOU FLY IT A MILE . . . with truly amazing performance like you never thought possible. Big deluxe kit includes Hi-Thrust Propeller, Formed Leading and Trailing Edges, Formed Wire Parts, Pure Contest Rubber Drive, Colorful Decals and Full Size (44") Easy to Follow Plans.

\$4.95
KIT 160

SCIENTIFIC MODELS INC.

340DY Snyder Avenue • Berkeley Heights, New Jersey 07922

SEE YOUR DEALER. If kits are not available at dealer, you may order direct from factory adding \$1.00 for postage and handling. Outside U.S.A. add \$2.00.

• Line Models

Fly like real planes!



21 popular models
to choose from:

\$4.95
each

P-40 FLYING TIGER
Kit #59. Famous World War II
Fighter with 18" wingspan.
Looks and flies like the
real plane.

Photos of actual models



Kit 60 STUKA DIVE BOMBER 18"
Scale model of W.W. II fighter



Kit 95 PIPER CUB TRAINER 18"
Famous private trainer

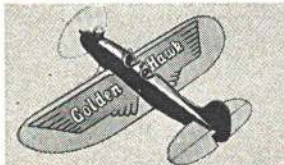

Kit 48 GOLDEN HAWK 18". A great
model for fun flying



Kit 25 STUNT MASTER 18" One of
America's most popular stunt models.



Kit 30 RED DEVIL 18" Great train-
ing model for beginners

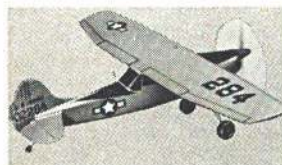

Kit 6 CESSNA BIRD DOG 18" Scale
model U. S. "Flying Jeep"



Kit 54 CESSNA "182" TRI-CYCLE
High performance private plane



Kit 14 PIPER TRI-PACER 18" with
popular tri-cycle landing gear

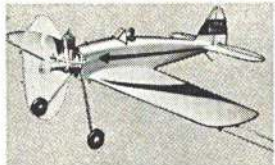

Kit 28 LITTLE DEVIL 18" Fast, easy
to fly, great performer



Kit 7 CESSNA "180" 18" Model
has good looks, great speed

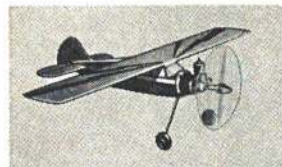

Kit 53 RED FLASH 18" Model has
sleek looks, good control



Kit 8 PIPER CUB CRUISER 18"
Most famous of all Piper Cubs



Kit 65 ZIG ZAG 18" A stunt sensa-
tion, great looks too



Kit 18 LITTLE MUSTANG 18" Fast
easy to fly semi-scale model



Kit 29 LITTLE BIPE Big 70 sq. in.
wing area, 2 preshaped wings

Send for our big colorful catalog . . . only 25¢

SEE YOUR DEALER. If kits are not available at dealer, you may order direct from factory adding \$1.00 for postage and handling. Outside U.S.A. add \$2.00.



AMERICAN aircraft modeler

COVER PHOTO

Dario Brisighella's Viper shown with trophies won at Toledo 1972 for the most outstanding pattern design and best finish. The Viper was finished in dope over balsa framework. Photographed by John Kozy. Turn to page 35 for complete article.

VOLUME 76, NUMBER 1—JANUARY 1973

ARTICLES

<i>Jack Headley</i>	24	THE SOUND OF THINGS TO COME
<i>Clarence Haight</i>	39	720 TURN
<i>Dario Brisighella</i>	35	VIPER
<i>Don Gerber & Harry Higley</i>	42	MO-BIPE
<i>Bob Wischer</i>	46	SCALE WORLD CHAMPIONSHIPS
<i>Ken Willard</i>	58	AN RC RVP

FEATURES

<i>Jim McNerney</i>	10	GETTING STARTED IN RC
<i>Lorelei Snyder</i>	16	ON THE SCENE: THE NEW CHARLES RIVER RADIO FLYING SITE
<i>Fred Marks</i>	18	ORBIT'S CUSTOM SIX-CHANNEL SINGLE STICK
<i>Van Highers</i>	20	KIRKLAND'S A6 INTRUDER BY SKY GLAS
<i>Joel Rieman</i>	52	FOR THE TENDERFOOT: O'FUNGLE
	62	WHERE THE ACTION IS

ACADEMY OF MODEL AERONAUTICS

96	JOHN WANAMAKER'S CONCOURS d'ELEGANCE
98	AMA NEWS BITS
99	PRESIDENT'S MEMO
100	RC MASTERS CONTEST
102	CONTEST CALENDAR

DEPARTMENTS

<i>Edward C. Sweeney, Jr.</i>	6	EDITORIAL
	12	MODELER MAIL—LETTERS TO THE EDITOR
	22	NEW PRODUCTS CHECK LIST
	95	INDEX TO ADVERTISERS
	106	QUALITY SHOPS/CLASSIFIED ADVERTISING

MO-Bipe—page 42

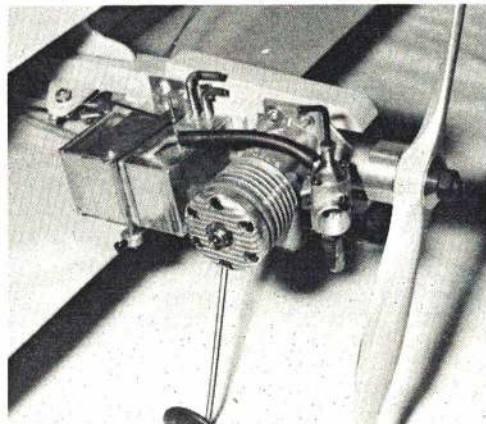

The Sound of Electric Power—page 24

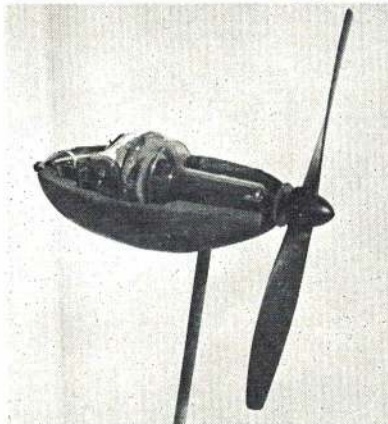

Potomac Aviation Publications, Inc.

733 15th Street, N.W.,
Washington, D.C. 20005

Edward C. Sweeney, Jr.
Editor and Publisher

Anna Maria Nunez
Managing Editor

Kelly M. Matthews
Art Director

Contributing Editors

Bob Beckman
John Blum
John Burkam
Bill Boss
Bob Hatschek
Don Lowe
Fred Marks
Carl Maroney
Claude McCullough
Bob Meuser
Walt Mooney
Howard Rush
John Smith
Bob Stalick
Bob Stockwell
Bud Tenny

Carolyn A. Munson
Art Associate

William P. Kochanski
Computer Composer

Joseph R. Wright
Circulation Development

Gretchen Knowles
Subscription Manager

Mark K. Winter
Subscription Assistant

Harvey E. Cantrell
Business Manager

Abdul M. Sayeedi
Assistant Business Manager

Douglas Boynton
Advertising Sales Manager

David M. Boynton
Asst. Advertising Sales Manager

Benjamin Millsbaugh, M.S.
Advisor to Potomac Aviation Publications
for Aerospace Education

Stella Reed, M.S.
Advisor to Potomac Aviation Publications
for Libraries/Chairman, Board of Advisors
for Child Education

Published monthly by Potomac Aviation Publications, Inc., 733 Fifteenth Street, N.W., Washington, D.C. 20005. Edward C. Sweeney, Jr., President; Walter L. Hulsted, Treasurer; Harvey E. Cantrell, Business Manager and Secretary.

ADVERTISING DEPARTMENT: 733 15th Street, N.W., Washington, D.C. 20005. (202) 737-4288. Western Advertising Representative: Aaron D. Viller & Associates, 5311 Venice Blvd., Los Angeles, California 90019. Tel: (213) 939-1161. Eastern & Midwestern Advertising Representative: Douglas Boynton, 733 15th Street, N.W., Washington, D.C. 20005. Tel: (202) 737-4288. **SUBSCRIPTION RATES:** In U.S., Possessions and Canada, 1 Year, \$9.00; 2 Years, \$16.00; 3 Years, \$23.00. Elsewhere \$11.00 for one year. Payable in advance. Single copies \$1.00. Six weeks are required for change of address. In order a change write to American Aircraft Modeler, 733 Fifteenth Street, N.W., Washington, D.C. 20005. Give both new and old address as printed on last label. We cannot accept responsibility for unsolicited manuscripts or artwork. Any material submitted must include return postage. When writing the editors address letters: Editorial Office, American Aircraft Modeler, 733 Fifteenth Street, N.W., Washington, D.C. 20005.

POSTMASTER: Send Form 3579 to American Aircraft Modeler, 733 Fifteenth Street, N.W., Washington, D.C. 20005.

Second class postage paid at Washington, D.C. and at additional mailing offices. © Potomac Aviation Publications, Inc. 1972. All rights reserved. Printed in the U.S.A.

Power play.

That's when you have the advantage. And use it.
It's when you're one up.

And we've built the Champion to get you there.
The Champion's our workhorse, designed to
give you the power and control.

It's reliable. It's fun.

The Champion has adjustable sticks, allowing
you to regulate stick tension to your own
individual preference.

The Champion has a highly selective, solid
state receiver.

The Champion has the smallest, lightest
servos available anywhere.

All Champions have six channels. And you
can choose either one or two sticks.

What price, power?

\$349.95 for the two-stick, six-channel Champion.

\$369.95 for the one-stick, six-channel Champion.

That includes transmitter, receiver, 4 servos,
battery pak and charger. Reasonable.

EK-logictrol Champion.

Try it. Price it. Fly it.

And if you mean to stay in the air, take
the controlled approach.

EK-logictrol
The controlled approach

For our full-line brochure, write: EK-logictrol, 3233 W. Euless Blvd., Hurst, Texas 76053



ED SWEENEY



EDITORIAL

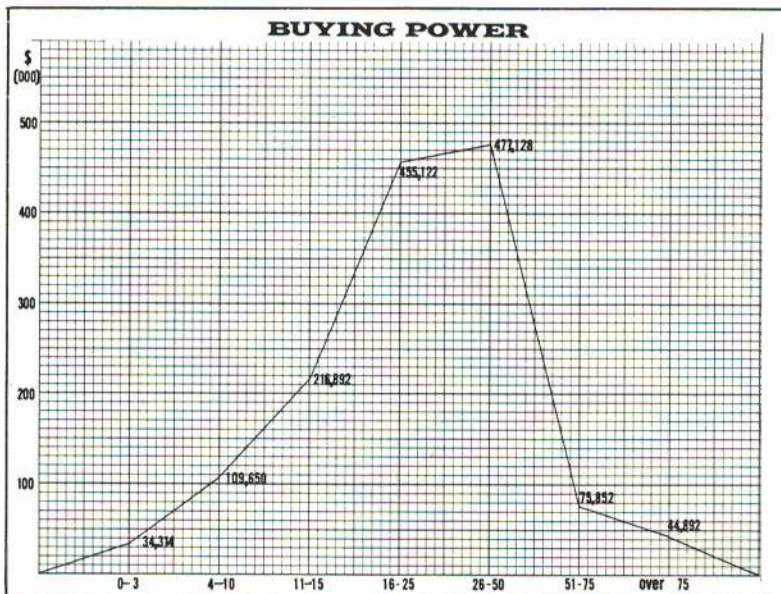
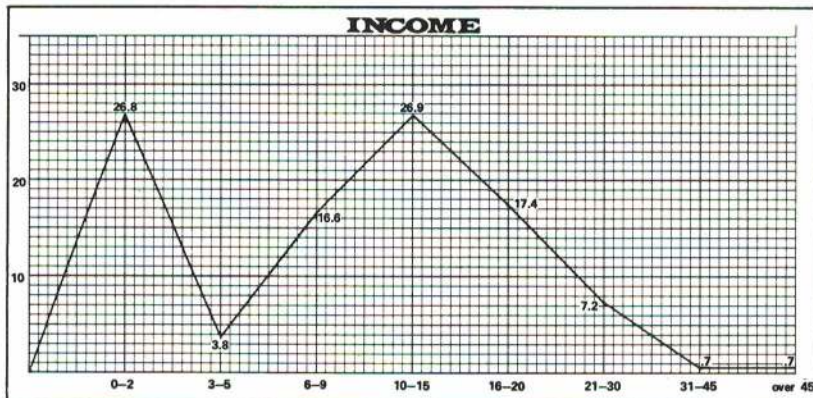
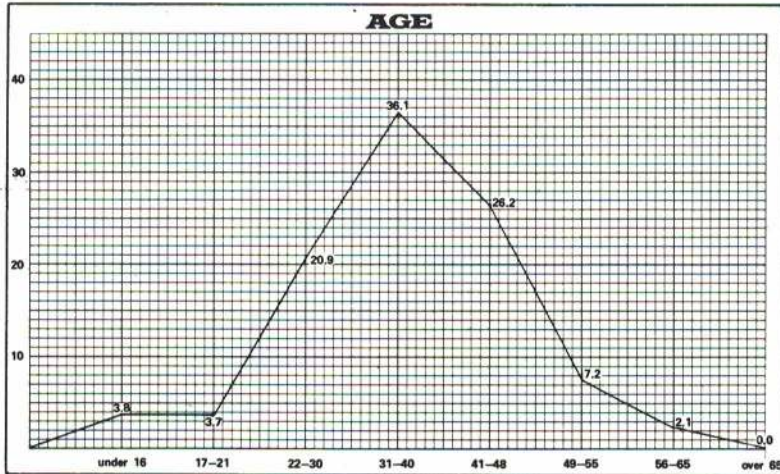

Periodically magazines survey their readers to learn about reader interests, age, income, editorial likes and dislikes, advertising effectiveness, etc. Surveys especially show up any changes in readership patterns. Our first survey appeared in the May 1972 issue of AAM. It was bound into every copy printed; total print for that issue was 129,475 copies. The response was very heavy—7716 surveys were completed and returned. This healthy number of responses shows our reader's genuine interest in the magazine. Total single copy sales for that issue was 79,500 copies, (Yearly average for 1972 is up significantly to 87,000 as shown on this month's Owner's Statement, AMA membership peaks near the end of August giving us this variation in addition to other seasonal factors) so our response was from just under 10% of the readers.

Where possible, we are showing the survey results in graph form. In these graphs, meaningful information was taken from the responses by computing them on a percent-of-replies basis. In others, we related the percent-of-reply to the whole readership in establishing dollar values for each reply category.

How do you fit the response groups? Did you send in a survey? If not, find your back issue and fill it in. Then read on, and compare yourself to the rest of AAM's readers.

There are several things we will be doing with this survey information. For example, some of the editorial makeup of AAM will change. Circulation promotion efforts will be modified in order to appeal more closely to the prospective reader. Advertisers may alter their messages to attract some of the Control Line fliers into RC instead of reselling present RCers. In general, you, the reader, will have a magazine with which you as an individual can identify more closely.

AGE

Proportionately, students are a very small but extremely important part of a model magazine's readership. They are the future involved modelers. Normally we attract a young person to modeling during grade school, but he loses interest in models during high school due to the pressures of school, girls and cars. During the years 22 to 30 many new people get into models and most of the young builders come back. Surveys have

(Continued on page 14)

FIRST PRIZE



GOES TO THE EGGSHELL

MOTHER NATURE DID A TOP-NOTCH JOB WHEN SHE CREATED THE EGGSHELL.

IT'S WATERPROOF. COMPLETELY SEALED. LIGHTWEIGHT, BUT STRONG. SMOOTH AND UNIFORM. IT'S MOLDED TO CONFORM PERFECTLY TO WHAT IT COVERS. IT WON'T PEEL OR FADE. AND IT PROTECTS THE EGG FROM HEAT AND COLD.

BUT, WHEN IT COMES TO COVERING A MODEL AIRPLANE, MONOKOTE IS ALL THESE THINGS, TOO. IN FACT, THERE ARE EVEN SOME THINGS MONOKOTE HAS OVER THE GOOD OL' EGGSHELL.

FIRST OF ALL, YOU CAN COVER YOUR MODEL WITH MONOKOTE IN A LOT LESS TIME THAN IT TAKES A HEN TO MAKE A SHELL.

AND YOU WOULDN'T THINK OF REPAIRING AN EGGSHELL ONCE IT CRACKS. BUT, WHEN YOU HAVE A LITTLE CRACK-UP WITH YOUR PLANE, YOU CAN REPAIR MONOKOTE INSTANTLY AND ALMOST INVISIBLY.

THEN, OF COURSE, AN EGG ONLY COMES IN TWO COLORS (EXCEPT AT EASTER). BUT, MONOKOTE COMES IN 18 COLORS, INCLUDING METALLICS AND PAINTABLE CLEAR.

SO, WHEN YOU THINK ABOUT IT, BEING THE WORLD'S SECOND GREATEST COVERING ISN'T BAD . . . BECAUSE, IN THE MODELING FIELD, WE'RE NUMBER 1.



TOP FLITE MODELS, INC.
2635 S. WABASH AVE.
CHICAGO, ILL. 60616

HP HOBBY PEOPLE

130 East 33rd St., Los Angeles, Calif. 90011
 PRICES GOOD UNTIL JAN. 20TH. 1973

JANUARY WAREHOUSE CLEARANCE!...



CAN'T WAIT? CALL (213) 233-4484
 FOR FAST C.O.D. SERVICE



Svenson FLY-BOY



REG. \$55.00
our price \$37.88

includes all hardware

SVENSON SPECIAL

Svenson MINI-MULTI



REG. \$25.00
our price \$18.88

includes all hardware

Svenson SLY-CAT



REG. \$50.00
our price \$34.88

includes all hardware

Svenson AZIZO GLIDER



REG. \$28.00

includes all hardware
our price \$17.76

Svenson K8B GLIDER



REG. \$50.00
our price \$34.88

includes all hardware

ANDREWS AERO MASTER

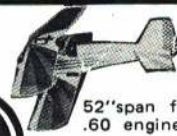

REG. \$42.95
our price \$28.88

52" span for .60 engine.
 Limited supply



REG. \$50.00
our price \$28.88



REG. \$55.00
our price \$32.67

BRIDI KAOS with NEW VECO .61



REG. \$125.00
our price \$69.88

59" span, for .49 to '61 engine.



REG. \$22.00
our price \$14.99



REG. \$45.00
our price \$29.99

TOP FLITE P-40 R/C



REG. \$50.00
our price \$34.88

60" span for '40 to '60 engine.



REG. \$23.00
our price \$13.88

46" span for .19 to .23 engine.

TOP FLITE R/C NOBLER



REG. \$30.00
our price \$21.47

51" span for .29 to .40 engine.

LANIER COMET



REG. \$50.00

63" span for .50 to .60 engine.
our price \$34.47



REG. \$25.00
our price \$14.61

42" span for .19 to .23 engine.



V.K. NAVAJO

REG. \$40.00
our price \$27.88

TOP FLITE CONTENDER



REG. \$35.00

our price \$19.99



REG. \$22.00
our price \$12.99



V.K. CHEROKEE

REG. \$40.00
our price \$27.88

65" span for .40 to .61 engines.

REG. \$20.00 ...**\$12.99**
 REG. \$30.00**\$18.99**

STERLING SCHWEITZER 126
 SCHWEITZER 134

70" span and 8 Ft. 2 1/2" span.



REG. \$15.00
our price \$9.99

MIDWEST ESQUIRE



JOY JENNY

REG. \$50.00
our price \$34.47

66" span for .29 to .49 engine.

HOBBY PEOPLE : 130 EAST 33RD. ST. LOS ANGELES, CALIF. 90011

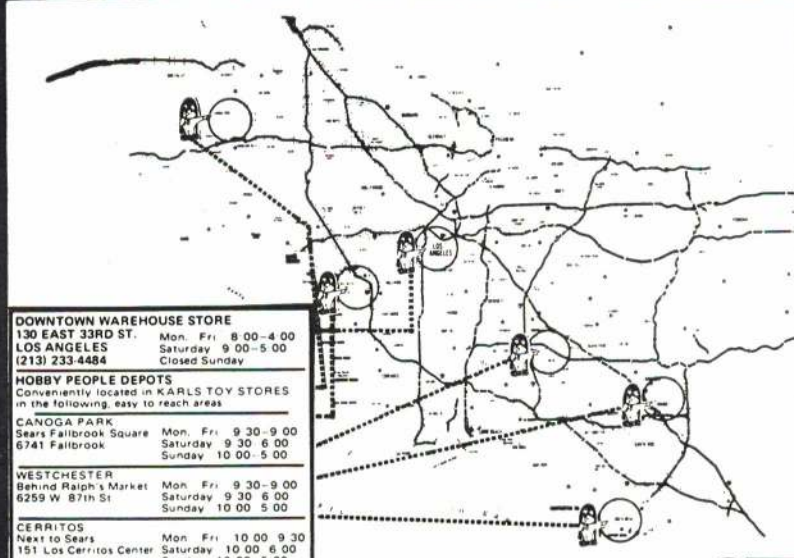

DOWNTOWN WAREHOUSE STORE
 130 EAST 33RD ST.
 LOS ANGELES (213) 233-4484
 Mon. Fri. 9:00 - 4:00
 Saturday 9:00 - 5:00
 Closed Sunday

HOBBY PEOPLE DEPOTS
 Conveniently located in KARLS TOY STORES
 in the following, easy to reach areas

CANOGA PARK
 Sears Fallbrook Square
 6741 Fallbrook
 Mon. Fri. 9:30 - 9:00
 Saturday 9:30 - 8:00
 Sunday 10:00 - 5:00

WESTCHESTER
 Behind Ralph's Market
 6259 W. 87th St.
 Mon. Fri. 9:30 - 9:00
 Saturday 9:30 - 6:00
 Sunday 10:00 - 5:00

CERRITOS
 Next to Sears
 151 Los Cerritos Center
 Mon. Fri. 10:00 - 9:30
 Saturday 10:00 - 6:00
 Sunday 12:00 - 5:00

ORANGE
 Mail of Orange
 2279 N. Orange Mail
 Mon. Fri. 10:00 - 9:00
 Saturday 10:00 - 6:00
 Sunday 12:00 - 5:00

NEWPORT BEACH
 Opposite Broadway
 50 Fashion Island
 Mon. Fri. 9:30 - 9:30
 Saturday 9:30 - 6:00
 Sunday 10:00 - 5:00

These DISCOUNT PRICES
 are available at all
 Hobby People Depots until
JANUARY 20, 1973

OVER 200 PAGES FULLY ILLUSTRATED
1973
GIANT DISCOUNT HOBBY CATALOG
 THE FINEST ALL IN ONE HOBBY CATALOG EVER
 FEATURING: R/C SPORTS (PLANES, BOATS, CARS,
 RADIOS, ENGINES, ETC.), PLASTIC MODELS,
 WOODEN SHIP MODELS, COMPLETE O' HO &
 N' RAILROADING, EDUCATIONAL SCIENCE
 AND MUCH, MUCH MORE!

HP HOBBY PEOPLE
 130 EAST 33RD STREET
 LOS ANGELES, CALIFORNIA 90011

I enclose \$1.00/\$2.00 (outside of Continental U.S.) for HOBBY PEOPLE'S interest hobby catalog. Please rush it to me today!

NAME _____
 ADDRESS _____
 CITY _____ STATE _____ ZIP _____

POSTAGE AND HANDLING
 UP TO \$5.00 ADD 60¢ \$20.01 TO \$30.00 ADD \$2.50
 \$ 5.01 TO \$ 8.00 ADD 80¢ \$30.01 TO \$50.00 ADD \$2.70
 \$ 8.01 TO \$15.00 ADD \$1.10 ORDERS OVER \$50.00
 \$15.01 TO \$20.00 ADD \$1.50 PLEASE ADD . . . \$3.00

CALIFORNIA RESIDENTS ADD 5% SALES TAX!

HOBBY PEOPLE'S WAREHOUSE STORE
 OPEN TO THE PUBLIC: MON - FRI. 8 a.m. to 4 p.m. OPEN SAT. 9 a.m. to 5 p.m.
 130 EAST 33rd STREET, LOS ANGELES, CALIFORNIA 90011
 TELEPHONE: (213) 233-4484



QUARTER MIDGET SPECIAL
YOUR CHOICE
STAFFORD MUSTANG
OR HOT LINE CASSUTT
WITH A K&B .15R/C



VALUE \$67.00
 OUR PRICE \$46.47

BONUS
FREE WILLIAMS BROS.
WHEEL PANTS

HOBBY PEOPLE'S QUIET-TONE MUFFLERS

CUSTOM MACHINED FOR EXACT FIT. HEAVY STEEL FOR SECURE AND EASY MOUNTING. GREAT FOR SCALE. REG. \$10.00

SIZES AVAILABLE—
 VECO .19, VECO .61,
 K&B .40, O.S. MAX .15R/C
 O.S. MAX .60, O.S. MAX 15 STD.

OUR PRICE **\$3.47**



DE LUXE CAN WINCH
 Complete and ready to use. Includes 100 ft. of 18"x 3/64 surgical tubing, 400 ft. of 30 lb. test nylon monofilament line, special parachute, metal stake and all fittings.

NOW **\$29.95**

DU-BRO PB-295 PROP BALANCER

FITS ALL PROPS— 1/4" hole and up
A BALANCED PROP MEANS:
 Better performance — More rpm —
 Extended engine life — Less vibration —
 protect radio — Longer plane life

ONLY **\$1.99**
 PRECISION MADE — POLISHED STEEL

SPECIAL PURCHASE

FLEX Reg. \$1.50..... 99¢ Semi-FLEX Reg. \$1.25.....87¢ SULLIVAN TANKS 2 OZ. \$1.25.....\$.88 4 OZ. \$1.50.....\$.99 6 OZ. \$1.75.....\$1.27 8 OZ. \$1.75.....\$1.47 10OZ. \$1.95.....\$1.47 12OZ. \$1.95.....\$1.47	DU-BRO QUICK LINKS Reg. \$3.36.....\$1.99 RUBBER BANDS NO. 62 Reg. \$1.25.....\$.67 DU-BRO HINGES PKG. of 15 Reg. \$2.49.....\$1.49 DU-BRO KWIK-GLOW Reg. \$2.00.....\$1.35
---	---

HOBBY PEOPLE DISCOUNT PRICE

AERO GLOSS PAINT SALE

PINTS: CUB YELLOW/ REG. \$2.29 EACH
 CUB ORANGE/STEAR- OUR PRICE
 MAN RED/CURTISS
 BLUE/JET BLACK/
 SWIFT WHITE/CLEAR/ \$1.59
 BONANSA BLUE
YOUR CHOICE
 QUARTS: CUB YELLOW/ REG.
 STEARMAN RED/ JET \$3.69 EACH
 BLACK/ SWIFT WHITE/ OUR PRICE
 CLEAR YOUR CHOICE \$2.59

SAVE 30%



HOBBY PEOPLE: 130 EAST 33RD. ST. LOS ANGELES, CALIF. 90011

FIFTY-FOURTH IN A SERIES

getting started in R/C

JIM McNERNEY

We have talked a lot about how accurate the radio must be in moving the servos precisely corresponding to the movements of your hands on the controls. All this precision can be wasted if extreme care isn't used in getting the signal from the servo to the control surface. In this part of the series we'll talk about some important considerations in installing linkages, techniques that have proved successful and the type of linkages available.

Begin planning your radio installation before you glue the first two pieces of wood (plastic, fiberglass, etc.) together on your new model. A common mistake is to build the model completely and then sweat out the radio installation. The result is a compromise which makes the installation more difficult and less efficient than a pre-planned installation.

First, lay out the plans for your model. Place the radio components over the plan in the approximate positions they will occupy in the finished model. Here are six considerations to keep in mind when placing the components:

- (1) There must be enough room, (i.e., allow for padding around the receiver and battery, make sure the servo mounting tray fits).
- (2) Allow an unobstructed run from the servo output to the desired control.
- (3) Consider the effect of the radio components and linkages on the center of gravity (CG) of the plane.
- (4) Allow the receiver antenna to exit the model near the receiver and keep it away from the servos.
- (5) Make components accessible for easy plug-in and removal.
- (6) Make the switch and charging plug easily accessible from the outside.

Check the linkage runs from the servos to the controls. Decide what kind of linkage you will use. Figure locations of holes in bulkheads, ribs, sides, formers, etc., for linkages, tubes and harnesses. Determine control horn and bellcrank locations and mark everything on the appropriate structural pieces. It's a lot easier and more accurate to drill holes in flat wood than in a built-up model, so cut all the holes now. It's also a good idea to lay up the fuselage and wing without gluing to make sure all the holes line up. One of the trickier problems is nose gear steering. You must allow for movement in both directions. The arm generally protrudes into the engine or fuel tank compartment and must be accommodated. This is also true of the connecting linkage. Throttle linkages must be planned carefully as well. They can interfere with cowling struc-

ture, motor mounting bolts, mufflers fuel lines and fuel tanks.

Now is also a good time to consider servo direction. Figure out which way the servo must travel to move the control surface in the right direction. Control direction can be reversed putting the control horn on the opposite side of a surface, by using the opposite arm of the servo, or by an internal modification on most servos. Radio manufacturers often provide two servos which rotate in each direction in a four, or more, channel system. Make sure you hook up the ailerons correctly. Remember, for a right bank the right aileron goes up.

Figure 1 shows several methods for attachment of linkages. There should be no play in the connection. The hole in the arm or horn should be approximately the same diameter as the wire or clevis pin which passes through it. The end of the linkage must not drag, hang up or bind on the servo case or airplane structure. At least one end of each linkage must be adjustable, preferably from the outside of the plane. Initial adjustment should be neutral with plenty of available adjustment in both directions. Use thinner linkage for nose gear steering or allow some "give" so that hard landings will not damage servo gears. Use thin wire for throttle linkage or allow "give" to permit setting the idle stop without stalling the servo.

Make sure that control hinges are pinned and glued, and that there is no play in the hinges or linkages. This can lead to flutter, fatigue, loss of control surface or damage to the servo.

Avoid metal-to-metal contact in control linkages, such as metal control horns with metal clevises. This is a prime source of radio interference.

Now, about some types of linkages: A pushrod may be made out of a single piece of wire. This can be used for throttle control or nose gear steering. It may be made from several pieces of wire with bellcranks, such as in an aileron linkage. A common system for elevator and rudder pushrods consists of a piece of wire epoxied to each end. In recent years, manufacturers have produced nylon rods inside nylon tubes with wires threaded into each end. The rod slides into the tube which is fastened to the aircraft structure. A major problem with early versions was the change in length of the rods with changes in temperature. You could take your plane from the warm house or car out into the cold winter air and experience a marked trim change as the rods shrunk. Later versions of these rods are claimed to have minimized this problem, but it's still a good idea to watch out for it.

METHODS OF PUSHROD ATTACHMENT

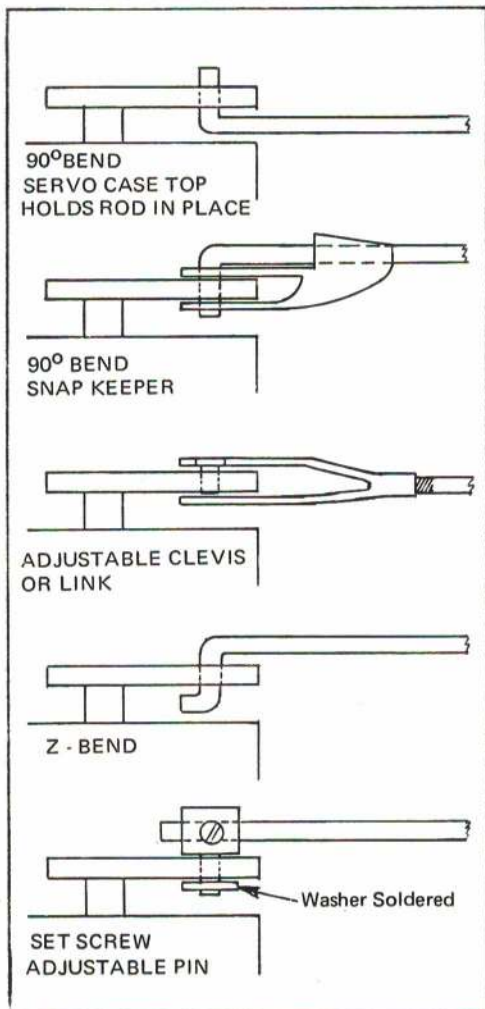



CARL GOLDBERG

NEW RANGER 42

The Versatile Almost-Ready-To-Fly Fun Model.



\$1995

Takes Single To 4 Channel Proportional Radio. Molded Fuselage... One Piece Molded Wing, Stabilizer and Vertical Fin. Also Free Flight. Span 42". Weight 26 oz. For .049-.10 Engines.

SKYLARK 56

\$2295



1-Piece Full-Length Sides

Now With 1-Piece Full-Length Sides. Takes 2 to 4 Channel Proportional. Span 56". Weight 3 1/2-4 1/2 lbs. For .15-.19-.35 Engines.

FEATURES:

- Semi-symmetrical wing section
- Coil-sprung nose gear... formed main gear
- Shaped and notched leading and trailing edges
- Cleanly die-cut ribs, fuse sides, formers, etc.
- New simple "Symmet-TRU" wing construction

JR. SKYLARK

For Single or 2 Channel, Pulse or Digital. Span 37" Weight 18 oz. For .049 Engines. - \$8.95

Skoestring \$2995

The Goodyear Racer With Enough Area and Stability So You Can Fly It! For 4 Channel Proportional. Span 54"; Area 540 sq. in.; Weight 4 1/2-5 lbs. For .19-.40 Engines.

FEATURES:

- Shaped leading edges plus sheeting
- Symmet-TRU wing construction
- Full-length sides, sheeted trailing edges
- Cleanly die-cut ribs, formers, etc.
- Formed spring aluminum landing gear
- Semi-symmetrical wing section.



THE FLYING FALCONS

More Falcons have been built and flown in the past 10 years than any other R/C. For values and features in a functional, rugged airplane, your best bet is a Falcon. Every design element engineered for simplicity and fast-building.

FALCON 56 \$19.95 Medium-Size Trainer. Single To 4 Channel Proportional. Span 56". For .15-.19-.35 Engines.

SR. FALCON \$36.95 Standard Big Trainer. 4 Channel Proportional. Span 69". For .35 To .60 Engines.

JUNIOR FALCON \$7.95 Small Trainer. Single or 2 Channel. Span 37". For .049 Engines.



MODELS THAT ARE REALLY GREAT TO FLY!

SKYLANE 62

Semi-Scale Beauty in a Great Flying Model!



Tough, Roomy Cabin and Front End. For 2 To 4 Channel Proportional. Steerable Nose Gear. Span 62". Weight 4 1/2-5 Lbs. . . . For .35 To .45 Engines.

FEATURES:

- See-through cabin, with die-cut plywood cabin sides
- Shaped leading edges plus sheeting
- Cleanly die-cut parts that fit
- Clark Y wing section, hardwood struts
- Steerable nose gear, formed main gear

1/2A SKYLANE \$9.95

For Single or 2 Channel, Pulse or Digital. Span 42". Weight 22 oz. For .049 To .10 Engines



All Carl Goldberg Models Come With All Major Fittings Such As Nylon Snap-Links, Control Horns, Snap 'R Keepers, Full Size Plans, Illustrated Step By Step, And Folder on How to Set Up and Operate R/C Models.

LOOK WHAT A MODELER SAYS!

"Enclosed is a photo of a model of your SKYLANE 62 which I have just completed. I enjoyed building this plane, it is the first model that I have built in 25 years. Several months ago I observed a group of men flying some R/C models and this rekindled my interest in model planes. Having never built an R/C model, I was dubious which model to build. After some investigation I settled on your kit and I was not disappointed. It was so different from anything that I had built previously and I must say that it went together very easily. The plans were complete, left nothing to guess work. I followed the plans exactly with the exception of the motor and I installed a slightly larger motor, a Max OS 40. I am very pleased with the results. I felt I should write and let you know how much I appreciate this kit and I hope to be able to build all of your planes eventually. Again thanks for such a fine kit."

Arnold B. Johnson
Troutville, Virginia

AVAILABLE IN CANADA

CARL GOLDBERG MODELS INC.

2545 W. Cermak Rd., Chicago, Ill. 60608

I am sending 20¢ for 8 pg. Illustrated Catalog with "Recommendations in Starting in R/C," "Basic Explanation of R/C Equipment, and Radio Control Definitions.

NAME _____

ADDRESS _____

CITY _____

STATE _____ ZIP _____

CARL GOLDBERG MODELS INC.

2545 WEST CERMAK ROAD • CHICAGO, ILLINOIS 60608

P.S. For best service, see your dealer for items you want. If not available, write direct; add 35¢ per item (75¢ outside U.S.). Minimum order \$1.



Modeler Mail

Good plug for hobby

I recently received a questionnaire from Indiana State University. My name had been selected from a random sampling of driver license registrations, being one of 15,000 selected for the whole State of Indiana. It was an Outdoor Recreation User Survey, and the questions ranged from frequency of use and for what reasons, to my views on means to maintain parks and their uses in the future. They were interested in all the "normal" outdoor activities such as camping and snowmobiles, archery and horseshoes. Nowhere was RC even mentioned.

Feeling that I am most likely the only one of the 15,000 sampled who fly RC, I felt almost an obligation to get in a plug for our hobby. I therefore typed a cover letter and attached it to the questionnaire even though such a letter was not requested. Whether it will do any good is only speculation. But I feel all of us have an obligation to promote our hobby when we have a chance, especially when it could mean we have a place to fly or not.

Dale Harber (AMA 70789)
Yoder, Ind.

Likes wholesome AAM

I read the "open letter" published by the editor of RCM magazine regarding

his offer to publish AMA matters free of charge. This would apparently eliminate your publication as the official vehicle of the Academy.

It occurred to me that you might be interested in the reaction of AMA members and readers of AAM. Here, for one, is mine.

This appears to be a "dog in the manger" manipulation. I see little in the proposal that would favor AMA members. Getting your magazine, insurance and membership for ten dollars per annum is a good deal, considering that your subscription rate is \$7.50. (Ed. Note: *This letter applies to \$10.00 open AMA membership and AAM's \$7.50 one year subscription. Both are changed—AMA to \$15.00 and AAM to \$9.00 per year. An even better bargain for the AMA member.*) I also feel that if there is any change, dues for the AMA will remain the same and the member will get less.

This largess of RCM might benefit the AMA but it takes little perception to see who would accrue the greatest benefit. I resist, at least morally, infecting the hobby with "Playboyism" as generated by RCM policy. I am not alluding to the girly aspects but the idea that the hobby should be oriented toward pseudo-sophisticates and an expense-be-damned attitude. This nonsense has had an insidious effect by increasing prices to a point bordering on the ridiculous.

Your magazine still reflects the wholesome flavor of the old time model activity. I hope you overcome this situation as generated by RCM and continue to serve in your present capacity.

Jack George
Brandon, Florida

Reply to Jack George

Your letter is appreciated. Your opinion is held by many other AMA members.

AAM issues are sold to the AMA at 30 cents, they cost AAM 27.6 cents to print and for the paper. Overhead is an additional 10 cents per copy. So AAM

(Continued on page 94)

HOBBY LOBBY

INTERNATIONAL

NEW! Hot Line Models "CRICKET"

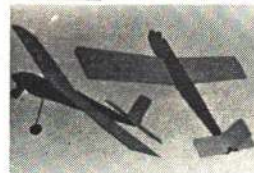

List Price \$16.95
SPECIAL \$13.97

48" wing span, very easy-to-build for .09 to .20 engine, and 2 to 3 channel radio. This stable flyer flies either as a high or low wing plane. In fact, the conversion from high to low wing can be done in 5 minutes at the flying field. Cute idea.

NEW! Hot Line Models "MINI-COMANCHE"



List Price \$29.95
SPECIAL \$22.97

50" wing span semi scale for .15 to .35 engine, and 3 or 4 channel control. This reminds me of V-K's Baby Cherokee and it ought to fly as well as the Cherokee. Conventional balsa wood construction which looks pretty easy on the plan.

NEW! J & J 1/4 MIDGET MUSTANG RACER



List Price \$29.95
SPECIAL \$17.97

This is the winningest 1/4 Midget Kit ever. 40" wing span and a very high speed 10% laminar airfoil. The finished appearance is quite realistically a P-51. Kit has excellent hardware and a well illustrated plan.

NEW! Kraft-Hayes SPONGE WHEELS



These well designed wheels have a hub cap that covers the axle. 2 styles.

Sport Type		Racing Profile Type	
2" pair	\$2.49	2" pair	\$2.79
2 1/4" pair	2.69	2 1/4" pair	2.99
2 1/2" pair	2.89	2 1/2" pair	3.09
2 3/4" pair	3.19	2 3/4" pair	3.19
3" pair	3.29		

HOBBY LOBBY ILLUSTRATED CATALOG \$2.00

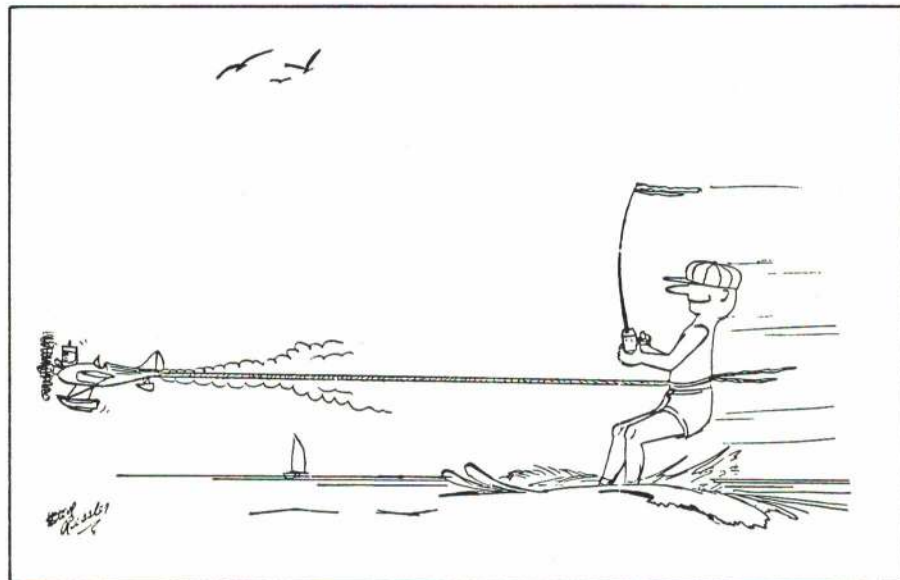

Our new 1973 radio is for the RCer who wants the very best, even if it costs him less.

- Improved Airborne Battery pack with ONE-CELL-OUT flight capability
- Full 90 day Warranty—backed by the manufacturer and by Hobby Lobby
- Extra servos cost only \$12.00 each.
- PRICE: About HALF of what you'd expect to pay for a top quality 5 channel system.
- Unsurpassed Reliability
- Extremely Long Range
- Smallest, Lightest Servos Made
- I.C. FULL-POWER servo amplifiers
- Only 11½ oz. airborne weight
- A complete system: Transmitter, Receiver, 4 servos, all n-cads, charger, 27 or 72 mhz.



Series III HOBBY LOBBY 5 Digital Proportional \$209.

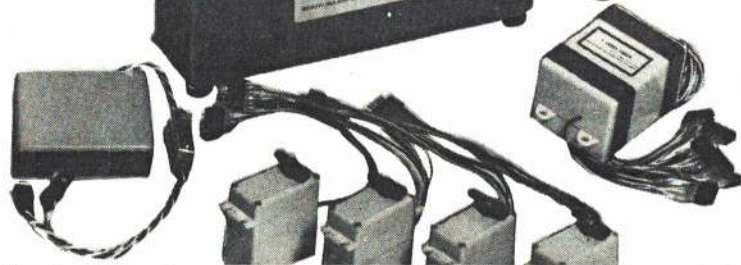

We take very seriously our commitment to our customers to provide an extra reliable radio system that will enhance our own reputation. When we sell our own brand of radio we are the ones who hear the complaints if that radio fails. So, when we tell you that we think the Series III HOBBY LOBBY 5 is as reliable and as precise as the highest priced radio you can buy, you can assume that we ourselves are convinced that this is a true statement.

The Series III HOBBY LOBBY 5 looks almost exactly like the 1972 H/L 5, but the unchanged appearance hides the fact that the radio has been improved both in terms of reliability and system precision.

Here are the major changes:

1. The servo amplifiers are now Integrated Circuit (I. C.) types. These particular I.C. amplifiers apply FULL power to the servo motors down to the last increment of servo motion regardless of the control surface load on the servo. Along with the unusually smooth ball joint in the control stick this new I.C. means that the Series III HOBBY LOBBY 5 will give a measure of precision unsurpassed by any other radio.
2. The single weakest link in any digital proportional system is the airborne battery pack. The Series III HOBBY LOBBY 5 uses a brand new nickel cadmium cell which is designed to operate reliably under conditions of high vibration.
3. The airborne battery pack is now pre-tested both at the factory and by Hobby Lobby. This is a radical test employing high vibration levels, and results in weeding out batteries that have a failure potential.
4. The Series III HOBBY LOBBY 5 uses a circuit that gives you ONE-CELL-OUT flight capability. In the rare event that a cell in the airborne battery pack fails (either shorts out or loses its charge) your Series III H/L 5 continues to fly. In fact, you will not even know that the cell failed.

It would be hard for us to understand why an RCer would want any other brand of digital proportional unless he wants a single stick system. The Hobby Lobby 5 only comes in a two stick version.

Series III HOBBY LOBBY 5 will be available on January 30, 1973.

Please write or call for our free brochure on the Series III.



SENIOR TELEMMASTER
\$49.95

With a 95" wing span this 4 channel behemoth is the largest RC model kit we know of. This is a REAL easy-to-build kit of the finest, lightest balsa wood you'll ever see.

When you get your SENIOR TELEMMASTER all finished you'll have a GREAT BIG monster of an airplane that flies like a tranquilized albatross. It's supposed to use a .40-.60 size engine, but I believe you could keep it in the air with a .19.

NEW! Hobby Lobby's

BRAND Y WHEELS

2" pair	\$1.00
2¼" pair	\$1.15
2½" pair	\$1.30
2¾" pair	\$1.45
3" pair	\$1.55



Blue Max Mark II 6 CHANNEL SEMI KIT



with 4
FULLY ASSEMBLED
SERVOS

\$173.00

Previously, the Blue Max SEMI kit digital proportional has come with one assembled servo (which is used as a reference servo) and three semi-kit servos. Now, ALL 4 SERVOS ARE FULLY ASSEMBLED. This feature not only saves you the time required to assemble the servos, but also guarantees you of perfect completion of the ONLY ticklish soldering job involved in the SEMI kit. The rest of the assembly is very easy.

Outfit includes semi kits for transmitter, receiver-decoder, charger, and 4 assembled servos. Complete n-cads, factory warranty on all factory assembled P/C boards. Your choice of 27 or 72-75 mhz. frequencies.

TRY US OUT: E. A. did

"Nice fast service on my order . . . I bought three catalogs to compare . . . You guys are tops on selection, lower prices, fast service, and no shipping costs."

E. A., West Chester, Ohio

Shelor FOAM WING CUTTER

\$36.95

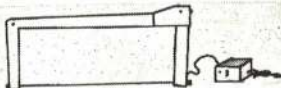

With this well-thought-out cutter you can quickly cut foam wing cores for a material cost of about 67¢ per set. This is a transformer type cutter which eliminates any shock hazard, and has the best instructions I've ever seen covering the method of properly cutting foam wing cores.



HOBBY

LOBBY

INTERNATIONAL

Route 3, Franklin Pike Circle, Brentwood, Tennessee 37027 - 615/834-2323
DROP YOUR ORDER IN THE MAIL BOX, THEN JUMP BACK BECAUSE WE SHIP FAST!
We pay postage on all orders accompanied by check or money order. Satisfaction guaranteed or money refunded. Phone 615/834-2323 Store Hours: 9 a.m. - 5 p.m. except Sundays.

Hobby Shack

2 CH.
\$69.95



UNHEARD OF!

CIRRUS 2 CH. \$69.95
CIRRUS 2 CH. \$69.95
CIRRUS 2 CH. \$69.95

If you have been wanting to get into Radio Control or needed an extra 2ch. system, now is the time. We are offering a full digital 2 channel rig complete with 2 separate servos, IC (integrated circuitry) two wire battery pack (dry) and a two stick transmitter with trim. Unheard of? How can we do it? Simple—the radio is factory direct from us to you. There are no distributors or other middlemen and these savings are passed on to you. For 72mhz. add \$10.00

\$219⁰⁰



CIRRUS Hobby Shack

SIX

In this special you get the 5th servo FREE ! This is the very best and latest technology of the radio industry, backed by quality and service to make your radio dollar go along way!
6 CHANNEL 2 STICK SYSTEM WITH 5 SERVOS !
Customer SPECIAL
\$219.00

27 or 72 mhz.

RCM Basic Trainer & Taipan 15 R/C Combo!



50." Wing Span
2 to 4 Channel
Flying Fun!!!!

\$38⁸⁰

MIDWEST CHIPMUNK & TAIPAN 15R/C -Combo!



46" SPAN Stunt
Trainer- All Foam !

Retail 49.90

\$36⁹⁰

Midwest LITTLE STICK & O.S. 25R/C Combo!



46" Wing Span
414 Square inch
wing area.

Retail
\$46.45

\$34⁸⁰



Joe Bridi's KAO & O.S. .60 R/C Goldhead !

59" Wi-Span
Contest
Flyer!!

\$72⁸⁸

MIDWEST LIL TRI-SQUIRE IDEAL R/C TRAINER, MANY FEATURES !



\$5.99

retail \$11.95

MIDWEST NIEUPORT '17' REALISTIC R/C BIPE. FEATURES: DOUBLE FOAM WINGS!

\$9.99

WING SPAN: 44"
AREA: 504 sq. in.
ENGINES: 15-19



retail \$19.95

AREA: 320 / SPAN: 40" / WEIGHT: 24 Oz
ENGINES: 049 to 099. Plans, windshield, gear and hardware included.

Molded foam wings and stab, formed and plated wire parts, vacuum formed cowl, decals, metal engine mounts and hardware.

6475 KNOTT AVE. BUENA PARK, CALIFORNIA 90620

EDITORIAL

(Continued from page 6)

demonstrated that after a few years of marriage, a husband is ready to build model planes again and that he will remain involved in modeling until nearly 50. AAM's largest single age group is in the 31 to 40 age category.

OCCUPATION

It is quite clear that modelers are well-educated professional or skilled people. Again we note the large percentage of students, probably college level or post graduate. Under military, 6.3% is a significant number in a single group.

HOMEOWNERS OR RENTERS

Homeowners	69.3%
Renters	22.2%
Neither	8.5%

Again we see statistics supporting the idea that modelers are independent, have good income, are well settled in life.

INCOME BRACKET

The large number of persons in the 0 to 2 (thousand) group are students. In the range of 10 to 20 we find over 72.5% of AAM's readers, a group which can well afford the necessities of life and have enough left for this hobby. Later, we will interpret this information to show the reader's buying power and total purchasing strength.

WHAT GOT YOU INTO MODELING?

The last three years have seen significant efforts by clubs to demonstrate their hobby to the public. Of course, we are showoffs anyway, but note how many persons we affected by the demonstrations? Nearly half of the attraction to modeling comes from "watching others." This might also attract the large numbers of adults into the hobby as evidenced by the size of this category in the AGE categories.

Realising that noise attracts onlookers, it seems a shame that we need to quiet our engines. Rubber jobs don't attract spectators. But, on the other

OCCUPATION

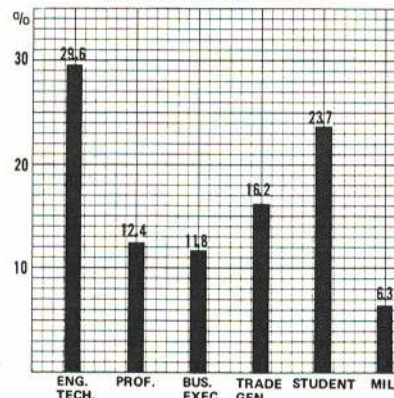

hand, an unmuffled engine annoys the people and would only send them away.

MODELING PREFERENCE

Radio control
Control line
Free flight
Plastics

Quite clearly, the majority interest in AAM is in RC. Nothing new in that. This is also influenced by the advertising in AAM. Nearly 90% of AAM's advertising is for RC products. How many newcomers to this hobby get a good exposure to FF and CL? Probably, they never will. Free flight is enjoyed by a person who just simply loves light-weight, graceful, sometimes tiny, models. He is not tempted by RC or CL. On the other hand, the control line flier is often a person who would like very much to get into RC but does not want to risk it and can't yet afford it. Others like CL and enjoy it because it is not as "involved" as RC. Let's also remember that well over 60% of the AMA membership is RC oriented. Based only on statistics we could be getting the wrong idea on relative strengths of RC, FF and CL. I suspect that most FF and CL enthusiasts don't associate with magazines, groups, or national organization. They "do their own thing" alone and like it. The quantities of FF and CL merchandise sold each year suggest many more active modelers in these categories than in RC.

CLUB AFFILIATION

Not at all surprising is the large number of AMA members. Subscribers and members always respond to surveys more than newsstand buyers, so with AMA receiving 29,407 of the 129,475 copies printed, it is no wonder the AMA polled 51% of the readership. A notable number of modelers are also EAA members. Remember, most of the AMA members are members of local clubs, too.

HOBBY SHOWS

What's important here is not what shows modelers attend but the very obvious fact that modelers do attend

(Continued on page 91)

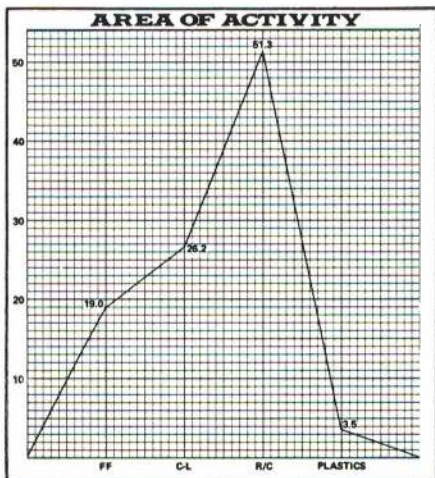

Hobby Shack

taipan



19R/C SCHNEURLE
\$29.95 ... SALE ... \$23.88
19 STD. SCHNEURLE
\$18.95 ... SALE ... \$14.88
15RC
\$24.95 ... SALE ... \$19.96
15 STANDARD
\$15.95 ... SALE ... \$12.76
15 DIESEL
\$28.95 ... SALE ... \$22.76
09 DIESEL
\$16.95 ... SALE ... \$13.67

BLUE MAX MK II IC 6 CHANNEL SEMI KIT With 4 Factory Assembled Servos

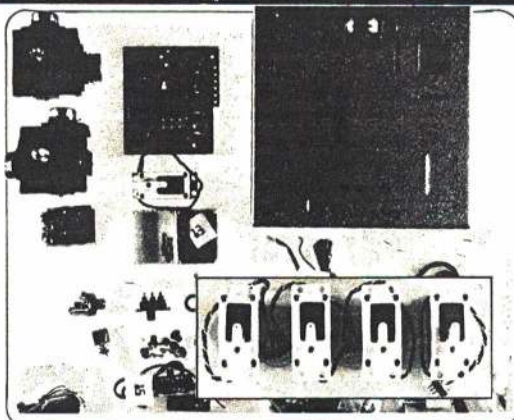

World Engines SEMI-KIT of the famous BLUE MAX MK II IC Series with only interwiring left for you to do, and some basic construction, now featuring 4 factory assembled servos (RS-5)

Discount
\$173.00

MUFF-L-AIRE NEW DUBRO



The New neater looking and contest proven DuBro muffer for the Webra .60 No. MW-750 retail \$7.50 Model MU-7.95 fits a variety engine sizes. retail \$7.95

\$6.29

\$6.66

NEW TAIWAN U/C \$1.75 CONTROL REEL

A 5" flying handle complete with lead out wires that you attach flying lines to. To adjust line, simple loosen the wing nut and move lead out, and then secure by tightening. Made of molded plastic for engines up .29. The practical flying handle we've seen!

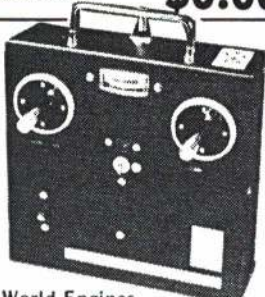
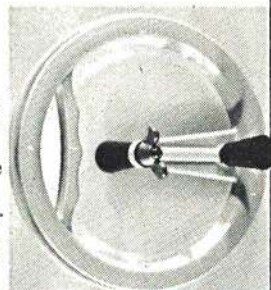

World Engines
6 CHANNEL BLUE MAX
MK II IC ASSEMBLED ...
Complete with r RS-5 mini servos, Ni-Cads, charger, and switch harness. **\$225.00**

C.O.D. Odering
(714)
522-4921

Call This Number For The
Fastest, Easiest Way To Order
From The HOBBY SHACK!

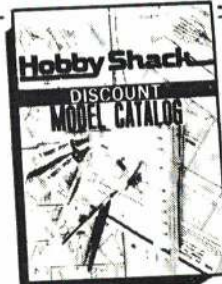

Hobby Shack CATALOG

FULLY ILLUSTRATED
PAGES OF R/C PLANES,
R/Control SETS, PARTS,
ACCESSORIES AND SUP-
PLIES, PLUS MODEL
BOATING SECTIONS &
GAS POWERED ENGINES

I enclose \$1.00 for your fully illustrated modelers catalog. Please rush it to me today!

MAIL THIS COUPON TODAY; TO:
HOBBY SHACK
6475 KNOTT AVENUE
BUENA PARK, CALIFORNIA 90620

NAME _____
ADDRESS _____
CITY _____
STATE _____ ZIP _____

POSTAGE & HANDLING

Orders to \$ 5.00 add \$.90
\$ 5.01 to \$ 8.00 add \$1.00
\$ 8.01 to \$15.00 add \$1.20
\$15.01 to \$20.00 add \$1.60
\$20.01 to \$30.00 add \$2.50
\$30.01 to \$50.00 add \$2.75
Any Order
Over \$50.00 add \$3.00

ON THE SCENE

THE NEW CHARLES RIVER RADIO CONTROLLERS FLYING SITE.

LORELEI SNYDER

After impatiently awaiting the third cutting of the newly seeded 400 x 250 ft. field, the 110 members of the Charles River Radio Controllers moved onto their new flying site at Callahan State Park, Framingham, Massachusetts, in late July. Even now, those members who insisted for three years it would never happen are still pinching themselves.

Success hasn't come without some blood, a lot of sweat and possibly some unadmitted tears of frustration. In the spring of 1969, CRRCer Al Nau, a Framingham policeman, alerted the Club to the state's acquisition of a new park site and suggested there might be room in the plans for a flying field. He and Al Bachand began hounding the local politicians; nothing came of it but promises of "something next week."

While awaiting "next week," Bachand began collecting data on good flying sites around the country, paying particular attention to how clubs were

living at peace with their neighbors. Finally giving up on the local politicians, Bachand took his material directly to the State House. "Using all my sales training, I talked the secretary of the Commissioner of the Department of Natural Resources into letting me see the man for just ten minutes."

Those ten minutes proved to be critical for the Club. Bachand came away with an invitation to return with a plan. He asked fellow CRRCer Ed Baum, an MIT architect, to prepare site plans for the 28-acre flying field and find it a place in the master plan of the 550-acre park which will eventually include golfing, picnicking, horses and a water fowl pond.

"We had to educate the state as to what modeling was and also how much control we had over our members. We had to convince them we were not like the irresponsible mini-bikers and snowmobilers who have continually torn up the fields," Bachand said.

The permit was finally signed this past January. Anyone in the state with an FCC and AMA license may fly at the park as long as he follows the rules posted at the field. The CRRC Club voted a voluntary assessment of \$25 to develop the site, and about 60 percent of the membership responded.

"Even the Juniors have asked us what they can do to help," Club President Russ Davis said. Members have also volunteered their talents. Two owners of 48" mowers have volunteered to keep the field cut, and a dozen others have said they would take a day mowing.

Plans for the future include black-topped runways, parking lot, grandstand and sanitary facilities. Next year the state has promised a concessioner's permit which will allow the club to collect user fees similar to ski areas, and the money will be put toward field improvements. In the meantime the Club is asking for voluntary donations.

While waiting for the grass to grow last June, the Club went all out to promote modeling as a responsible, healthy and skillful hobby with three exhibitions in as many weeks. For the second year, CRRC held an all-day air show, static display and kids contest at one of the Boston area's largest shopping centers, from which they netted \$150 from the center management. Gratis, CRRC joined the USAF Thunderbirds at Hanscom Field in Bedford, Massachusetts the next weekend for another demo; the following weekend they showed up at Dover-Sherborn Regional High School at the request of the Dover Youth Center.

"We're still in the development stage," Davis reminds everyone. But he adds: "Things have gone very well so far."

Al Bachand, who over the past three years has visited the State House on the average of twice a month to bring the field into existence, adds one very important thought:

"You have to keep a very positive attitude."



(1)



(2)



(3)



(4)



(5)

(1) CRRC static display at Shopper's World parking lot. (2) Shopping carts full of Sleek Streaks and two anxious contestants. (3) Dave Coraccio's biplane heads for the clouds while the crowd looks on. (4) Miss CRRC with trophy winner Dick Desimone. In background is Russ Manette, flight director of rubber band contest. (5) Bill Landry (rear) and Dick Mayer ready Landry's Formula 1 Midget Mustang for a brief exhibition run at the Charles River Radio Controllers' June 3 air show at Shopper's World in Framingham, Massachusetts. The shopping center contributed \$150 to the Club to be used in developing newly acquired flying site. (6) President Russ Davis and Treasurer Jim Peghini, flanked by two youthful bicyclers who dropped in at the new flying field, explain the RC bit. It's 400 ft. to the shallow tree line; the embankment beyond is a hay field.



Photos by Lorelei Snyder

Quiet Beauty ... with Dumas Scale Models

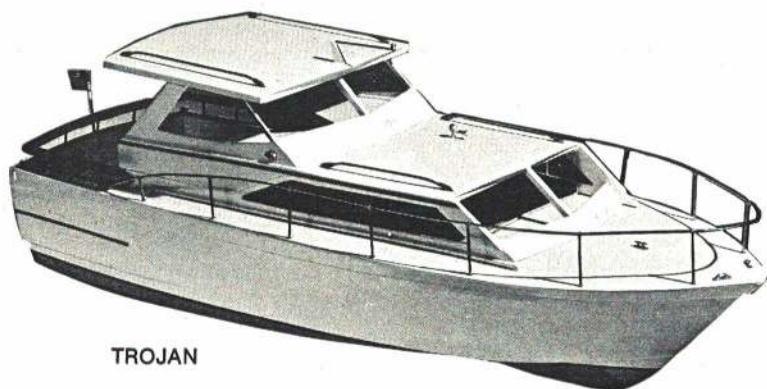

TROJAN

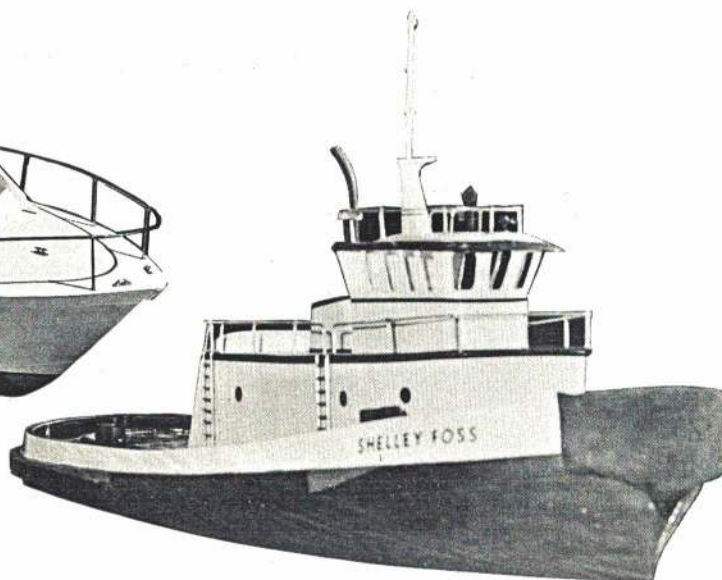

TUGBOAT

... and the accessories too!



PT 109

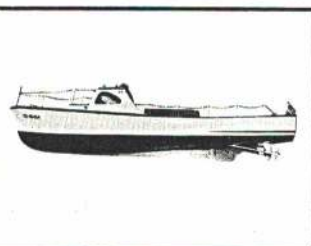

COAST GUARD BOAT



SPORT FISHERMAN



DUMAS/PITTMAN MOTOR

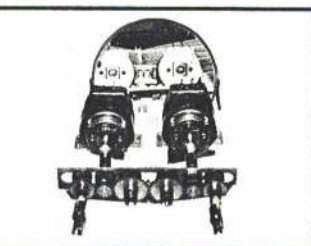

ADAPTADRIVE

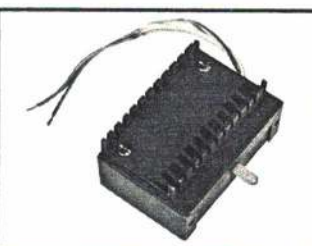

SPEED CONTROL

Whether you're a display model builder, a RC scale fan or want something for free running, here are two brand new models of brand new boats. The Trojan 31' yacht model is in 1" to 1' scale right off the plans of the full size boat. Tough plywood construction allows installation of single or dual Dumas/Pittman motors, an adaptadrive unit, even a .19 to .35 engine ... plenty of room for radio gear and batteries too! Then there's our new 90' tug model ... also right off the full size plans of the latest type tugs, but scaled down to 36". The famous 33" PT 109 with all mahogany construction, for electric or gas

power; our two popular balsa kits; the 29" Coast Guard 40' utility boat and 1" to 1' scale Chris-Craft 35' Sport Fisherman for electric power or display round out our most popular models. Our complete line of hardware: props, shafts, stuffing boxes, rudders, steering arms, and universals are available for gas engines or the Dumas/Pittman electric motors. The Adaptadrive transmission unit combines with our brand new proportional speed and direction control unit to provide all you need for operation of your electric model. Send 25¢, to cover postage and handling, for complete catalog.

**dumas
boats**

Dumas Products, Inc., 790 S. Park Avenue, Tucson, Arizona 85716



PART I

ORBIT'S CUSTOM SIX-CHANNEL SINGLE STICK WITH THE ROBUST PS6 SERVO.

FRED MARKS

You could say that the set tested this month has undergone two years of testing without stretching the point too much. The 1970 Orbit set was the first serious Blue Ribbon Review done by the author. I purchased that set and have flown it about every session in just one airplane—the R/C Nobler originally presented in AAM. It seems in order to point out that the authors of Blue Ribbon Reviews receive payment from AAM for the reviews, they do not receive equipment. Personally, I think this adds to the objectivity. It would be pretty hard to criticize equipment received gratis from a manufacturer who is also an advertiser!

That original set has suffered only one failure in two and one half years. One cell in the battery pack failed at the moment a snap roll in vertical flight was being performed. Spectacular!

Much has happened at Orbit since that time. Bob Dunham, the founder of Orbit, sold the business to Datatron, Inc. which also purchased Micro Avionics. After two years, Datatron sold Orbit Electronics to Charles Speer, a business management consultant. Speer has proceeded rapidly to revitalize Orbit, reexpand its line of products and, I think most importantly, to bring service back to the level it belongs. Orbit has "laid it on the line" so to speak by offering a 90-day warranty on repairs. In other words, if a set is repaired and then suffers the same failure within 90 days, that repair will be without charge.

The set tested this month is a single-stick, six channel set. (The 1969 set mentioned above has a two-stick transmitter.) Physically, the new set shares much in common with the earlier set. Receiver case style is the same: vinyl covered aluminum with the receiver board retained by slots in the ends of the bottom half of the case. The servos

(Continued on page 82)

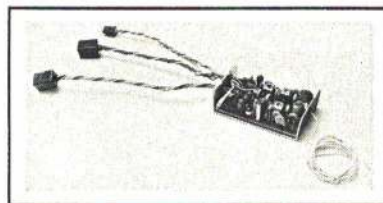
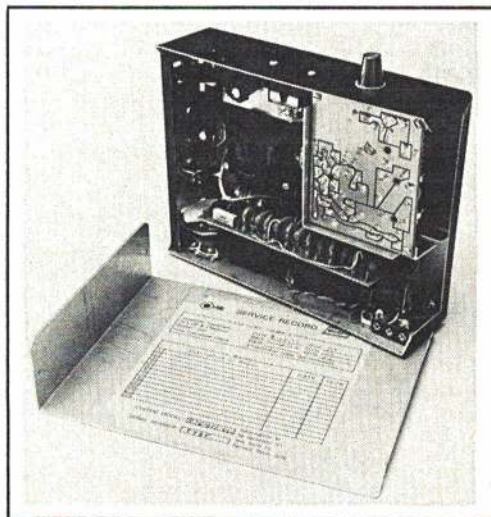
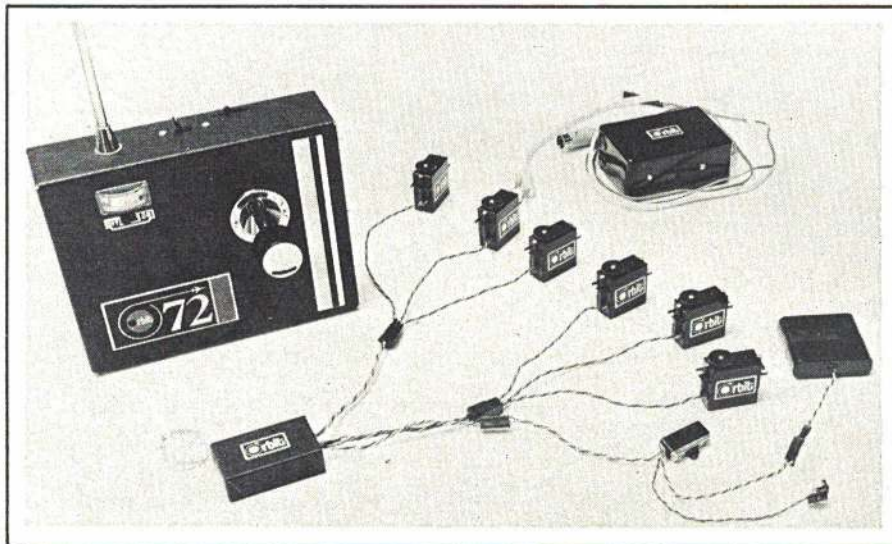

Top: In addition to the above parts, the Custom systems also include all servo trays, frequency flag, an excellent instruction manual, and plenty of servo output arms. Above: New Orbit single deck receiver. It now operates at full range between 4.8V down to 3.6V. A one-cell battery failure is not a guaranteed disaster as in the past. Left: New feature in the transmitter is the attached service record card. The technician who does the work also signs the card. This speeds service and assures quality work. Below: Workshop effort on the Intruder is finished—now for some flying.

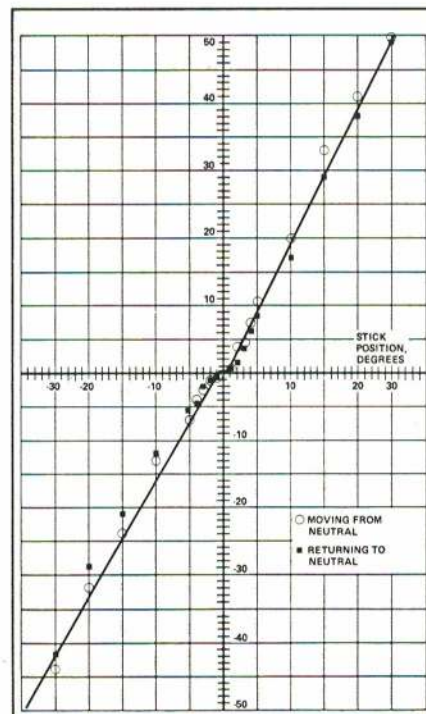



Holiday Offer

Plans and designs of all kinds. Great technical features. Full-scale articles and drawings. Enough Radio Control for the most ardent hobbyist. How-to-do-it articles and drawings for the TENDERFOOT. And WHERE THE ACTION IS covers the latest tricks, hints and kinks in free-flight, radio control and control line.

All this and more delivered to your door monthly at the low-low holiday price—if you subscribe now.

USE HANDY ENVELOPE—IT'S ALREADY ADDRESSED TO US—NO STAMP NECESSARY

Gift Announcement

SENT IN YOUR NAME

Be sure to print your name as donor on the envelope. We will immediately send an attractive gift announcement to the person you designate.

And a Merry Christmas to you too.

THE BIGGEST BARGAIN!
our new price of \$9.00 means a savings of **\$3.00** by acting now!

ONE YEAR
12 BIG ISSUES
FOR ONLY—

\$6.00



SAVE \$6.00 OFF
NEWSSTAND

SAVE \$3.00 OFF
REGULAR PRICE



PART II

SKYGLAS KIT OF KIRKLAND'S A6 INTRUDER. AUTHOR LIKES IT SO MUCH HE'S MADE THREE.

VAN HIGHERS

It has really been a pleasure to build (assemble) the A-6 kit and to fly the airplane. It looks like Jim Kirkland has hit upon a winning airplane. The kit comes in five pieces. They are the fiberglass fuselage and two wing halves and the stabilizer halves. My fuselage weighed in at 21 3/4 oz. When the kit arrived, I made up a list of materials that would be needed to finish the airplane. It took about fifteen dollars worth of wood and accessories to finish the airplane. The A-6 in the pictures is finished off with silk and dope. Mine turned out a little heavy. Eight lb. and four oz. empty (no fuel). The G-60 Supertigre on Missile Mist will really haul this airplane around the sky.

The cores were covered with 1/16" balsa. I mixed some red cake coloring in the Weldwood water-based contact cement and then applied the glue to the cores and covering sheets. By using the coloring, I could see where the cement was too heavy or too light. After the cores were covered, I made a wing jig to get the proper dihedral angle. The plans that came with the kit do not specify the dihedral information. Kirkland recommends 11/16" under each wing tip measured from the skin to your work surface.

The stabilizer cutout in the fiberglass fuselage was made with a cut-off disc on a Moto-tool. To get proper alignment of the stabilizer, I blocked up the fuselage with a 24-in. straightedge through the wing saddle. Then I could measure the vertical distance to each tip of the straight edge to get it level with the table. This would ultimately give me a level stabilizer when placed in the fuselage. Measure the stabilizer tips, then block in place and epoxy in place on the bottom side. After the bottom side was epoxied in, I epoxied the top of the fuselage, aligning the fin vertically at the same time.

The wing joint was made with epoxy. A four-in. wide band, top and bottom, of fiberglass tape was laid up with epoxy to secure strength in the center section. The wing was bolted in place with nylon bolts and 3/8 dowels in the leading edge. After installing the wing, the belly pan was taped in place and appropriate filler material was used to get the proper fit to the fuselage. The strip ailerons leave one with excess wood as they must be cut down from two-in. stock wood. To shape the ailerons fast, use a razor plane and the wood comes off easy. I glued mine in place and got the proper shape and then I used a coping saw to cut them loose. The leading edge shape is a half diamond, so there is a gapless fit at the wing trailing edge. The hinges were inset into the ailerons for a gapless fit. To get this airplane to roll properly the ailerons must be a close fit, but free. I insure a gapless fit by using Scotch tape on the underside, full length of the ailerons. The clevises are at the top of the horns. This way if the roll rate is too extreme, start by removing a couple of inches of tape from both sides beginning at the inboard section and working outboard.

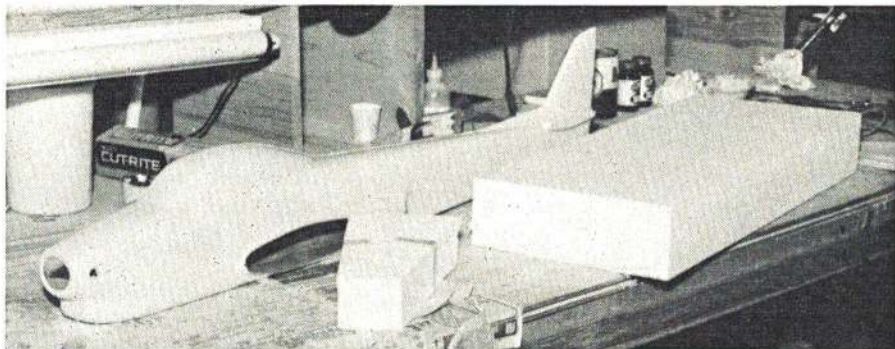

Top: The Intruder is typical of all SkyGlas kits. Finely-detailed and precision-joined fiberglass fuselage with foam wing and stab cores. Sides are actually joined while still in original molds and there's very little flash or gaps in the joints. Above left: Every builder has his pet materials. Van Highers strongly recommends Weldwood water-based contact cement for skinning wings and stab. The skinning job is about an evening's work. Above right: Spackling compound is great for filletting the joints of the tail surfaces with the fuselage. It sands easily, too. Left: The muscle up front is a Blue-head Supertigre 60 equipped with Perry carburetor and flow-through type muffler. Remember to balance the plane for the side-mounted engine. Below: Most fun part of all Blue Ribbon Reviews is flying. The Intruder is an excellent ship for a sport flier with a grass field. It even stunts nicely at half-throttle.

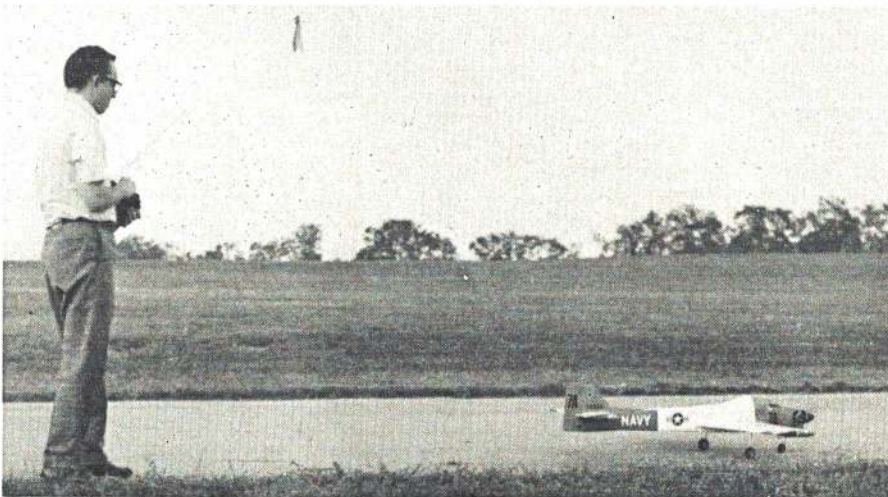

(Continued on page 86)



CARL GOLDBERG

NEW! CG LOW BOUNCE WHEELS

With SHARP, CLEAN RIB TREADS
and TOUGH, LONG-WEARING HUBS

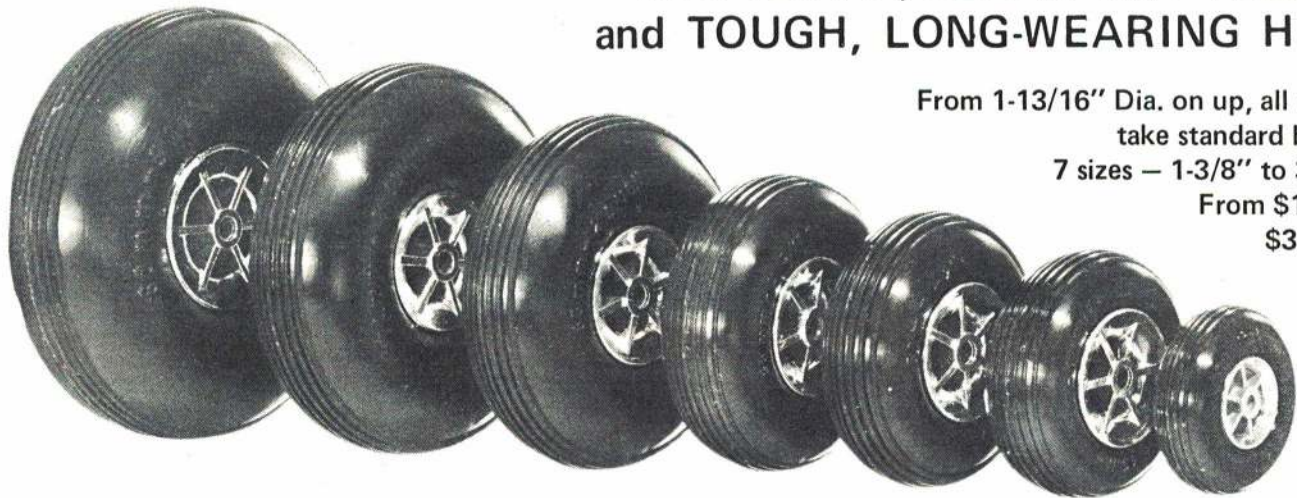

From 1-13/16" Dia. on up, all wheels
take standard brakes.
7 sizes — 1-3/8" to 3-1/8"
From \$1.89 to
\$3.19 pr.

Tested and proven in the field by famous fliers, we believe you, too,
will be well pleased by these very attractive new CG Low Bounce Wheels.
Ask your dealer to show you the size you want!

NEW! Spring Steel E-Z LINKS with 10" Rod

39¢ Each or 6 for \$2.25

New E-Z LINKS not only save you money, but are made of spring steel
and have quality threads that work smoothly without galling. The
rod hardness is just right, too — not too soft.

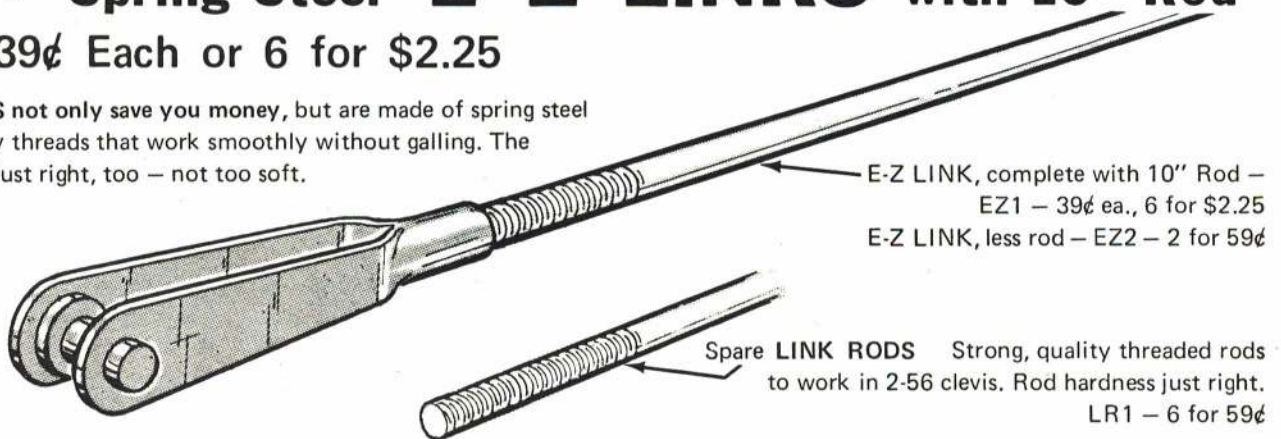

E-Z LINK, complete with 10" Rod —
EZ1 — 39¢ ea., 6 for \$2.25
E-Z LINK, less rod — EZ2 — 2 for 59¢

Spare LINK RODS Strong, quality threaded rods
to work in 2-56 clevis. Rod hardness just right.
LR1 — 6 for 59¢

NEW! Nylon TAILWHEEL BRACKET

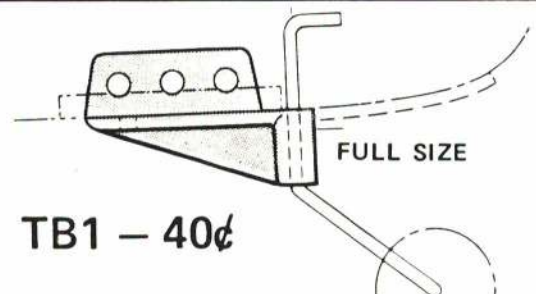
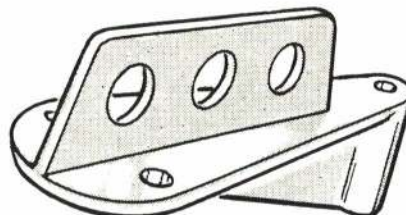

TB1 — 40¢

The simplest tailwheel mounting bracket yet — just cut
a slot in the rear bottom of the fuselage, smear epoxy
on the glue fin, and slide it into place.

AVAILABLE IN CANADA

P.S. For best service, see your dealer for items you
want. If not available, write direct; add 55¢ per item
(\$1 outside U.S.). Minimum order \$1.

CARL GOLDBERG MODELS INC.
2545 W. Cermak Rd., Chicago, Ill. 60608
I am sending 20¢ for 8 pg. Illustrated Catalog with "Recommendations in Starting in R/C," Basic Explanation of R/C Equipment, and Radio Control Definitions.

NAME _____
ADDRESS _____
CITY _____
STATE _____ ZIP _____

CARL GOLDBERG MODELS INC.
2545 WEST CERMAK ROAD • CHICAGO, ILLINOIS 60608

New Products Check List

FRANK PIERCE

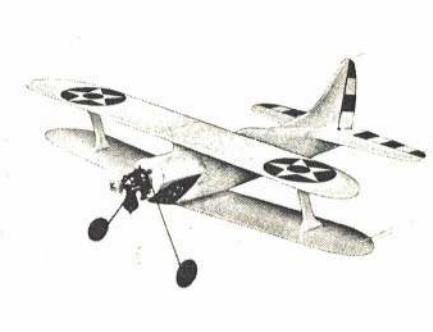
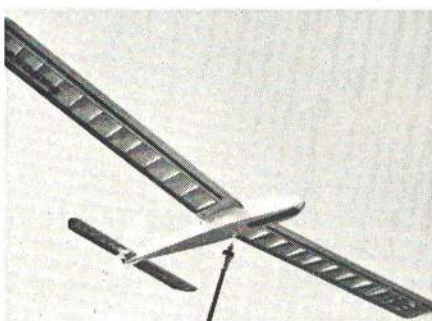
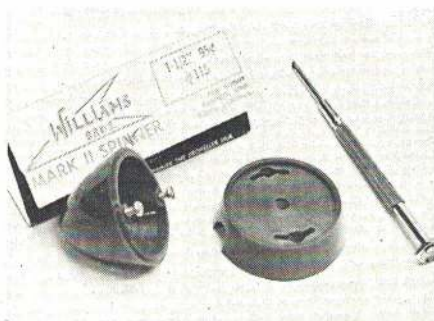
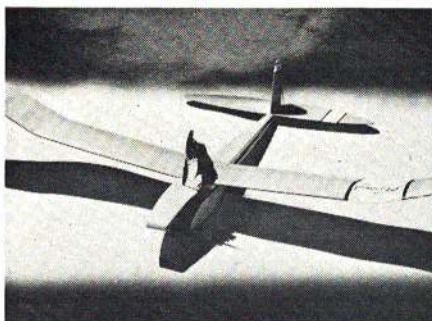

MRC/Single-stick four-channel system. Single-stick design with engine and rudder trim positioned for left-hand operation. Quick-change crystals (shown in packets) operate on all 27 MHz and all but one 72 MHz bands. Total airborne weight with four linear FP-S2 servos is 15.9 oz., only slightly more with -S2 rotaries. Available as F-723 system with 12 AA battery complement or as F-724 (shown) with external charger and NiCad batteries. Model Rectifier Corp., 2500 Woodbridge Ave., Edison, N.J. 08817

Williams Bros./Twist-Lock spinners. New design spinner uses two internal locking screws for convenient removal of spinner cap without tools. Comes in eight sizes from 1 1/2" (shown) to 3 1/2", six colors, priced from 95 cents to \$5.45. Big extra: No external "non-scale" screw holes. Also available is Williams Bros. illustrated catalog for 25 cents. Williams Bros., 181B St., San Marcos, Calif. 92069

Centuri/New rocket kits. New line of almost ready to fly rockets needs only installation of a few die-cut parts, application of decals. Conventional rockets plus unusual twin-boom Hummingbird. Priced from \$1.25 to \$2.50 for Excalibur-2 (center). Centuri Engineering, Box 1988, Phoenix, Ariz. 85001

Ace RC/Three new Ace Fun Fly kits. Available through Ace and other distributors, three new kits make use of Ace R/C equipment. Top: NOMAD, a resurrection of an old design which should be popular with beginners and advanced fliers. High wing, power pod for 020 engine, 42" built-up wing, plane is designed for Pulse Commander with Baby Twin actuator. By House of Balsa, 2814 E. 56th Way, Long Beach, Calif. 90805. Middle: QUESTOR, from the Airtronics Olympic series, has 62" span, 490 sq. in. surface, weighs 16 to 20 oz. all-up. From Airtronics, Box 132, Sierra Madre, Calif. 91024. Bottom: from Ace, EAA-inspired All-Star biplane using Ace foam taper wings. Kit operates on 049 to 15 power, depending on RC gear selected. Designed for single, 2- or 3-channel operation, plane has 34" span plus simplified cabane and N-struts for easy, exact construction and alignment. 60 precision-cut parts plus wings and wire parts, \$21.95. Ace R/C, Box 301, Higginsville, Mo. 64037

Murphy/Muffler. New quick-attach muffler reduces sound level 75% at 50 ft. on typical 40 engine. Easily installed spring mount, separates easily under stress, and adapts to many different designs without special fittings. No power loss. \$10.95. Production plans forthcoming. Murphy Muffler Co., 5312 E. Beverly Blvd., Los Angeles, Calif. 90022

Aerotrend/"Flyin' Box." Lightweight sturdy fiberglass is used for field kit case with drawers made of ABS plastic. Available in bright, molded-in red, orange, yellow, or blue. Adjustable locking plane-supports, four folding legs and built-in work surface. In kit form, requires only two or three hours assembly. Complete with postage \$44.45 from Aerotrend Products Co., Box 427, Seymour, Conn. 06483

Joy Products/Three new Simpli-kits. Ready to fly in three or four hours work, these inexpensive CL kits come with top grade balsa, all hardware including bellcrank, can fly well on 020 power, real performance on 049. Thunderbug, jet-inspired with wingtip tanks, Super Stunt-Runt biplane (shown) and Pee-Wee Pup monoplane, \$3.95 ea. from Joy Products Co., Box 374, Menominee Mich. 49858

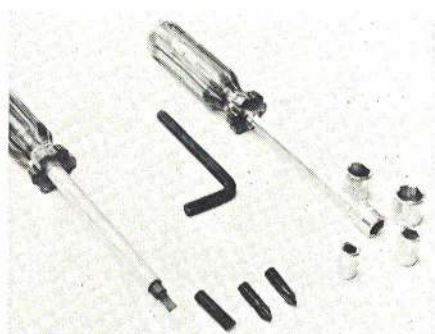
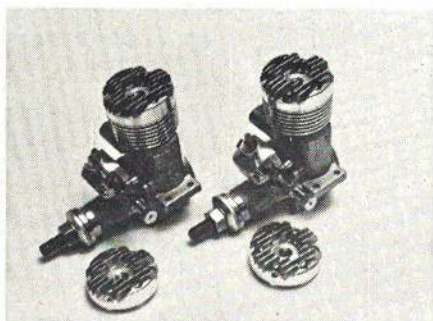
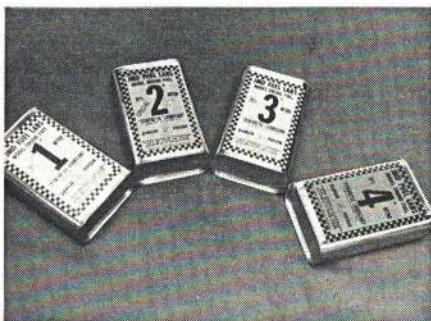
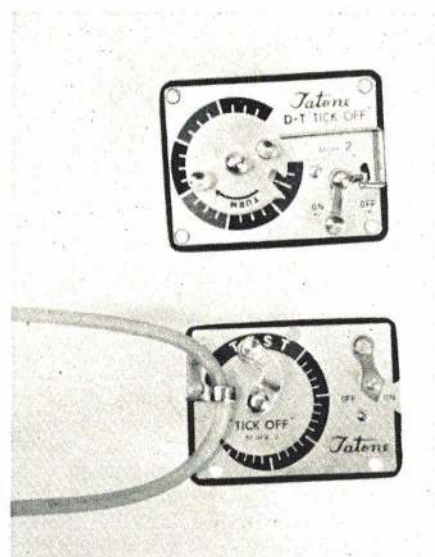
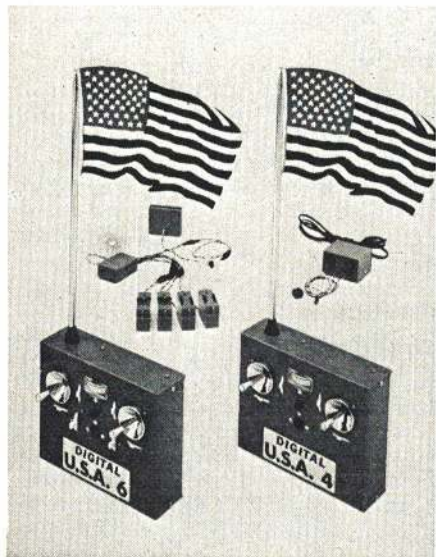

Hobby Capitol USA/Digital systems. Digital USA-6 and -4 are low-priced systems with linear or rotary servos. Nicad batteries, operation on 27 or 72 MHz. Equipment manufactured with EK-logic control components. Price including external charger is \$175 for -4, and \$200 for the -6. Hobby Capitol USA, 903 Church St., Nashville, Tenn. 37203

JMD Fuel Labs/Nitro fuel. In quart and gallon cans, color-coded according to nitro content. Numbers 1, 2, 3, and 4 contain 5, 10, 25, 35% nitro respectively. Contains no castor oil. Quality control in all steps of manufacture, comes with batch number on back of can. Prices range from \$1.70 to \$2.25 for quarts, and \$5.80 to \$7.10 for gallon cans. JMD Fuel Labs, P. O. Box 235, North Olmstead, Ohio 44070

Sullivan Products/Fuel pump. Operates on 12-volt supply, heavy-duty pump will move one oz. of fuel per second, reverses by changing polarity. Gear-type pump, constant-displacement. Accessories include 100-mesh filter, heavy-duty switch, alligator-type terminal clips, nylon filler tip for tank, all necessary tubing and hook-up wire. Complete, \$11.95. Sullivan Products Inc., 535 Davisville Rd., Willow Grove, Pa. 19090

Dremel/Catalog. Fully illustrated 12-page catalog lists a vast assortment of Dremel tools and equipment of interest to any serious modeler. Moto-Tools, Moto-Shop, engravers, tool attachments, much more. No charge. Write Dremel Mfg. Co., 4915 21st., Racine, Wisc. 53406

MRC/Two new Enyas. Both 29 and 35 Enyas boast a 10% increase in power through redesigned intake porting without sacrifice of easy starting. Throttles and venturi inserts have also been redesigned for easier maintenance and replacement. 29 IV-TV, \$23.93; 29-IV, \$19.98; 35 III-TV, \$25.50; 35-III, \$21.50. Model Rectifier Corp., 2500 Woodbridge Ave., Edison, N.J. 08817

Krd Products/Epoxy spatula. Use it for mixing and applying any kind of epoxy. When dry old epoxy can be scraped easily and cleanly off spatula. Re-use again and again. Get smart. Stop using your wife's good silver butter knife for spreading epoxy. Go the Krd way! Five for 49 cents. Krd Products, Box 3391, Shawnee, Kan. 66203

Tatone Products/Two timers. Again available, two quality timers for FF. 3/4-oz. Tick-Off timer runs up to 30 seconds, squeezes off fuel supply in surgical tube at end of run. 7/8-oz. DT Tick-Off timer runs out to six min., then operates dethermalizer. \$5.75 ea. Tatone Products, 1209 Geneva Ave., San Francisco, Calif. 94112

SuKarTa/Quick-disconnect antenna connector. "Shove-it" is a simple approach to a cleaner aircraft. Allows a permanent internal antenna installation in two or three aircraft while interchanging your receivers. Gold-plated contacts for flawless connection, doesn't de-tune your receiver. \$1.29. SuKarTa, 51 Hawthorne Ave., Park Ridge, N.J. 07656

Vaco/12-piece tool set. Compact set is ideal for most in-the-field needs, takes up minimum space in modeler's field kit. Basic socket wrench and screwdriver take a variety of magnetically-attached tips: 1/4, 5/16, 7/16, 1/2" sockets, 3/16 and 9/32" slot-screwdriver, and Phillips 1 and 2. This plus 1/4" hex head wrench, \$5.95. Vaco Oriducts Co., 510 N. Dearborn St., Chicago, Ill. 60610

THE SOUND OF THINGS TO COME

ELECTRIC POWER IS HERE NOW.

JACK HEADLEY

The Royal Aeronautical Society published a series of papers under the general heading of "Looking Ahead in Aeronautics" during the late 1960s. These papers authored by some of the world's experts in the aeronautical art covered a wide range of topics regarding what aviation is going to be like in the next hundred years. In one of the papers B. S. Shenstone discussed what's going to happen to "Unconventional Flight" by which he meant gliders, sailing boats, man-powered aircraft, and in addition model airplanes. This surprised and delighted me, as models rarely make their appearance in "serious" literature. One sentence in particular interested me: "The need for an entirely different source of power and fuel may not be fully realized at present, but such a unit and the aerodynamics and structure to match is bound to come." When I read this in 1968 I couldn't see why we would need a new power source. What could be wrong with the old glow motor?

Well, here it is 1972, and there are quite a few people ready to tell us what's wrong with the old glow motor. For some reason the sound of a control-line model buzzing around is greatly disturbing to the majority of the population, who are otherwise deaf to lawnmower engines, helicopters, minibikes and the like. In short, we produce too much "noise pollution."

How does this model specification fit Shenstone's requirements? (1) Different source of power—electric motor. (2) Fuel—instantly rechargeable battery. (3) New structure—foam wing and tail, plastic body. (4) Noise level—None (almost).

Does such a thing exist? Yes, in fact there are two of them. One is an RC model, and the other is a free flight called the "Superstar," both now available from Mattel and both powered by electric motor units.

We'll concentrate on these electric motor units, in particular the smaller one from the "Superstar," but the suggestions will be applicable to both units. But this shouldn't be looked on as just another motor type; it is actually a means of bringing back flying from the outer boondocks to the local park, or even our own backyard. In one stroke of genius one of the major drawbacks of modern aeromodeling, the noise problem, has been eliminated. Thanks to Mr. Mattel, we are now able to fly around the local neighborhood, rather than drive for hours to find a place to do a little free flighting.

Without too much divination, we can see the following immediate applications for the electric motor power unit.

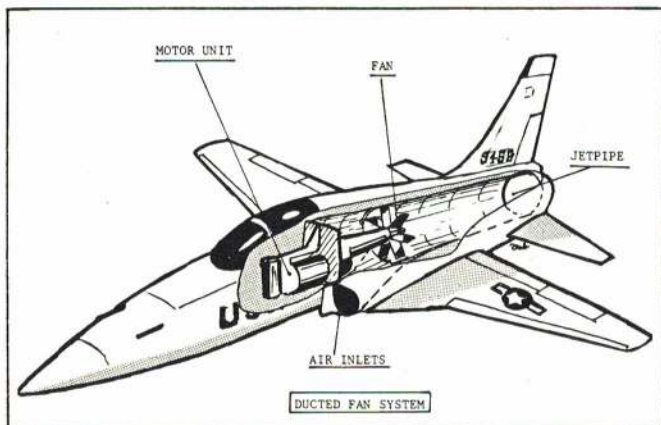

SCALE MODELS

Nothing sounds less scale-like than a beautifully built scale model powered by a small glow motor running at about 20,000 rpm. And nothing is more frustrating than trying to start a small diesel motor that's fully cowled in a scale ship, so here we have the perfect power unit for the scale model. Possibly the quietness won't sound scale-like either, so we could add a little noisemaker to the engine to correctly simulate the true sound!

More seriously, other applications could be for long nosed models. Here it should be relatively easy to replace the existing motor shaft with a longer one, thus keeping the motor over the CG. Our sketch of the Far Out Fighter illustrates this idea.

For pusher models simply reverse the battery leads, put the prop on backwards, and away you go.

DUCTED FANS

See the remarks about starting fully cowled engines in scale models and double them for ducted fans. Here's the ideal application for the electric motor, just switch it on and it runs. For this application the motor unit should be put in backwards, and a "left-handed fan" will be required. The sketch shows a possible installation.

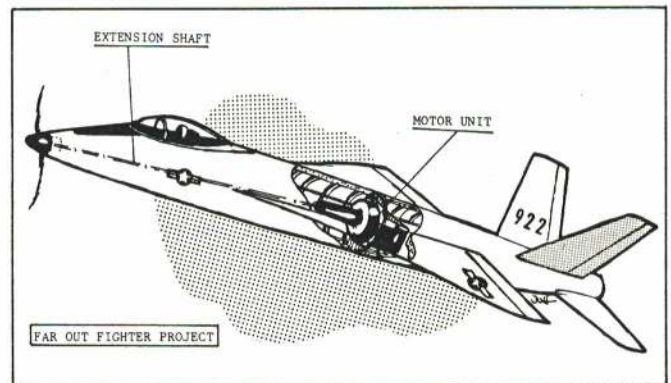

AUXILIARY POWER UNIT FOR RC GLIDERS

Gliders can often be flown in populated areas, mainly because of their "noiselessness," and use of the conventional strap-on 049 motor for calm days is usually not too practical, so why not an electric power pod—at least it won't bring all the neighbors running. The sketch shows one possibility, a nose mount rather than the usual over-the-wing system is preferred because of the prop diameter. But, no goop on the model and no necessity to fuelproof same. Bigger batteries will also give more duration.

MULTI-ENGINE FREE FLIGHT MODELS

By far the biggest problem in multi-engined models is that of keeping all the motors running evenly, and having them all stop at the same time. No longer. Run all the motors from a common battery pack; switch on and all props are spinning, the batteries run out and all the props stop at the same time—fabulous. Now for less than \$30 you could probably build a free flight B-17 and get more than one flight out of it.

No need to sketch ideas here, they come too readily to mind. Now, with 12 motors I could finally make that Dornier Do.X and then maybe that. . .

And lots more, it doesn't take too long to think of all sorts of exciting applications. You've probably thought of two or three others while reading all this. So let's cash in on this fabulous possibility—it's not too expensive either. Our local discount house sells the complete "Superstar" package (that's model plus motor) for around \$7, cheaper than most glow motors these days. So buy one or two and try silent flying—it's fun.

But just in case you haven't run across one of these motors yet, we've made a sketch showing the various components. This is the standard unit, just as fitted to the "Superstar." It doesn't take too much imagination to see that a much lighter and more compact unit could be made.

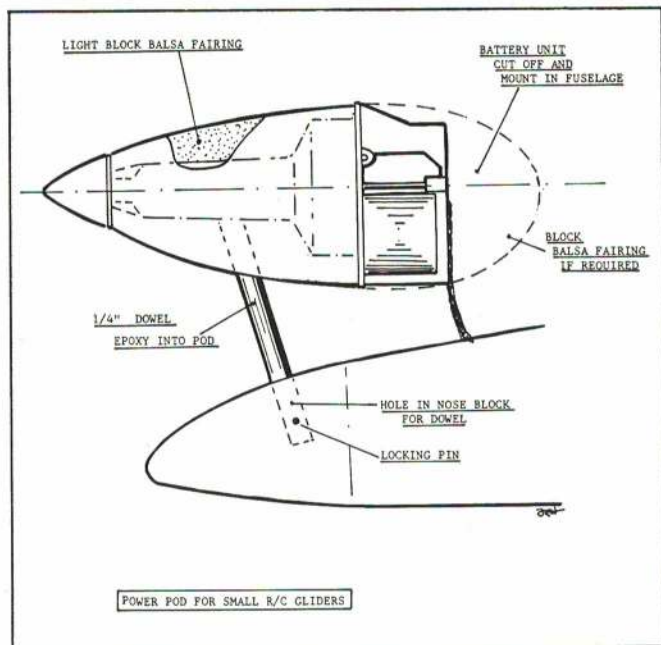

MOTOR UNIT MODIFICATIONS

Probably the first item we can delete is the small gear box used with the cam rudder control, and then after this, the batteries can be relocated, either above the motor, or in a separate package, which means adding a couple of about 16-18 gauge connecting wires.

Another possibility is to increase the length of the motor run by adding a further pair of batteries in parallel with the first set.

We've mentioned the extension shaft already for use with long nosed models, so the opposite approach for stubby nosed models like the Sopwith Camel would be to shorten the prop shaft. This would mean cutting the plastic support structure and remaking the forward bearing, but this should be easily done.

In short, we can see that all types of modifications are

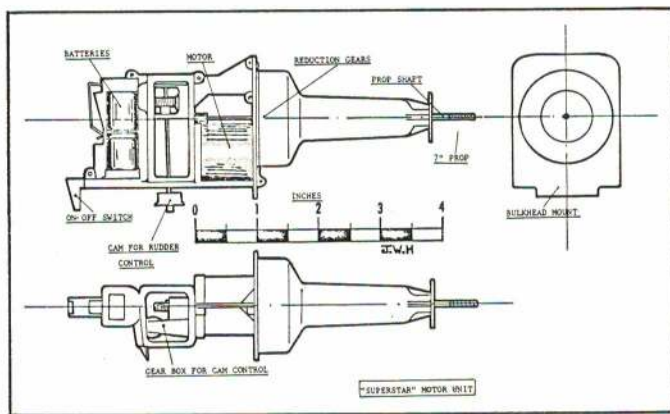

possible and these can be accomplished using only a few hand tools.

A final suggestion is to fit a freewheeling propellor. Any of the well-known rubber model type freewheelers should work here. The one we prefer is the "one-way" clutch type.

MODEL SIZES

So far we made two original electric models, plus another converted from a large rubber scale model, and flying these plus the original "Superstar" has given us a good first shot at sizing electric-powered airplanes. The two originals (both called Vampires, although they were different designs) were around three-ft. wingspan, which seems about optimum. These models had a good fast climb, followed by a reasonable glide. The converted rubber model however, had almost no climb, with a ceiling of about 10 to 15 ft., but this had a wingspan of just over four ft. So 36" to 40" looks about right for the span, with not too heavy construction.

CONCLUDING REMARKS

Electric models are a lot of fun to fly, and in these days of instant everything, give instant flight. Contest flying is undoubtedly not far away, and indeed as this was being written we received word that the 1972 "Flightmasters" Annual Scale Contest would have a class for electric-powered free flight scale. So why not try electric flying, you'll like it.

As anyone who's done a little slope soaring knows, there are times when, after hauling all the equipment to the top of the local lump, the wind, which has been blowing steadily for days, ceases as soon as the model is assembled. Maybe Mother Nature is upset because I eat too much margarine or something, but it does seem to happen to me quite often. So what can we do about this? Up to now my solution has been to sit around on the top of the hill complaining, but this

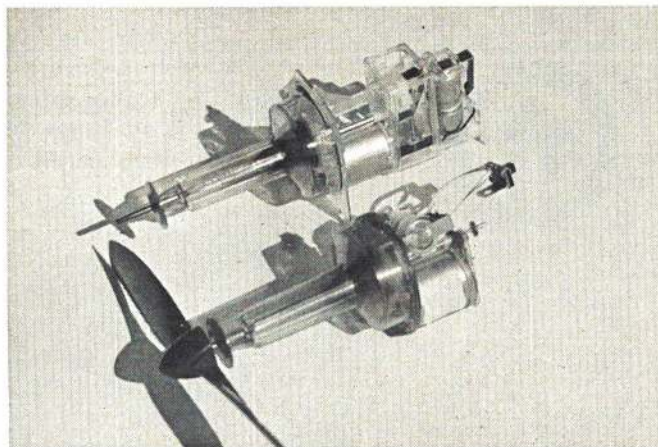

Original and modified motor units.

On the "Capstan" test bed.



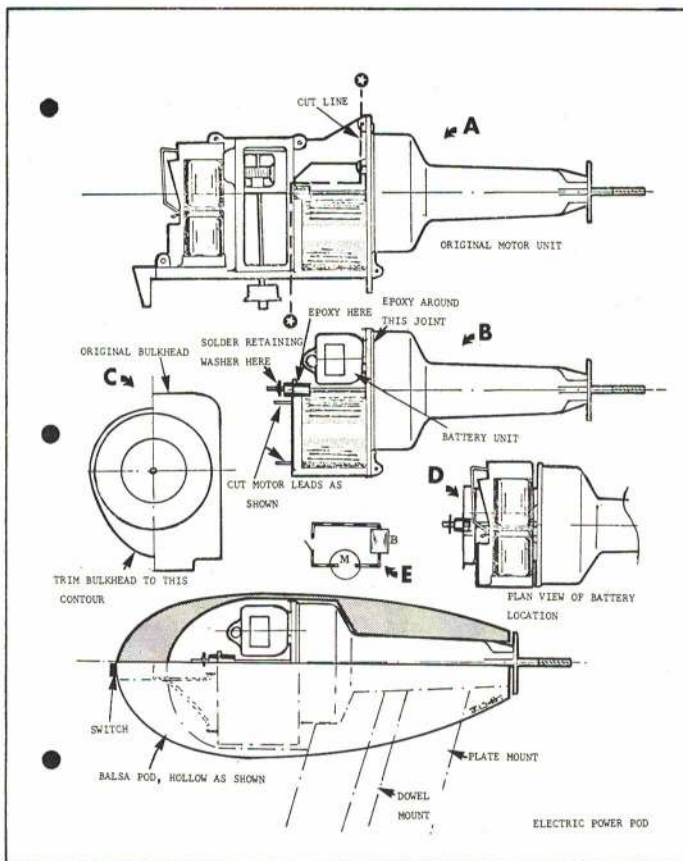

doesn't get much flying done, so I decided to make a power pod for just these occasions. So what, you say, power pods have been around since Pontius was a pilot. Ho-ho, sez I, but not my non-polluting, non-oily, silent electric type power pod. Made from a Mattel free-flight model power unit, it's easily constructed and can be kept in a corner of the model box for just those days. Want to make one? The following step by step instructions show how to convert the Mattel unit into a Mother Nature beater.

- (1) Cut off the gear box-battery assembly from the motor unit (Fig. A).
- (2) Cut the motor leads about 1/4" aft of the motor.
- (3) Trim off the rear bearing to a small cylinder.
- (4) Epoxy this bearing to the frame, and also run a bead of epoxy around the front bell housing (Fig. B).
- (5) Trim the bulkhead to an oval shape (Fig. C).
- (6) Solder a retaining washer to the big gear shaft (Fig. B).
- (7) Trim the battery carrier as shown (Fig. D), removing the slide switch in the process. Affix the batteries to the carrier with masking tape.
- (8) Solder a pair of wires to the battery, motor, and a new slide switch (Fig. E).
- (9) Make up the balsa pod and insert the motor. The pod is split horizontally for this purpose and is held together with a couple of rubber bands.
- (10) Pod mounting is optional, the sketch shows both a dowel type mount and a plywood plate, so take your pick.

Charging the batteries is accomplished in the original way. The total weight of the original pod plus motor unit came out to be three ounces.

Editor's Note: Several issues hence AAM will present a major article by Bob Meuser in which he reviews the many electric power systems now being offered to modelers. This will include technical data, information on weights, power duration, battery requirements and charging systems.



TOWER HOBBIES

P.O. BOX 2874 STATION A • CHAMPAIGN, ILLINOIS 61820

JANUARY SPECIALS

RC KITS: MARK'S Windward Glider \$18.00, Windfree Glider \$23.50; MACO Jet Star \$34.00; AIRTRONICS Olympic 88-99 \$28.50, Mini-Olympic \$17.50; ANDREWS Mini-master \$21.50, Trainermaster \$24.50, Sportmaster \$30.75; BRIDI Kaos \$39.80, RCM Trainer \$35.95, RCM Basic Trainer \$20.75; JOHNNIE CASBURN Super Lucky Fly \$47.50; DUMAS Hi-Pro Glider \$29.95; GOLDBERG Ranger 42 ARF, Falcon 56 \$13.95, Skylane 62, Sr. Falcon \$25.50, Skylark 56 \$16.75; GRAUPNER Kwik Fli III \$41.00, Middle Stick \$31.00, Cirrus Glider \$39.00, Cumulus Glider \$92.50; JENSEN Das Ugly Stick \$39.00; LANIER Invader \$44.95, Jester \$42.75; MIDWEST Cessna Cardinal ARF \$15.95, Ez Juan Glider \$20.95, Das Little Stick \$16.25; STERLING Fledgling \$18.50, Lancer \$19.95, Schweizer 1-34 \$20.95, 1-26 \$14.95; TOP FLITE P-51 Mustang \$30.00, P-40 Warhawk \$33.50; VK Navajo, Cherokee \$27.75, Cherokee Babe \$19.75, Nieuport 17 \$31.50, Fokker Triplane \$34.00

RC ENGINES: ENYA .09 \$12.45, .15 \$13.75, .19 \$15.75, .19 BB \$25.50, .29 \$18.25, .29 BB \$23.25, .35 \$19.50, .35 BB \$22.95, .45 BB \$31.00; FOX .15 \$12.00, .25 \$14.25, .36 \$16.50, .40 \$18.00, .60 Eagle \$34.75; HP .61 Bluehead w/muffler \$55.95, .40 FR w/muffler \$39.25; K&B .40 \$25.75; VECO .19 \$20.75, .61 w/Perry and muffler \$52.50; NORTHFIELD-ROSS Std Aluminum Twin \$106.00, Black anodized Twin \$124.00; OS MAX .10 \$12.75, .20 \$18.25, .25 \$19.75, .30 \$20.50, .35 \$20.50, .50 \$31.50, .60 Goldhead \$43.50, .30 Wankel \$70.00; SUPERTIGRE G 21/29 RV ABC \$27.00, .51 \$28.25, .60 \$35.25, .60 Bluehead \$44.75; WEBRA .40 Blackhead \$45.00, .61 Blackhead \$60.50, .61 Blackhead Marine \$84.00

RC ACCESSORIES: POLYTHERM Heat Gun \$28.00; SEALECTOR Sealing Iron \$10.95; ROBART Super Shoe \$2.25, Hinge Points (6) \$.75, (15) \$1.55, Drill Jig \$2.25; DUBRO Prop Balancer \$2.50, Nylon Hinges (6) \$.95, (15) \$2.10, Kwik Glow Cord Set \$1.70, Ball Wrench Set \$3.35, Steerable Nose Gear complete \$2.50, Servo Mounting Hardware \$1.00; GOLDBERG Retracts (3) \$14.75, (2) \$7.95, Klett Hinges (7) \$.95, (15) \$1.70, Safety Driver \$.90; KO MUFFLERS .19-.30 \$10.25, .35-.61 \$12.25; UNIVERSAL Scale Wheels 3" \$3.80, 3 1/4" \$3.95, 3 1/2" \$4.10; DEVCON 5 Minute Epoxy Small \$.90, Large \$1.60; FOX RC Long or Short Glow Plugs \$.90 each, 12 for \$8.50; A-JUSTO-JIG Full House \$37.35

DIGITAL PROPORTIONAL RADIOS: KRAFT 5 Channel KP-5 \$240.00, KP-25 \$103.00, KP-4B \$333.00; MRC F724 \$225.00, F710 \$235.00, F713 \$125.00, Crystals (pair) \$9.00; MICRO CRAFT G45 4 Channel \$199.95

RC HELICOPTERS: DUBRO Whirlybird 505 \$87.50, w/K&B .40 \$105.00; HEG! Bell Huey Cobra \$280.00; KALT Bell Huey Cobra 450 complete with ENYA .45 engine and all accessories \$300.00 (We highly recommend this one. See October Model Airplane News P-74 for full details.)

COD PHONE ORDERS

Can't wait for our sudden service by mail? Then try our super sudden same day COD shipment service. Call 217-356-4294 until 9:00 P.M. Call Today - Build Tomorrow!!

ALL NEW CATALOG

Over 60 manufacturers at the lowest prices anywhere! All yours in our completely new Fall discount catalog. Send 25c in coin or stamps for your catalog, or receive yours free with any size order. Do it TODAY!!

HOW TO ORDER

Add \$1.00 to each order for full insurance, postage and handling. Alaska, Hawaii, Canada, and Foreign orders, add \$2.50. Check or money order only. Current catalog included with every order. SATISFACTION ALWAYS GUARANTEED

SUPER MONOKOTE

6 FOOT ROLLS

OPAQUES: Red, White, Orange, Yellow, Clear, Aluminum, Gray, Blue, Dark Blue, Black, Chrome, Olive Drab \$5.00

TRANSPARENTS: Yellow, Orange, Red \$5.60

METALLICS: Plumb crazy, Green, Blue \$6.50

SOLARFILM

6 FOOT ROLLS

OPAQUES: Dark Red, Bright Red, Dark Blue, Light Blue, Orange, Yellow, White, Black, Silver \$4.50

TRANSPARENTS: Yellow, Orange, Blue, Red \$5.00

METALLICS: Green, Gold \$6.00

FOR THE FINEST
IN R/C FITTINGS
USED THRUOUT
THE WORLD
LOOK TO
DU-BRO



MUFF-LAIRE[®]

NEW
FOR '73

Patent Pending
MADE IN U.S.A.

Sound
Reduction Engineering

Model MW-750 for .60 Webra

UNIVERSALLY ADAPTABLE!

Model MU-795 includes perforated steel clamping strap with worm-drive screw and fits a wide variety of engines. Also has hidden "no drift" positioning plates to hold muffler firmly in alignment on engine.

Patent Pending



MU-795
Shown mounted
on H.P. 60 engine.



MW-750

Varying the number of plates takes only minutes and controls noise level and back pressure to your desire. The ugly monstrous old fashioned muffler is now past history. Result—a much neater looking plane. Model MW-750 for .60 Webra engines fits on with only two furnished bolts.

PRICE **\$7.95**



NC-39
2 FOR
39¢

PRICE **\$7.50**
MW-750

**DU-BRO
NYLON KWIK-LINK**

THESE "SURE-LOCK" CLEVISSES ARE THE SAME SIZE AS OUR STEEL "THREADED CLEVIS." DU-BRO NYLON KWIK-LINKS ARE MADE FOR SELF THREADING ONTO DU-BRO RODS AND "THREADED COUPLERS" OR ANY OTHER RODS HAVING 256 THREADING.

NL-12 12" ROD WITH NYLON CLEVIS. 29¢

**DU-BRO KWIK GLOW
KG-200 GLO-PLUG CONNECTOR**

THE IDEAL GLOW PLUG R/C ENGINE CORD SET. SLIM 1 1/4" BY 1/4" ONE PIECE BRASS BARREL SNAPS ON TO PLUG. NO FLIMSY SPRINGS OR CONNECTIONS. WIRES FIRMLY ANCHORED IN TOUGH NYLON—CAN'T JERK OUT. EXCELLENT ACCESSORY FOR TODAY'S KIND OF R/C MODELER ENGINES. .10 AND UP. APPROX. 2 1/4" LONG.

KG-200 WITH ATTACHED BATTERY LUGS \$2.00



**DU-BRO
WHEELS**
featuring the
6 Spoke
Dura-Hub

NH-1	WHEELS 2 1/4"	2.59/pr
NH-2	WHEELS 2 1/2"	2.79/pr
NH-3	WHEELS 2 3/4"	2.99/pr
NH-4	WHEELS 3"	3.19/pr
NH-5	WHEELS 3 1/4"	3.39/pr
NH-6	WHEELS 3 1/2"	3.59/pr

Newly styled, hand inspected,
top quality tires with treads

REGULAR

TREAD
OR
Du-Bro smooth surface tires
available!

175R	WHEELS 1 3/4"	2.19/pr
200R	WHEELS 2"	2.39/pr
225R	WHEELS 2 1/4"	2.59/pr
250R	WHEELS 2 1/2"	2.79/pr
275R	WHEELS 2 3/4"	2.99/pr
300R	WHEELS 3"	3.19/pr
325R	WHEELS 3 1/4"	3.39/pr
350R	WHEELS 3 1/2"	3.59/pr

"T" OR "R"
**LOW
BOUNCE**

Low Bounce "SLICKS"

225S	WHEELS 2 1/4"	2.59/pr
250S	WHEELS 2 1/2"	2.79/pr
275S	WHEELS 2 3/4"	2.99/pr
300S	WHEELS 3"	3.19/pr



MADE IN U.S.A.

COMPLETE LEXAN BRAKE AND LINKAGE HOOK UP AVAILABLE FOR ALL DU-BRO WHEELS

DU-BRO BRAKE

Requires very little pressure to engage brake... is not affected by fuels.



Complete Brake & Linkage Hook-up
(11 PIECES)
CAT. NO. WB 100
\$2.95
EACH
WHEEL NOT INC.

SEE YOUR
HOBBY DEALER

DU-BRO PB-295 PROP BALANCER

DU-BRO PRODUCTS INCORPORATED
480 BONNER ROAD, WAUCONDA, ILL. U.S.A.
60084

PB-295 ONLY \$2.95

ROUGH PROPS RUIN PLANES AND RADIOS
ELIMINATE THE PROBLEM WITH THIS FINE TOOL
MADE FOR LONG LASTING SERVICE
ANODIZED GOLD COLOR CASE; ALUMINUM SILVER CAPS

LIGHTWEIGHT
CONTAINER CASE



KNURLED
PROP HUB
CONE PIECE

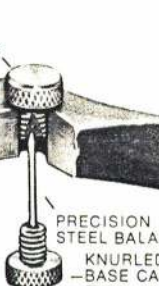

PRECISION GROUND
STEEL BALANCE PIN
KNURLED
—BASE CAP



FITS ALL PROP SIZES
BORED FOR 1/4" SHAFTS

A PROPELLER BALANCER YOU CAN CARRY IN YOUR POCKET!!!

THREE PIECES OF CAREFULLY MACHINED AIRCRAFT ALUMINUM PARTS CONTAINED WITHIN A SMALL CYLINDER 3/16" X 2 1/8" . . . SHOWS BALANCE ON LONG AND SIDE AXIS . . . EXCLUSIVE FEATURES

MAIL ORDERS F.O.B. FACTORY

PRICES AND SPECIFICATIONS SUBJECT TO CHANGE WITHOUT NOTICE

A Magnificent Flying Machine for .60 engines

Lancer

SL-62

\$39.95



KIT FS-30 SPAN 62" LENGTH 50" AREA 700 SQ. IN. FLYING WGT. 6¼ LB. ENGINE .60

A Contest-Caliber Sport Flyer

The Magnificent SL-62 is the result of 2 years' design and testing to meet the "if they had only made it this way" suggestions directly from the R/C Flyers in the Field. The result is this 62" Span beauty which has fulfilled expectations and aroused great enthusiasm with the R/C Flyers who have seen and flown the test models. Collective engineering-design is reflected in the fast and easy way the SL-62 goes together, and the flying . . . well, you've just got to take the Stick to believe it; it's that good.

Finest Quality materials include Prime Grade, Density-Selected Balsa sanded to micrometer tolerance. Imported Birch Plywood, etc. Fuselage features Die-Cut one-piece full-length sides, Plywood doublers (that go past wing for maximum strength), five Bulkheads—accurately Die-cut; combined with shaped Nose and Cowl blocks, quickly

go together to make a sleek strong fuselage; Topped off by a jet-shaped Canopy. Rugged custom made Aluminum Engine Mounts make engine installation a pleasure and formed music wire Tricycle gear includes fully-sprung stress relieved Nose gear.

Unique table-top construction insures a warp-free wing, a must for top performance. Wing parts are Die-cut, shaped, etc., to insure fast accurate assembly; and Balsa Sheet covering keeps warps out, resulting in a light rugged wing. Tapered strip Ailerons provided, are simple to install using the new ready-to-use simplified Aileron linkage units. Wing assembles to fuselage with nylon screws in hardwood nut-block provided, in the unusually complete Hardware pack which includes all the special nylon R/C fittings required. Rudder and fin are sheet, Stab is built up and sheet covered to keep it permanently flat.

STERLING MODELS • BELFIELD AVE. and WISTER ST. • PHILA., PA. 19144

If no dealer available, direct orders accepted—with 10% additional charge for handling and shipping. (60c minimum in U.S., \$1.25 minimum outside U.S.)

- Catalog of entire line of airplane control line model kits, R/C scale and Trainer kits, boat model kits, accessories; etc. 25c enclosed.
- "Secrets of Model Airplane Building." Including design, construction, covering, finishing, flying, adjusting, control systems, etc. 25c enclosed.
- "Secrets of Control Line and Carrier Flying." Including preflight, soloing, stunting, Carrier rules and regulations, Carrier flying hints and control line installation instructions. 25c enclosed. No checks. Only U.S. money orders or currency accepted.

Name _____

Address _____ City _____ State _____ Zip _____



Take a Good Look at These.....

Fabulously-Authentic Super-Detailed

"Stick Model" Kits

THEY'RE FAMOUS

Piper Cub Super Cruiser is a classic 3-passenger light plane of the forties, and an old time modeler's favorite.

- Citabria made by Bellanca — a real aviation pioneer, is the sleek, powerful, modern light plane, a familiar sight at many airports
- Curtis P-40 Warhawk. Work horse of World War II, made immortal by the Flying Tigers in China and Burma.

THEY'RE UNIQUE

Because such amazing detail scale authenticity is achieved with kits that are relatively easy to build. Plans include 3 views of full size Aircraft and show how to install movable controls from cockpit. Authentic color scheme shows on full color kit box lid.

THEY'RE VERSATILE

Kits can be built 6 different ways: Rubber powered, as supplied, then using 020, 049 or CO₂ for power: Free Flight, Control Line, R/C (with pulse or single channel) for static scale. Any way makes a museum-like model.

THEY'RE EASY TO BUILD

Just about every frame member is accurately Die-cut from the finest quality Balsa Wood, sanded to micrometer tolerances . . . and every part is numbered to insure fast and accurate assembly as shown on easy step-by-step plans.

THEY'RE COMPLETE*

Highly detailed plastic parts included, simplify the assembly and add a genuine touch of realism-in-miniature. Covering material, pre-formed wire parts, wheels, authentic decals, hardware pack that includes control system parts; is a partial list of the contents of these fine quality kits.

* Dry Kit. Rubber power material supplied.
Other power and equipment not included.

THEY'RE AT YOUR DEALER

GET OVER AND SEE THEM NOW . . . BUY ALL THREE



SPAN 35½"
SCALE 1"=1'.0"

**KIT E-6 PIPER CUB
SUPER CRUISER 7.95**
12 Pack — 15 lbs.



SPAN 33½"
SCALE 1"=1'.0"

KIT E-5 CITABRIA 7.95
12 Pack — 15 lbs.



SPAN 27"
SCALE ¾"=1'.0"

KIT E-4 P-40 WARHAWK 7.95
12 Pack — 16 lbs.

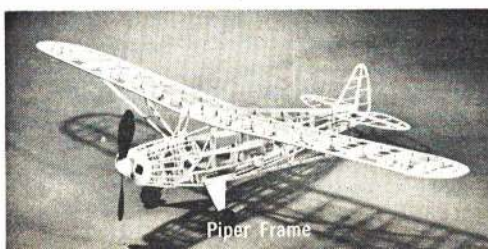

Piper Frame



Citabria Frame

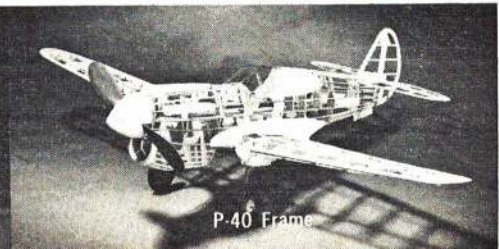

P-40 Frame



720 TURN

Many years ago when I was learning to fly in a J-3 Cub, my instructor had me practicing 720 degree turns by the hour. The maneuver was judged to be good if we hit our own slipstream the second time around indicating that altitude had been held constant. I've never forgotten those 720 turns, but it is coincidental that this ship happened to turn out with 720 sq. in. of wing area and is trimmed for a two turn or 720 degree power pattern. There is, however, no danger of encountering its own slipstream on the second turn as there will be a considerable difference in altitude at that point in the flight.

I'm certainly not going to claim this ship is the ultimate in competition power models. If I thought that the ultimate design were possible I would quit today. For me, Free Flight is truly the greatest of all model flying, unlimited in challenge, development, and best of all, pure enjoyment. May it live forever!

Simple, warp-resistant structures
give competition performance
reliability.

Excellent text on trimming too.

CLARENCE HAUGHT

The 720 turn happens to be my best design effort at this time. I have incorporated the features I believe to be the most compatible for a compromise situation—that of a fast, high climb and a floating glide. Either of the above-mentioned characteristics are easily attained but when efforts are made to combine them it is a compromise at best.

For the climb portion of the flight to gain that all-precious altitude for a better chance at the elusive thermal, I

have relied upon a thin, flat bottom airfoil. It's sort of a "draw around your shoe sole" airfoil of questionable ancestry but it works on this design. It was kept under 10% in thickness in hopes of reducing drag without sacrificing lift. Another drag reduction measure is the use of minimal frontal area.

Keeping the structure as light as possible, yet with sufficient strength, contributes to overall climb and glide performance.

Probably one of the most important climb influencing factors is the power plant. The original ship utilizes an Enya 29 setup with the high compression head and the No. Three venturi insert running on a pressure fuel system with high nitro fuel. 9-4, 10-3½ and 10-4 props have been used with good results. (Start with the 10-4 and work back to the 9-4 as the ship is more docile on a 10-4.) A competitive free flight must have a "going" engine. The 720 turn

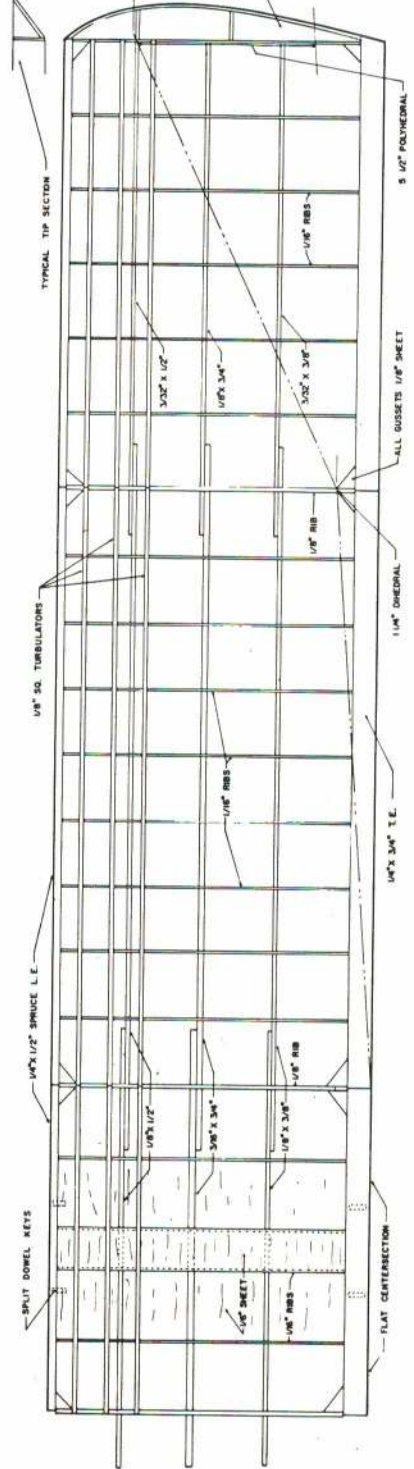
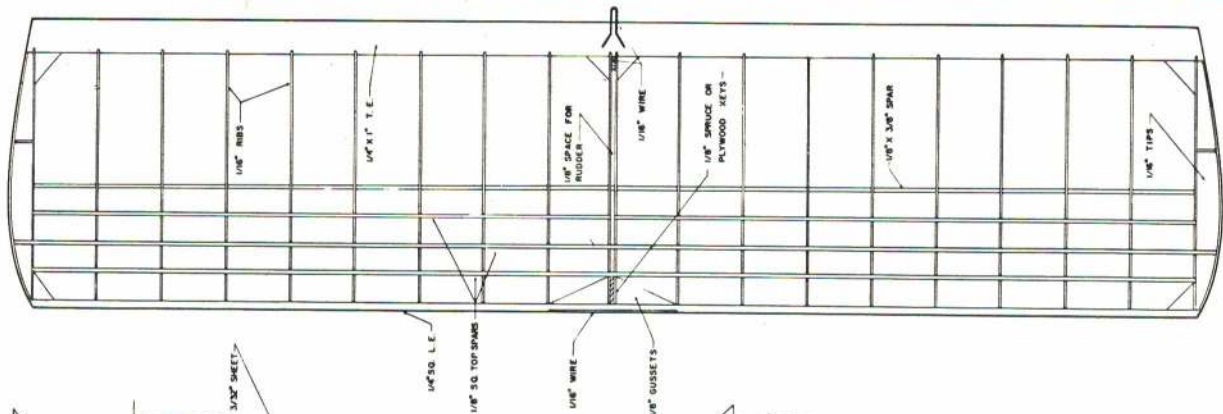

WASHOUT WING THIS 1/4\"/>

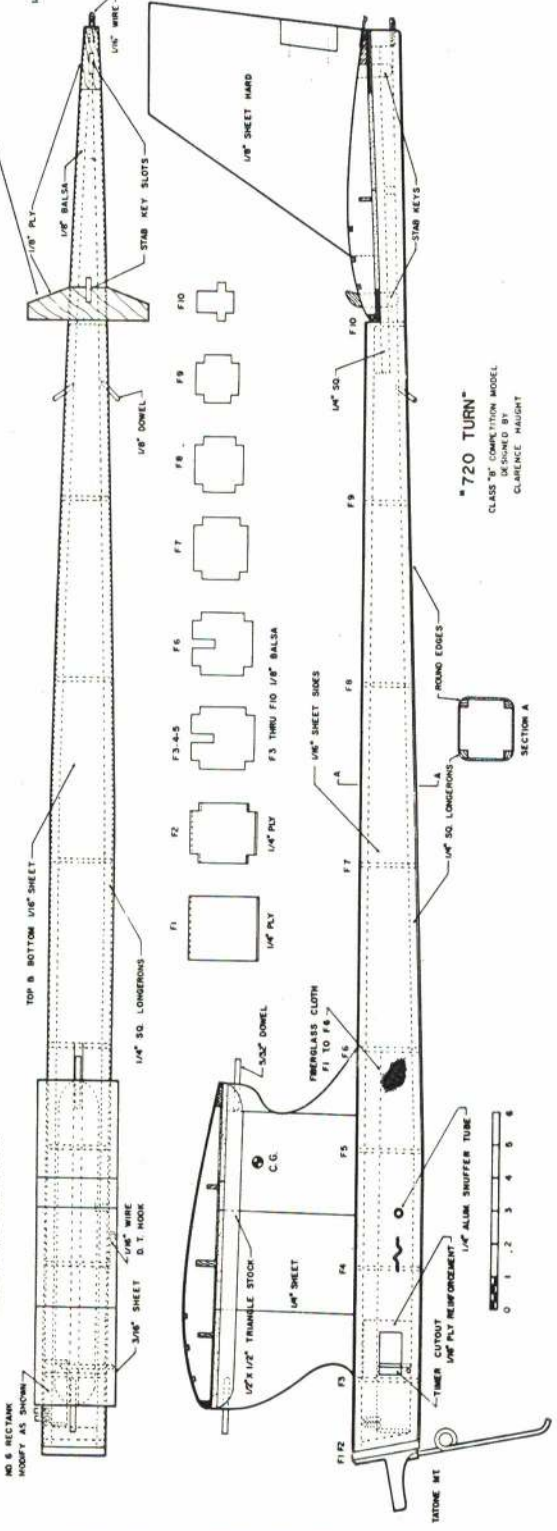
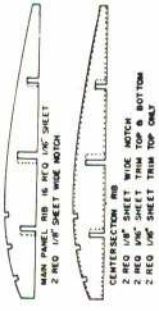
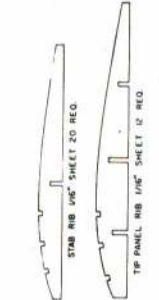

"720 TURN"
 CLASS "B" COMPETITION MODEL
 DESIGNED BY
 CLARENCE HAUGHT



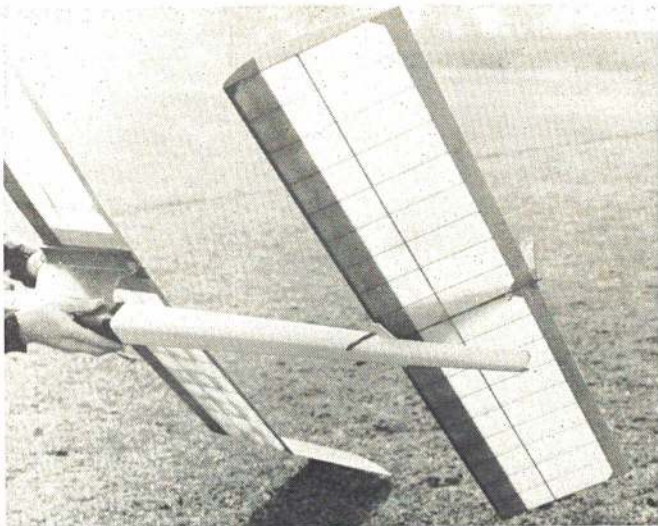

Forty degrees pop-up DT is ideal on this model. Fuse trips the DT and is located along the fuselage.

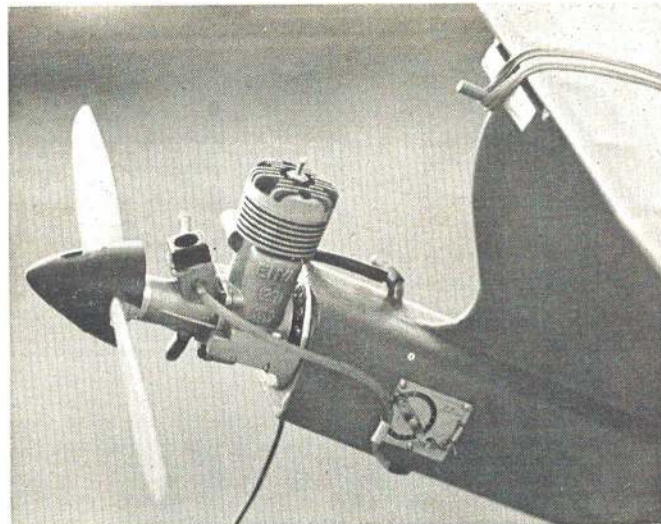

The motivating force is an unmodified but carefully freed up Enya. Flood-off use to stop engine run.

was intended for Class B competitions so I have not experimented with larger engines. However, the above combination provides a spectacular performance controllable without a Variable Incidence Tailplane. A larger engine would definitely require more downthrust as the increased climb speed with resultant increase in lift will create looping tendencies.

As mentioned before, I trim for two turns in the climb. It could be less but the advantage is a faultless, consistent transition which to me is a better buy than a few more feet of altitude and an occasional bad transition. The altitude difference just isn't that much.

In the glide department you can probably spot my Nordic upbringing. A high aspect ratio to ride those gentle currents with the lowest possible sink and turbulator spars to extend still-air time, while providing valuable structural strength with low weight penalty. You'll note the reference to "still-air" and "gentle currents." Any old barn door will turn in a max in a good thermal so why not put in a few still-air performance features? If your ship has these capabilities, a quick on-site trim change, born of familiarity and experience with your ship, and you're ready for smooth or rough air.

The pylon layout was chosen for this design over the high thrust layout. Here again, a compromise must be reached. High thrust ships are less sensitive to trim changes and are much easier to handle in this respect, but that engine, nacelle and prop combination sure creates drag and turbulence at a poor place—right in front of the center wing section. This will have a negative effect on the lift generated by this portion of the wing. A pylon mounted wing can operate in undisturbed air for the most part. The slightly more difficult trim characteristics are easily worth the better glide.

All these things add to the model's potential to do well in a meet. Of course in free flight a well designed and trimmed model is only part of the game. Launching into good air and just plain luck have an important bearing on suc-

cess as well. The fact that the same guy doesn't win *all* the time is another reason why free flight is so great. Of course the more effort exerted, the more often Lady Luck will smile in your direction.

Reliability of your equipment is vitally important, too. How many times have you seen some hot dog sit on the ground all day with a hybrid machine with so many bugs in it no official flights are made and the meet is won with a simple, consistent, reliable model? Practice and know the flight characteristics and traits of your model thoroughly before entering competition. Use proven, reliable systems. I suggest the use of a pressure fuel system with a tin tank and a "squeeze off" timer. This works best for me. Pacifier tanks, flood off systems, etc. are all good; if they work for you, use them. All I'm saying is use a good system that works for you consistently and keep good fuel tubing installed. Make frequent checks of all fittings, screws, fasteners, etc. and strain all fuel through a filter on your fuel can or in the actual aircraft system. It will show up on your trophy shelf!

Flying a new ship is always a "nervous" experience but can be lessened somewhat by a careful systematic approach to the subject.

Set the ship up with CG and downthrust as shown on the plan and slight left or zero sidethrust. Wash-in the right main wing panel 3/8 in. (TE down) at the dihedral break and wash-out both tip panels 1/8 in. (TE up) at extreme tips. The left main panel should be flat. The wash-out at the tips is to prevent the tips from stalling before the main panels resulting in spins or spiral dives. The wash-in in the right main panel serves to hold the right wing up during the right turn power pattern. This warp will also help prevent the model from spiral diving in during the right turn glide when strong lift is encountered.

Tilt the stabilizer right tip high so that it is approximately parallel to the right main wing panel. This will produce the desired right turn glide.

From this point all trim adjustments should be one of the appropriate four listed below.

Glide turn—more or less stab tilt as required.

Climb angle—shim up trailing edge of stabilizer to increase climb.

Lower stabilizer trailing edge to reduce climb angle.

Power turn—use rudder tab, usually none or slight amount required to produce two full turns on full length motor run.

Glide angle—shift center of gravity, add nose weight to avoid stall, add tail weight to slow glide.

The above trim adjustments act independently with the possible exception that stab tilt will affect stab incidence slightly. Using this system, a change in one adjustment can be made relatively independent of others. When trimming any ship, make only one change at a time and proceed slowly.

We are now ready for the moment of truth. Select the calmest possible conditions hopefully in an area covered with the proverbial tall grass. Check alignment once more and hand glide to determine if a stall or dive tendency is present. Shim trailing edge of stabilizer accordingly. Hand glides on a ship this size prove little and expose the ship to unnecessary damage.

Always use the dethermalizer on all flights. Thirty seconds is good for tests as it reduces chase time and allows more power flights. Also if a poor adjustment is evident there is less chance of damage. I prefer the remote DT fuse location rather than the usual tail mount as a ship this size is too awkward to handle alone if the fuse is on the tail.

A three sec. run at 75% power will tell you if any vicious turning tendencies are present. Follow this with a three sec. full power run. If all is well, proceed with two sec. extension in the engine run and work up to a full length run. Add rudder tab as necessary to achieve a two turn power pattern. Climb angle should be about 75 degrees. As the power run is increased, speed will increase and may produce a steeper climb. Don't worry about transition until you reach nine sec. power runs. If it is not up to your expectations, you

(Continued on page 70)

NEW! FASCINATING!



Collector's Series

Authentically Detailed Plastic Kits
of the Most Famous World War I and 'tween Wars
Fighter and Bomber Planes

These exciting kits in 1/48 scale truly portray the cockpit design, type of engine, the armament, and the mechanical equipment of these vintage planes that gave birth to aviation history. The kits come complete with national identification decals, battle terrain base, and full rigging and painting instructions. Each is beautifully packaged with full color action illustration on the cover of box. We call it The Collector's Series because once you've built the first one you'll want them all.



1108 NIEUPORT 28C.1



1109 PFALZ D III



1115 BOEING P-26A



1125 DE HAVILAND DH-10A

The complete "Collector's Series" includes:

- | | |
|-------------------------|-------------------------|
| 1100 SOPWITH TRIPLANE | 1126 GOTHA G.V. |
| 1108 NIEUPORT 28C. I | 1134 FOKKER E III |
| 1109 PFALZ D III | 1135 FOKKER E.V |
| 1115 BOEING P-26A | 1136 HALBERSTADT CL. II |
| 1122 BOEING F4B-4 | 1141 BREGUET 14 |
| 1125 DE HAVILAND DH-10A | 1142 ALBATROSS C. III |

Enclosed is 25¢ for beautifully illustrated full color catalog of complete line.

Name _____

Address _____

City _____ State _____ Zip _____ AAM



K&B MANUFACTURING

DIVISION OF AURORA PRODUCTS CORP.

12152 WOODRUFF AVE. DOWNEY, CALIFORNIA 90241

Graupner

*the brandname
for top quality!*

R/C SAILPLANE MODELS

DANDY

Ind. No. 4227

Wingspan 63"
ideal model for intro-
duction, convertible
to powered glider

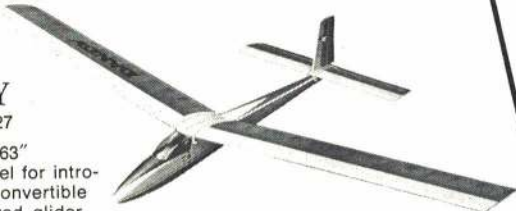

AMIGO II

Ind. No. 4219

Wingspan 78³/₄"
for simple aerobatics,
convertible to powered
glider

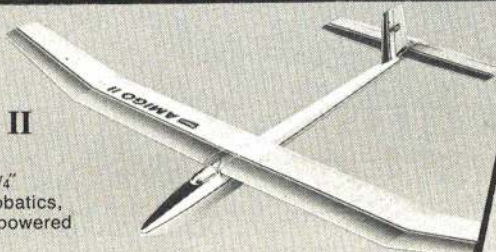

CUMULUS 2800

Ind. No. 4235

Wingspan 110¹/₄"
A-R-F-soarer with swept
surfaces, convertible
to powered glider

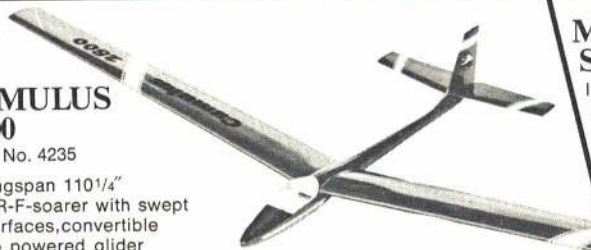

CIRRUS

Ind. No. 4229

Wingspan 118¹/₈"
successful as the
original, ready-
formed fuselage components,
convertible to powered glider

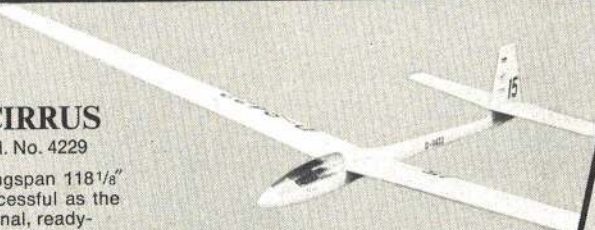

AS K 14

Ind. No. 4237

Wingspan 90¹/₂"
ready-formed,
powered glider for aerobatics,
for engines of up to .15 cu. in.



R/C POWER MODELS

TERRY

Ind. No. 4635

Wingspan 41³/₈"
handy introduction
model, for engines
of .09 cu. in.



TAXI

Ind. No. 4625

Wingspan 59¹/₁₆"
R/C trainer for engines
of .15-.35 cu. in.



MIDDLE STICK

Ind. No. 4631

Wingspan 55¹/₈"
aerobatic model
designed by former
World-Champion
Phil Kraft, U.S.A.
for engines of
.40 cu. in. and the NSU/Wankel model airplane engine

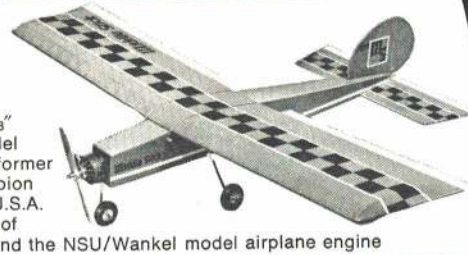

KWIK FLY MK 3

Ind. No. 4629

Wingspan 59¹/₂"
low wing designed
by former World-
Champion Phil Kraft, U.S.A.
for engines of .60 cu. in.



CESSNA 177 cardinal

Ind. No. 4633

Wingspan 61"
for engines of
appr. .30 cu. in.
semi-scale after
the new CESSNA type, ready-formed components



AHM, Associated Hobby Mfrs.,
Inc.
621 East Cayuga Street
Philadelphia / PA 19120

French Motor Co. Inc.
33, Berry Street
San Francisco / Calif. 94107

Midwest Model Supply Co.
6929 West 59th Street
Chicago / Illinois 60638

Royal Products Corp.
6190 E. Evans Avenue
Denver / Colorado 80222



PLANE ON THE COVER

The word "intention," according to Webster's "often applies to little more than having an idea in mind, or the will to act or do a certain thing." With this in mind, it would seem that most modelers are inherently blessed with all manner of "good intentions/ideas." In most cases, the only catalyst required to convert these intentions into reality, is simply ample free time applied towards the varied types and numbers of model subjects in mind for the future.

More often than not, we do complete some of our model-intentions. Some require the passing of more time than others before completion. Then there are those which are just passed over due to the advancements in the State-of-Art, or forgotten over the years. I have dropped a few intentions along the way, as most of us have. On the other hand, I have managed to complete some which date back a few years. Recently, for example, I completed an intention of twelve years—that of restoring a full-size aircraft. Today I am the very proud owner of a classic 1947 Stinson-Voyager, N-12-DB (Best Stinson Classic, 1971 EAA Convention). The original intention was easy to come by; the time for actual restoration was "sumpin' else." The model presented here, though a new design, is really the completion of another intention that dates back to 1969.

Ostensibly, Viper began as only an intention while completing the research covering the North American P-51 Mus-

The 1972 Toledo design and finish winner is a state-of-the-art pattern ship. Fast, predictable, and smooth even in gusty winds. It is a model for the expert builder and flier.

DARIO BRISIGHELLA, SR.

tang for an ultra-scale model (another good intention). As so often one project is shelved in lieu of another, so went the Mustang. My scale deHavilland Hornet took its place, as did the Stinson restoration project. The Mustang remains shelved, but that intention is the prime contributor and factor of this design.

Obtaining the airfoils and sections employed on the Mustang was a feat in itself. Once accomplished though, these laminar flow designs really "turned me on." I became intrigued by the rather unusual curves and reflexes of these high-speed sections. Thus Viper-intention began. Someday I would experiment with these sections on a non-scale design, or at least before completing the Mustang.

There were many long discussions about this project with other modelers. Seldom, if ever, were there any encouragements. Many had doubts and fears. The laminar-flow sections almost became more challenge than intention.

Certainly obvious was the fact that a non-scale design would provide the best test vehicle in the least amount of time. My next pattern design would begin around these airfoil sections.

Undoubtedly, from the onset, there could be more gained than lost in the experimentations. If the sections proved to be "another bag of worms," the test model could always be fitted with another wing—a small price to pay should it someday save the early demise of the "still intended Mustang." Needed then was only the free time to begin. Sound familiar?

Inadvertently, as accidents occur, three fractured fingers left me with all sorts of time late in 1971. This period was not what I'd consider "good time," but I was grounded and idled. So I began the roughest of unnatural, left-handed sketches for Viper. Now there was time to incorporate new ideas and methods into those older ones learned through experience.

The only design parameters that can provide the exacting performance required of our pattern competition models are those found by the tried and proven methods. This will include many hours of testing, modifying and testing again. Reynolds Numbers, lift-drag ratios/coefficients, scale effect, etc., have little effect on RC as we know it today. Designs based upon these terms generally turn out poorly.

About the same results can be expected of the "Averager Design," a

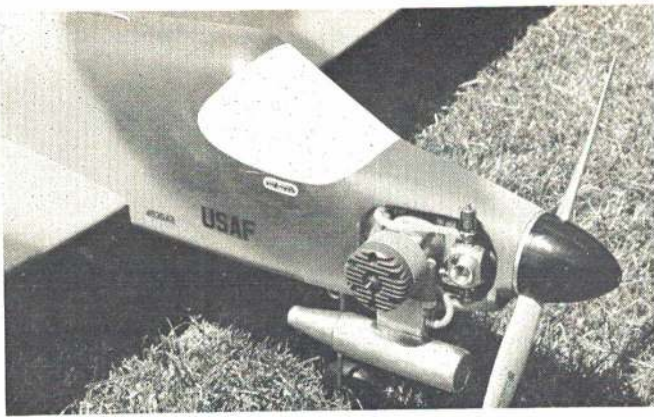

Neat and uncomplicated engine installation. Webra rests on Kraft-Hayes plastic mount.

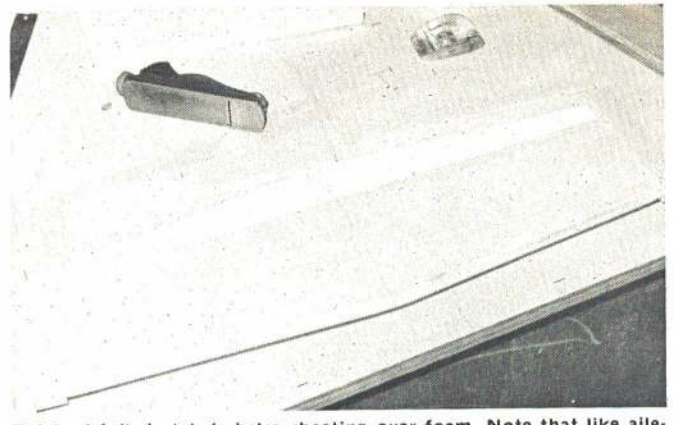

Thick airfoiled stab is balsa sheeting over foam. Note that like ailerons, elevators are foam cored. This guarantees airfoil continuity.

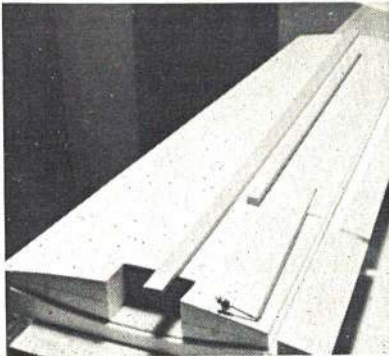

Sheeted wing is ready for aileron and wing facing, then hinging. This unusual airfoil required precision work.

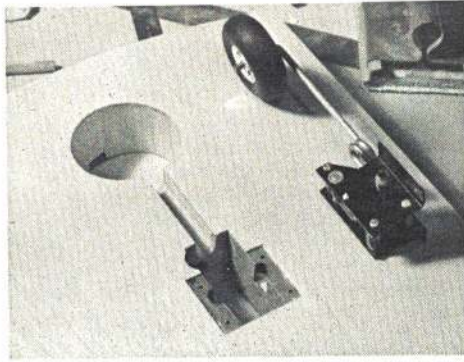

Pro-Line retract system is flown in one plane and shown being installed here. Violett landing gears are also considered excellent.

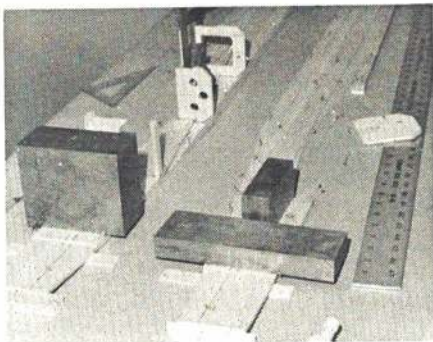

Rather than bend fuselage sides to fit bulkheads under tension, sides are water and ammonia soaked and laminated for doublers and bent on this jig. When dry, bend stays in without tension.

Very important to accurate modeling is use of centerlines throughout. Text describes in detail.

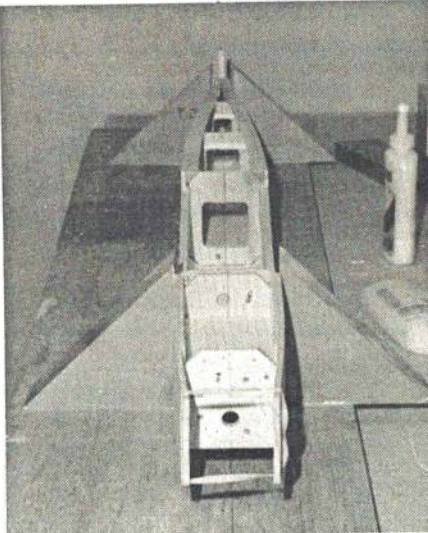
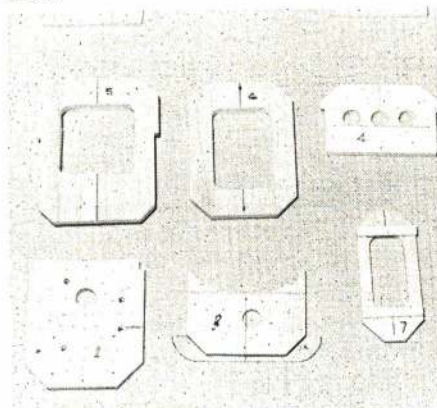

This shows proper lineup of the centerlines and accurate fuselage side alignment with heavy triangles.

phrase coined recently by one well-known RC editor, in which the averages compiled from some sixty-odd good models are used in achieving the ultimate in design. However, when employing average design methods, one should expect an average, not ultimate, model. Averages can only lead to averages! Those items or combinations of items which perform well for one model seldom, if ever, perform well in combination with another set of conditions. I am not proposing that all designs begin on a "hit-or-miss" basis. In the Viper, other than the laminar-flow sections, combinations known and learned through experience were the only guidelines. Inspired by the new wing sections, it led to some newer approaches toward the over-all design. The six available weeks helped, too. The completion of the drawings and the arrival of New Years Eve, 1972 were simultaneous.

The Toledo Conference was but 56 days off as the first balsa sheets were cut. Things went along smoothly even though some of the construction techniques were slightly unorthodox (foam ailerons), in an effort to maintain alignment and retention of the laminar sections. This "Toledo-bound" model was first presented, unpainted, at the January meeting of the Milwaukee Flying Electrons, nine days after its start. It was not alone—another member also displayed Viper Number Two the same night. The old doubts and fears were more in evidence that night than the models themselves.

Of the remaining 47 days before Toledo, 37 passed during the final assembly and finishing. Five more days passed for the display stand, leaving four days for some needed arm resting before the long drive to Toledo. Friday night in the Rec-Hall Viper made its formal debut, as yet, unflown!

The model stirred more than just casual interest. I noticed the apprehensive faces of the onlookers, who were aware of its distinctive airfoils, knowing it still was earthbound. My spouse, who was in charge of babysitting my models, began to have her own doubts of the venture, after overhearing the comments of the viewers.

Toledo is where it's at! To even "place" there is more than ample reward for one's efforts when viewing the quality of craftsmanship on display. If

you've not tried it, let me tell you there are some very tough acts to follow! The awards I received there for Viper were far above my wildest expectations! I again extend my all too simple "Thank You" to all the Weak Signal members.

Mother Nature saw fit to prevent any test-flying of Viper No. Two until April Fool's Day. All of us in attendance braved the cold winds, slogged through the still remaining snow, standing water puddles and sticky mud. It may have been springtime around the country, but here in Wisconsin one would never have known it. A single but brief flight ended the doubts and fears concerning the laminar flow sections!

The model displayed some amazing speeds as it cut through the choppy cold winds, rock-steady! (Something not expected due to the rather sharp leading edges.) The next question was just how fast must this thing be flown in order to bring it down in one piece? The new Black-Head decided to quit when the question cleared my mind; the position the model was in at the time could never have been more dangerous. To make the open part of the field would require a very tight turn as the model's altitude was less than 20 ft. Even the tight turn and stretched-out glide required for the landing proved to be no problem whatsoever, as Viper settled at a snail's pace. Only one flight, and everything learned added up to the black side of the ledger! Speedy, rock-stable, good penetration, ample response in the ailerons with no indication of any tip stalling tendencies at ultra-slow speeds—some display for one flight! As we left the field, the doubts left too.

Considerable testing continued throughout the following weeks; the weather improved slightly. With most any new design not all its characteristics are going to be on the plus side. Viper's only undesirable trait proved to be a slight rolling tendency when yaw control (rudder) was applied. The balance of its performance left little, or nothing, to be desired in pattern maneuvers. Modifications were made on the field to the fin-rudder combination, with little effect. There were of course many comments as to the cause—most cited the airfoil, naturally. (What else?)

I was convinced the cause lay elsewhere, and was willing to modify or try anything, but not the wing sections! The wing, I felt, offered the superior performance in pattern work—too much to give up! In further evaluation flights I concluded the problem lay in the wing dihedral angle. Another model was near completion at this time, and was modified with less angle. In a week testing began again with Viper No. Three and the problem ended. No. Two was then modified and confirmed the results, even though it still wore the modified fin/rudder combination. These models were soon joined by Viper No. Four built by yet another flier. The original Viper No. One (shown at Toledo) awaits this modification before it leaves the ground—another intention?

Lots of flying and competition have done much to really prove the design.

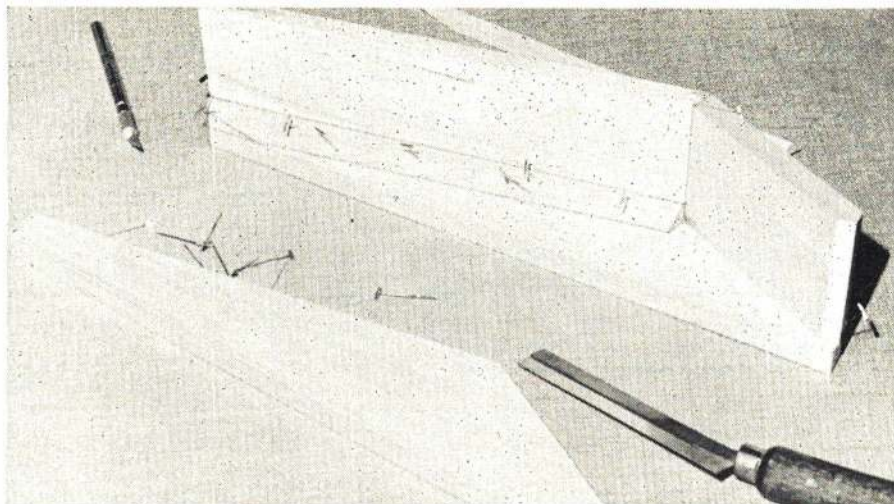

Above: What looks like a canopy is built up of balsa blocks and triangles. Space inside will house battery packs.

Right: Before carving and sanding, fuselages sure look ugly!

Below right: A Viper takes on smooth curves. Fit the engine to aid in shaping the nose.

Below: Vipers 1 and 3 differ in that the latter model has less dihedral. Several have been made by very different builders; all perform the same.

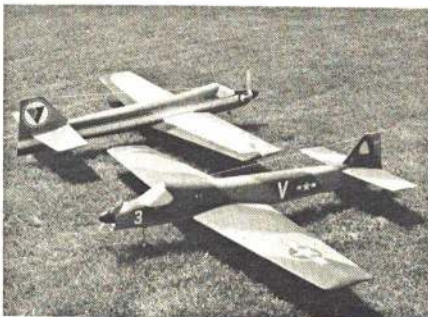
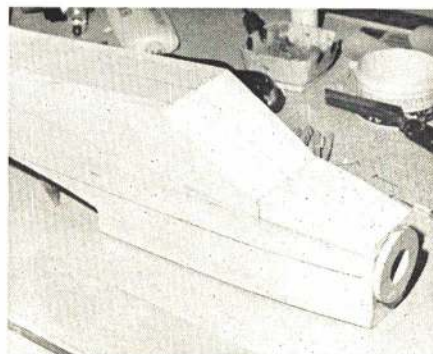

Author with Toledo winnings. Dario still has not flown the original plane—it is too pretty! The others fly all the time when Dario is not making helicopters.



**FIRST PLACE WINNER:
1972 TOLEDO CONFERENCE
Best Original Design Award and
Most Outstanding Finish Award**

CANOPY NOTES
FRONT AND TOP SHEETS ARE
2.08" WIDE ASSEMBLE ENTIRE
CANOPY UNIT BEFORE CEMENTING
TO BASIC FUSelage SPINE LINE
NOTE THE 1/2" TRIANGULAR STOCK
IN ALL INSIDE CORNERS

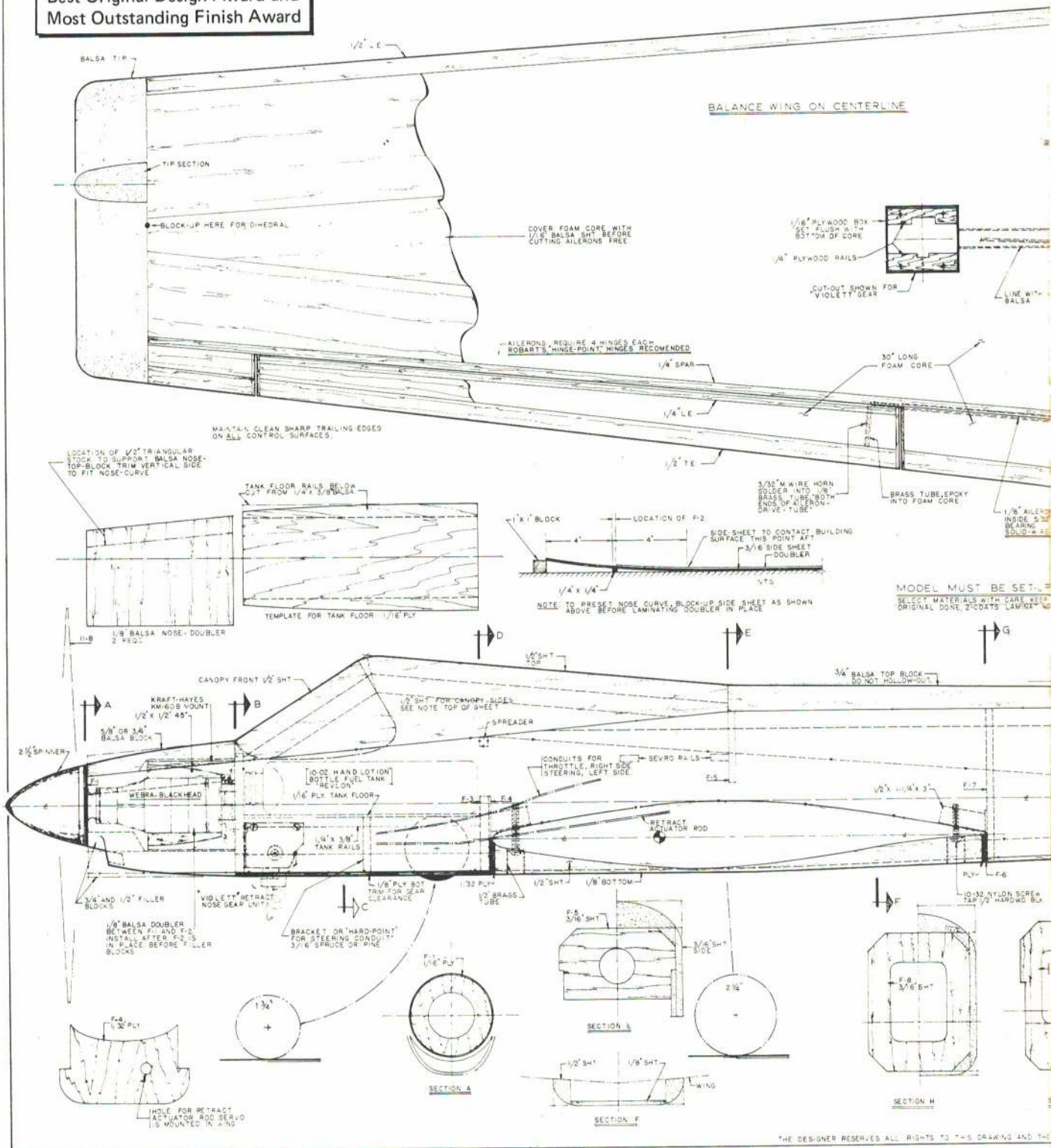

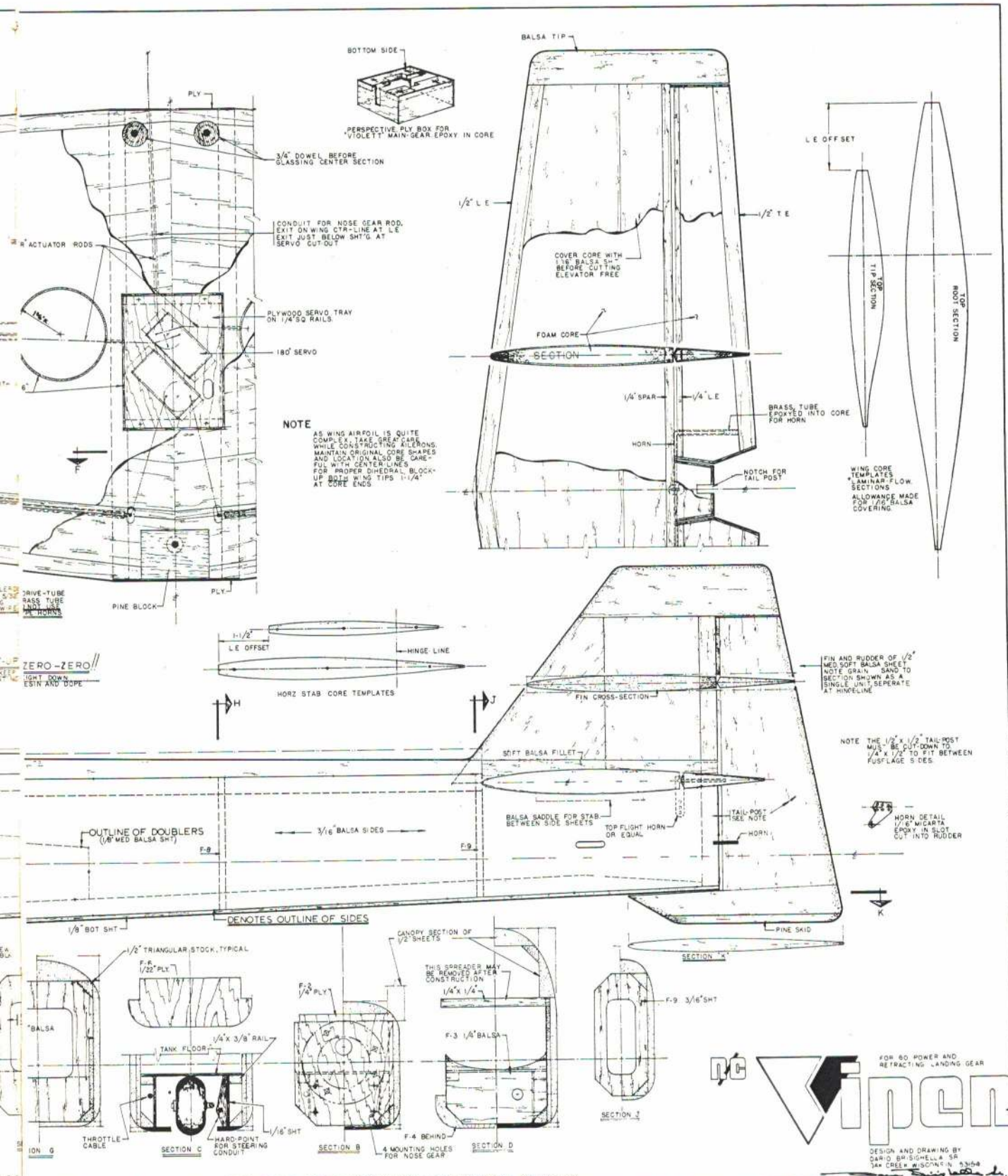

SIGN HEREON. NOT FOR DUPLICATION WITHOUT WRITTEN APPROVAL. POSSESSION DOES NOT CONSTITUTE THIS APPROVAL FEB-MAR 1973

FULL SIZE PLANS AVAILABLE - SEE PAGE 84

We who have flown the Viper are convinced that the laminar sections do make great difference over the more conventional sections. I claim no knowledge of exactly how these sections join in making Viper the speed demon it is and yet give it the super-stability it has in slow flight. Nor can I explain how it can be so docile and predictable in any maneuver, in most any wind conditions (It is well suited in choppy crosswinds.)

I have designed and flown a few models over the years, but I feel none can begin to compare with Viper's performance. It just must be experienced to be appreciated! The laminar flow wing design does make the difference. A word of caution, however, is in order. Viper requires a little extra space and time in which to burn off some of its speed, so give it a little room. Don't expect it to slow in an instant for those short-field landings.

Rather than bore you or challenge your abilities with pages of construction details, I'll only touch on the subject and pass on a few ideas I use which can be employed on any other model as well. When cutting out the various formers, doublers, fuselage sides, etc., try cutting the templates and, with Sanford's Rubber Cement, cementing directly to the required materials, thereby eliminating the chance of error found in transposition. You can save the original plans by tracing off the various templates onto tracing paper first and cementing these tracings onto the materials. Don't forget the all-important centerlines too!

While on the subject of centerlines, here's a little trick I use. While the paper template is cemented on the work piece, I drill a 1/16" hole through the piece, directly on the centerlines, this way when the template is removed I can locate and scribe the centerlines on both sides of the workpiece with accuracy. In the case of fuselage sides top blocks, etc., even after final shaping and sanding, the centerlines can always be located and rescribed for final alignment and reference. The small holes can be easily filled just before the final finish. Neat?

Performing the required curve of the fuselage sides is a simple task if done while cementing the doublers in place in the laminating process. (See the small sketch on the plans.) The sides are actually over-bent in this case at the start, but when the pressure is released, you'll find the finished curve is just right. The drawings do not show the top-view of the fuselage but this should offer no challenge to those who prefer to build over a drawing. Checking the various cross-sections, you'll find the actual fuselage sides are flat, parallel to each other, across the wing-saddle section to a point mid-way, the fuel tank area. Oh, yes. You'll have to buy the little woman a bottle of hand lotion if you want a fuel tank.

Build the canopy as a complete component, including the triangular stock reinforcements before cementing to the fuselage itself. Any model will fly only as true as it has been built, so watch those centerlines!



At rest on the gear, Viper has that look of ready action. Note the moveable sub-fin. This is most helpful in wingovers.

If you've looked at the drawings at all, you'll be aware that the ailerons and the elevators are actually part of the original foam cores. These make the job a lot easier than it looks. Simply sheet the cores, add and shape the leading and trailing edges, remove the narrow section indicated for the 1/4" spar, which in turn becomes one of the hinge edges. Remove another 1/4" for the other hinge edge of the control surfaces involved and the task is complete. Use the "female" section of the core blocks to retain alignment and don't forget the centerlines! You can save the messy job of cementing the wire horns later by inserting the small section of matching brass tubing into the control surfaces during construction. When assembling the wire horns, simply slip into place without the epoxy messing up your finish. I have made no attempt to shape the ailerons of balsawood, as the shapes involved are too complex. This is how the foam control surfaces came about. I find this method faster and more accurate than any other method, too. Keep the centerline hole idea in mind for the hinge line spars—they do help!

When the model is complete and all the equipment is in place, be sure to balance the model along both its longitudinal and lateral axis, don't forget the muffler if you use one. A few regular nails pushed into the left-hand wing panels will overcome the side-mounted engine. The CG as noted on the plans is only my preferred location, and can be used as a starting point for locating your own preference. The originals have been tested with the CG located up to one in. forward and one in. aft of the position shown with no ill effects, though it is more docile when placed as indicated.

If you are looking to me for that all-perfect, award-winning finish in three easy steps, forget it! There is just no easy way! How many others have written about sanding, sanding, and more sanding? To this I can only add: rubbing, rubbing and still even more rubbing! The Toledo model is finished in that "old standby," dope over two coats of laminating resin. This included approximately 50 sheets of assorted wet and dry sandpaper, ten coats of white dope as a base, ten coats of each color of the paint scheme, followed by still another ten coats of clear dope over "The Whole Thing." Between every coat of dope was a lot of wet sanding with 600 grit, then before applying the next coat, the surface was wiped dry with DuPont Prep-Sol to remove any particles of dust, fingerprints, etc.

(Continued on page 82)

We're worth traveling for!

NEW YORK

Paterson

Newark

Jersey City

Elizabeth

Flemington

Trenton

Camden

Atlantic City

PENNSYLVANIA

OUR NEWEST STORE (OAKHURST, N.J.)

OPENING FALL 1972 (TOMS RIVER, N.J.)

And you'll see why when you see our fabulous selection of leading hobby merchandise, all at low, low discount prices! We carry the top name brands in U/C and R/C equipment for your buying convenience. You'll be glad you traveled... when you see what's in store for you at our "one-stop" shopping centers for hobby merchandise. Centrally located for New York, New Jersey and Pennsylvania residents.

U.S. ROUTE 22, GREENBROOK, N.J. PHONE (201) 968-0440

U.S. ROUTE 35, MIDDLEBROOK SHOPPING CENTER, OAKHURST, N.J. PHONE (201) 493-2022

Both stores open daily 'til 9:30 - Sundays 10 to 5

TINY TOTS

PLAY & RECREATION ITEMS FOR EVERYONE

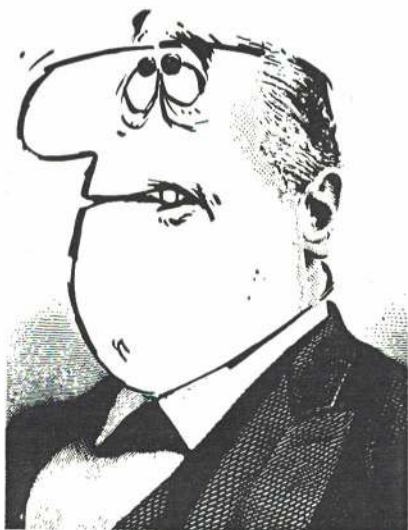

I used to cover all my models with silk ...

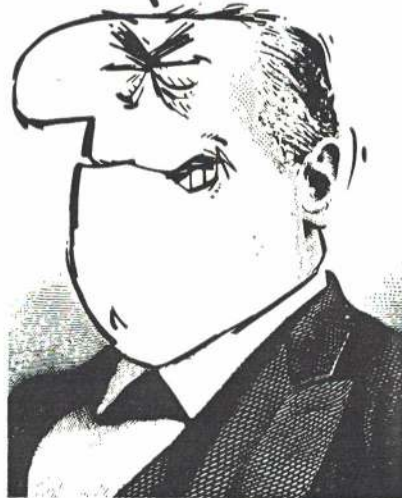

and I looked like this.



now I use Silk-Spun Coverite and I smile like a blithering idiot!!!

First of all, Silk-Spun Coverite goes on with an ordinary iron. That takes care of the usual gluey mess. Second, it finishes like glass with only 2 coats of paint. Third, it's tougher than any other covering except our own original Super Coverite. Fourth, it's light enuf for every type of aircraft. Fifth, Silk-Spun is now available in 4 translucent colors. Sixth, it's packaged in the biggest "twice-as-much-for-the-money" size you ever saw. Seventh, if you haven't tried Silk-Spun because you think it's gimmicky, you're dead wrong. Champions like Walt Moucha, Josh Titus, Ernie Weiss, Ed Ellis, John Roth, Bryce Peterson and Harold Vanderver have won major contests with Coverite covered planes!

Coverite
Jenkintown, Pa.





MO-BIPE

During the 1920s Martin made the MO-1 monoplane which was used as the subject for both a Class I and Class II Navy Carrier ship. The Class I version appeared in the August 1969 issue of *American Aircraft Modeler*. The subject of this article was designed for the Profile Navy Carrier event, and its name was not chosen because Martin made a biplane variant of the MO-1—they didn't. It was chosen because the Bipe retains many of the construction features and the same general appearance of the MO-1.

In an era when the Scale Navy Carrier events were dominated by Guardians, the MO-1 was a most unlikely but highly successful choice for the event. The real airplane was to be a battleship based observation plane in the early 1920s. Only two ever saw Carrier service; an old letter reveals they were not regarded as fit for this service by the Navy. The MO-Bipe may appear an unlikely choice for Profile Carrier, but for a different reason. Most fliers do not normally think of a biplane for a Speed event.

Due to the nature of the rules, the biplane configuration, however unlikely it may seem, offers the very decided advantage of reduced weight and frontal area. A monoplane with a 36-in. span would require about an 8.5 in. chord to

Requirements for Profile Carrier allow non-scale designs.

A biplane can offer several advantages such as reduced weight and frontal area.

DON GERBER and HARRY HIGLEY

achieve the 300 sq. in. required by the rules. A few airfoil sketches will show that the minimum thickness that will maintain the structural integrity of a built-up wing is about .75 in. This gives a frontal area of about 27 sq. in. A wing this large does not lend itself well to solid construction. The MO-Bipe used two solid, easy to shape wings with a 28 in. span, 5.7 in. chord and .25 in. thickness. These give a total frontal area of 14 + sq. in., or only slightly more than half that of the monoplane. The Bipe will also have a shorter fuselage because of the reduced wing chord. This 15 to 25 percent overall reduction in fuselage dimensions will provide a substantial weight reduction. One last advantage for the biplane is the capability of using full span strip ailerons on the lower wing which eliminates the need for tip

weight, thus saving another ounce. Strip ailerons are easier to install than conventionally placed ailerons, as there is no need for long torque rods or clumsy pushrods. The importance of the working ailerons and rudder cannot be over-emphasized. This plane was designed from the ground up for Profile Carrier, but the full potential of the design cannot be realized unless the moveable ailerons and rudder are used.

Unusual construction features shared by the MO-1 and MO-Bipe include solid wings and easy to install semi-enclosed controls. Another common feature is variable sweep line leadouts. The less the lines sweep back, the faster the plane will go. However, the plane will be more likely to come in. By trying different holes in the tip guide, the most favorable line sweep may be found.

Full credit for the design belongs to Don Gerber. Don and I correspond regularly and this spring he sent some photos of the MO-Bipe and asked if I would be interested in a joint article, as he did not want to devote the large block of time that assembling an article such as this requires.

Construction

The construction procedure was planned to avoid two problems. First, a completely assembled biplane is dif-

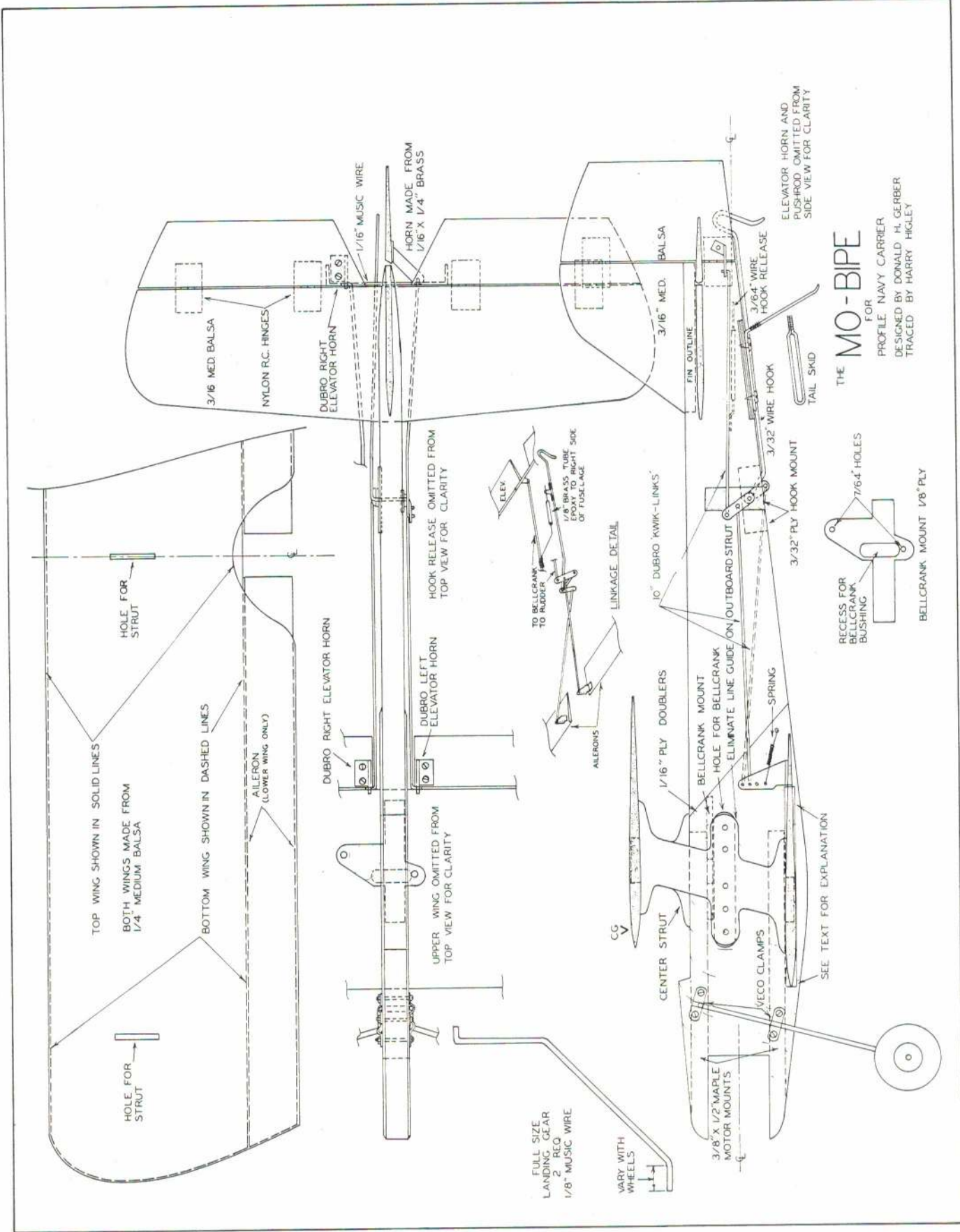

THE MO-BIPE
FOR
PROFILE NAVY CARRIER
DESIGNED BY DONALD H. GERBER
TRACED BY HARRY HIGLEY

FULL SIZE PLANS AVAILABLE - SEE PAGE 84

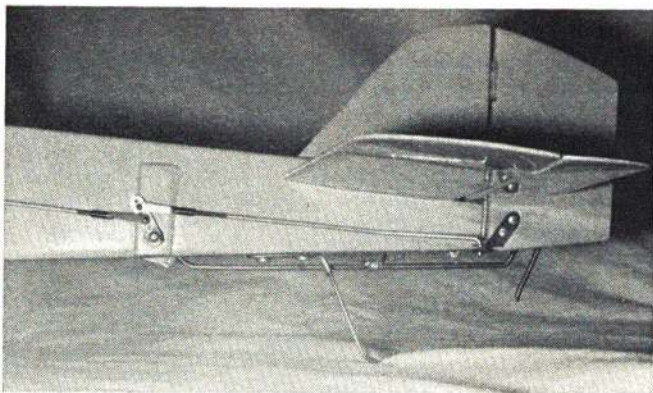

Above: All painting was done with linkages removed. This is also handy when crashes make major adjustments necessary.

Upper right: The MO-Bipe with its predecessor the MO-1, both in pre-WWII markings. Only the MO-1 has scale heritage.

Lower right: Adjustable leadouts provide for windy or calm conditions. Moved forward line tension is less but speed is higher.

Below: Plans show the hook-drop, elevator and aileron systems graphically. Note use of adjustable clevises throughout.

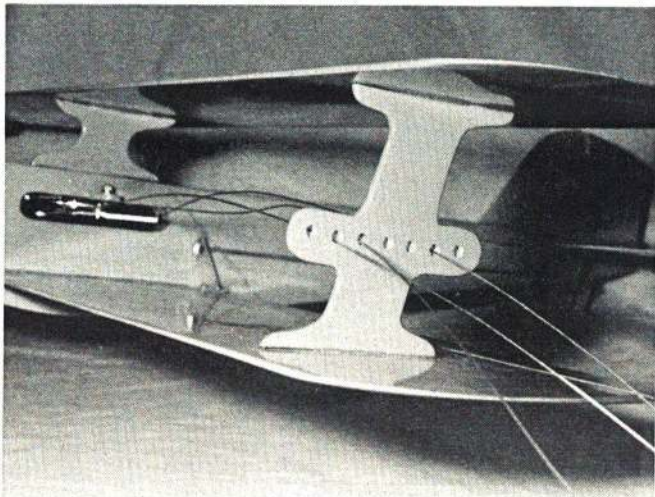
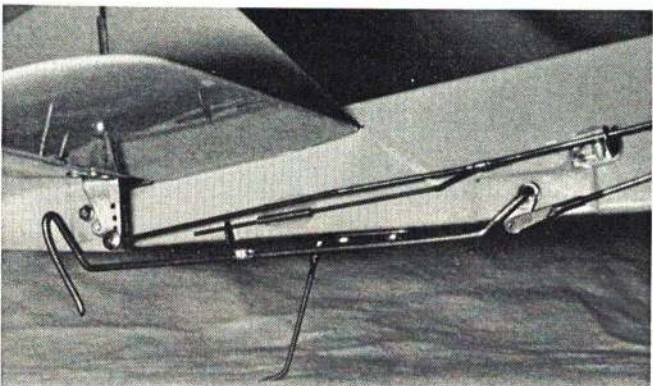

difficult to finish due to the limited space between the two wings. Second, painting after the controls are installed at best will look bad because of partially painted rods and other components; worse yet, the paint may foul the whole system. The strategy employed is to assemble the plane minus the upper wing and struts. The controls are then temporarily installed, checked, adjusted and then removed prior to finishing. The main frame, control surfaces, struts and upper wing are finished separately, and then the whole model is permanently assembled.

To begin with, cut all plywood parts. These include the bellcrank, hook and tail skid mounts, the struts and the plywood fuselage doublers. The doublers should be cut a little oversize as they may not end up in exactly the position they should. The resulting slight overhang is easily trimmed and sanded flush with the fuselage. Drill the required holes in the bellcrank mount, inboard strut, and tail skid mount.

Now is as good a time as any to bend the landing gear, tail skid and hook. Attach the wheels with soldered washers. Attach the tail skid to its mount with No. 6 x 3/8" sheet metal screws. This will facilitate easy removal of the skid for painting and replacement, though the latter will probably never be necessary.

The bellcrank on the J. Roberts unit must be shortened. Notice on this control unit that there are, in addition to the holes provided for the leadouts, two dents indicating alternate leadout positions. Drill at these points, then trim the excess from the bellcrank. Attach the leadout wires. I personally prefer Perfect brand—they are a little stiff, but are strong and solder well. Mount the control unit to the bellcrank mount to verify that the moveable bushing that is recessed into the mount has adequate clearance. Once this is established, remove the control system.

The next operation is fabricating the fuselage. Cut the motor mounts to the correct length. It will hurt nothing to drill 1/4" holes in them from the landing gear mount back; it will save some weight. Glue the bellcrank mount to the upper motor mount. Cut the fuselage from 1/2" sheet balsa. Choose this piece of wood carefully as a heavy sheet adds nothing but weight. Cut all slots including the bellcrank hole, except the one for the lower wing which will be cut after the doublers are installed. Cut the recesses for the hook mounts and the tail skid mount, and glue these in place. Glue the motor mounts in position. Notice on the plans that there is a piece of 1/2" wood on the top of the upper mount. Cut this from a scrap and glue it in place. The doublers may be attached

with contact cement or Titebond. If the latter is used, clamp between blocks, remove any excess glue with a wet rag, and allow to dry overnight.

After the fuselage assembly dries, it is convenient to drill holes for the motor, tank, hook and landing gear. If a drill press is used, it will be necessary to hold the fuselage on the block of wood so that the bellcrank mount clears the table. Trim the excess from the fuselage doublers and sand these even with fuselage.

Now the slot for the lower wing may be sawed. Hold the fuselage on a couple of blocks so the bellcrank mount clears the jigsaw table. The slot should be 1/4" and not the shape of the airfoil. The lower wing is left with a rectangular cross section where it intersects the fuselage. There are two reasons for this. First, it is difficult to cut a hole that will mate well with the airfoil. Second, sliding the fuselage onto the wing would surely nick and gouge the wing if the slot was a snug fit. Attach the landing gear.

The wings are made from 1/4 x 6" medium sheet balsa and are no more difficult to shape than a wing for a hand launched glider. Draw parallel lines on the top and bottom of each wing 1.75" from the leading edge and 2.5" from the

(Continued on page 72)

NEW from SCIENTIFIC

ROBERT E. LEE

MISSISSIPPI STEAMBOAT

A handsome museum quality wood ship model with carved wood hull and cast metal fittings.

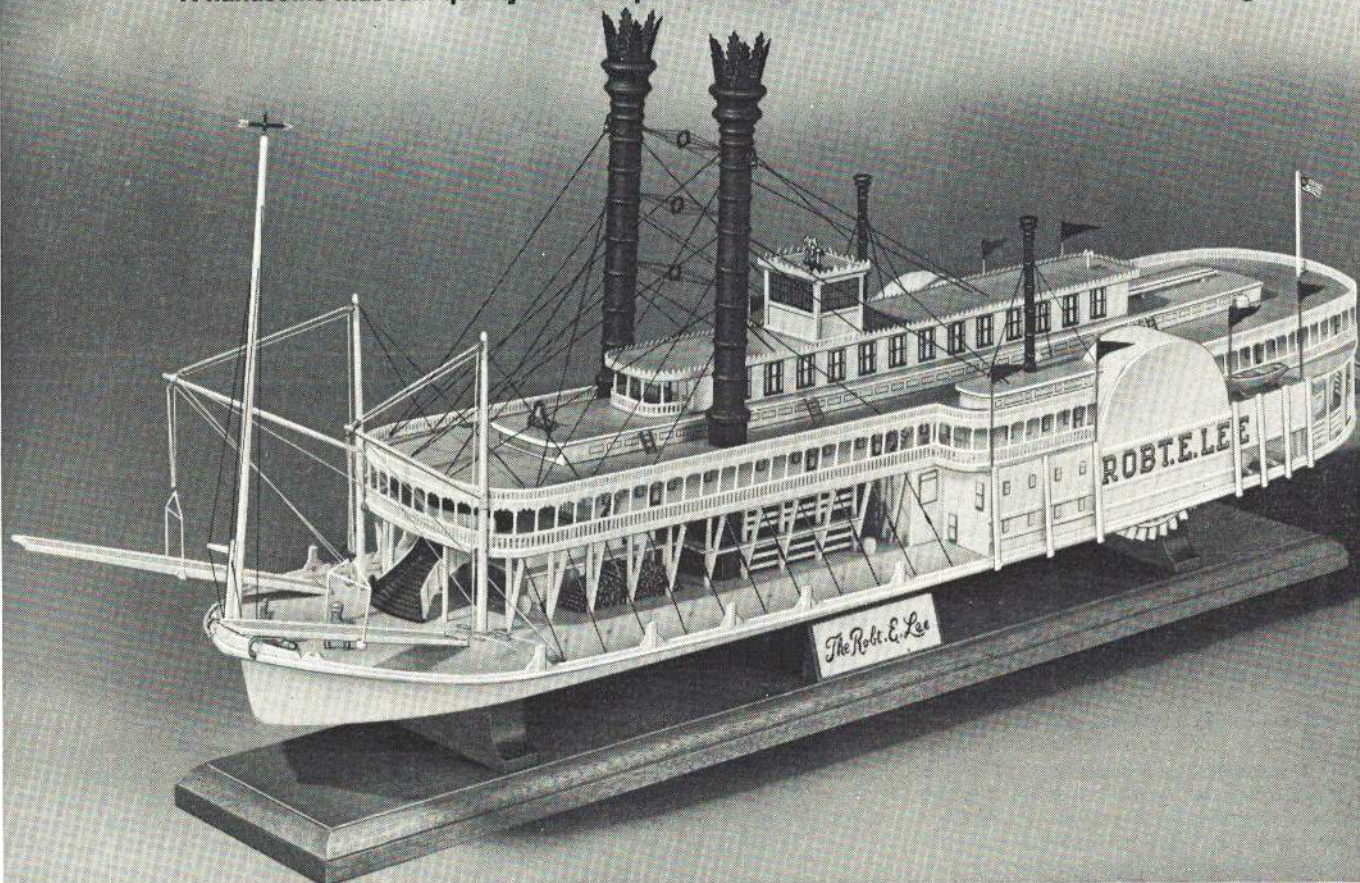

"NO MORE WAITIN' FOR THE ROBERT E. LEE" . . . IT'S HERE!

The most famous sidewheeler of them all is in a great new kit with all the trimmin's to make a scale replica. Months of research with material furnished by the Ohio Historical Society and the Louisiana State Museum make it authentic in every detail. And, anyone, even if they've never built a model before, can easily assemble it, using the easy-to-follow detailed instructions. Back in 1870, the Robert E. Lee was the fastest steamboat on the Mississippi. Now, it's a beautiful wood model Mark Twain would have been proud to own!

Our deluxe kit contains the finest materials available including:

- Pre-carved wood hull, all precision cast metal fittings including anchors, stairway, paddle wheels, ladders, lifeboats, chocks, etc.
- Pre-shaped Smoke Stacks
- Formed Deck Railing and pre-ruled scale Decking
- Colorful Decals and Pennant materials
- Mounting pedestals and beveled wood Display Stand
- Handsome metal nameplate
- Complete step-by-step instructions that make building easy even for the beginner.

KIT NO. 181

24½" Long, 6" Wide, 9" High

\$32⁹⁵

Send for our big colorful catalog . . 25¢

See Your Dealer. If kits are not available at dealer, you may order direct from factory adding \$1.00 for postage and handling. Outside U.S.A. add \$2.00

SCIENTIFIC

SCIENTIFIC MODELS, INC.

340CC Snyder Ave., Berkeley Heights, N.J. 07922

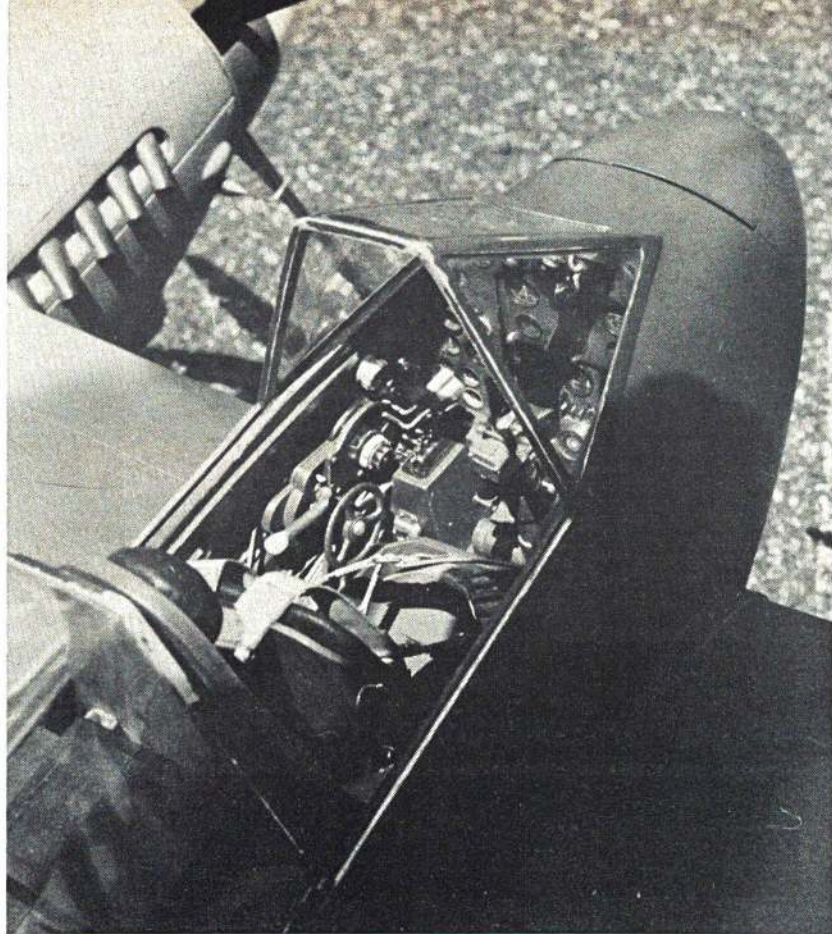

Scale World Championships

The team to represent the United States was selected at the 1971 Nats and included the top three winners in Control Line and RC Scale. For Control Line these were: Malvin Meador, Lexington Park, Md.; Mike Stott, Montezuma, Iowa; and Ralph Burnstine, Danville, Ill. For RC: Maxey Hester, Montezuma, Iowa; Bob Wischer, Delafield, Wisc.; and John Roth, Smithtown, N.Y. Team manager was Hale Wallace, Johnson City, N.Y. The team was accompanied by Control Line judge Andy Sheber, Livonia, Mich. Arrangement for transportation was made by the A.M.A. from New Jersey to Frankfurt, Germany where the team was met by Betty Roth, Charlotte Wallace, Dolly Wischer, Cathy Meador, and supporter Bob Elliott.

Two days were spent at Frankfurt, Germany to give the team members an opportunity to become accustomed to the time change and to rest before beginning the 600 mile trip to Toulouse, France, where the Scale Internats was to be held. Within minutes after our arrival at Frankfurt, we were met by two Ger-

Detail required for world level competition in CL or RC Scale is illustrated in photo above. Some instruments even work! U.S. teams placed 1st in RC and 4th in CL.

BOB WISCHER

man scale modelers, Bruno Klupp, who was a member of the German team, and Walter Reger. They brought a car and truck to solve our transportation problem for the six large model boxes and luggage. This was followed by an invitation from Bruno to visit his home where we spent an afternoon enjoying true German hospitality and browsing through his large, well-equipped workshop.

Bruno also arranged for our rental of

three Volkswagon Microbuses to be used for the trip to France. Imagine our surprise to find a Doylestown bumper sticker on one of them. With our model boxes crammed into two of the busses, along with luggage, and eight people in the other bus, we set forth for Toulouse. With the excellent navigation of Bob Elliott, we arrived two days later without becoming separated, in spite of having to contend with the heavy traffic of the peak continental vacation season.

At Toulouse we were provided quarters in a five-story dormitory at the E.N.A.C. Civil Flying School, just across the road from the airport which had a single runway and a large, smoothly paved control line circle. The models were placed on display in the school gymnasium—also the site for the static judging.

While judging proceeded quite rapidly, it was not without incident, as numerous modelers questioned the judges' interpretation of rules. The models of the Polish team were delayed in arrival from Paris and made their appearance after most of the judging had been com-



Dr. Jost Amman (left) with his Fairey Swordfish Mk-2. Same plane as flown in 1970 with much added detail. Placed fourteenth in RC.



Scandinaviska BHT-1 placed fifteenth in RC, flown by Swedish team member John Lyrseell. Digiflex radio.

Jacques Matter of France placed eighth in CL. DeHavilland Dragon Rapide with twin 19 engine.



U.S. Team Control Line entry of Ralph Burnstine, Douglas A-20G.



Leonid Barsukov, U.S.S.R. Control Line Team member flew Ilyouchine Stormovik. Highest flight score.



pleted. After their planes were judged, the U.S. and British teams were taken on a tour of the Sud Aviation factory where Concorde, Caravelles, and the new European Air Busses are under construction. The first roll-out of the Air Bus occurred minutes after our arrival.

Flying in the extreme heat of southern France proved to be quite hazardous, especially for those of us who come from cooler climates. On the day before flying began, Heinz Simon damaged his first place winning Messerschmitt Me-163 but it was completely repaired for his first flight. Incidentally, his plane is not taxied for takeoff. It is pulled into position by a radio controlled tractor. The engine is then started and the landing gear is jettisoned immediately after takeoff. Flight is very fast, resembling a high performance pattern ship. The engine is stopped on a belly skid.

Michael Reeves of England, the only contestant to fly both Control Line and RC, damaged both planes on their first flights. His CL entry, a Zlin Akrobat was not flown again, but his Cassutt Racer RC reappeared the next day with a rebuilt wing to take ninth place. Roy Yates had his Percival Proctor wiped out midway through its first flight. Bob Wischer's Emeraude snap rolled unexpectedly on takeoff but fortunately landed in a low tree. He spent the afternoon repairing a damaged wing and came back to place seventh. His one good flight was enough to give the U.S. RC team first place.

Maxey Hester with his well-proven Ryan ST Special did his usual superb job of flying. One of Simon's flights received a higher score than Maxey. John Roth had built a third Volksplane for the World Championship and this proved to be a wise choice, for in the

static event it was second by only 3½ points. With his strong background of experience flying this plane he finished in a tie for fourth place. In conjunction with Maxey's third place this made the U.S. team the one to beat.

Tied with Roth was our friend Bruno Klupp, flying his Piper Cherokee Arrow. Again it was evident that a well-tried plane had the edge in flying. Bruno's Piper had a new wing to give the plane a performance similar to a pattern ship. A small sacrifice in static points for the non-scale airfoil paid dividends in flight. Third man on the German team was Franz Ebermayr flying a North American T-28B. His flying was of high quality and consistent but placed eighth because of a low static score. Given more time to add details this plane will do better, and could easily have put the German team in first place.

If there was a popular favorite among the modelers, it would be Terry Melleney and his deHavilland 94 Moth Minor. The airplane was as detailed as possible, with wings that folded along the fuselage. Its flight was realistically slow, the maneuvers done with precision at low altitude. The plane had highest static points, flew consistently, but apparently did not succeed in dazzling the judges. Terry placed second in the individual standings.

After the static judging we were told that our models could remain in the school gymnasium and a wall receptacle was available for battery charging. The Swedish and Swiss teams used this receptacle and found, the next day, that when the lights were turned off, their battery chargers were also disconnected. As a result they lost their chance to fly under calm conditions in the first round. Later flights had windier conditions.

Jan Levenstam's SE-5 flew well enough to make tenth place, moving up from last place in the static standings. Also from Sweden, Jack Stromqvist flew a surprising P-51D Mustang. Everyone expected it to fly like the usual bomb, but it was flown very slowly, with almost no forward speed at touchdown.

From Switzerland came two beautiful biplanes, a Polikarpov Po2 by Werner Ruegger and a Fairey Swordfish Mk2 by Dr. Jost Amman. Ruegger did very well to finish sixth with a biplane. Both benefitted by the complexity factor in static scoring.

In Control Line the Poles and Russians battled for first place in the team standings, with Poland the winner. The Poles had good reason to be disturbed by the late appearance of their models for the scale judging as they were top contenders. The first place winner deHavilland Hornet of Jerzy Ostrowski was the same plane flown at the previous championship. In spite of its exposed engines it was judged best in the static event. The plane is very light for its twin 61 Mercos and the result is a truly aerobatic ship. Retract gear adds to realism. Its cockpit detail is as good as any seen at Toulouse, including some working instruments. Second in static as well as total standings was another Pole, Lech Podgorski, flying an Ilyouchine I12m3. This plane also had an exposed engine, but an extension shaft moved the engine rearward so that very little was visible. While Ostrowski managed his win with only one flight, Podgorski made all three flights and his third was best. The third member of the Polish team had also been a team competitor in 1970. Andrzej Uminski had a new plane, a Yakovlev YAK 18PS. A combination of mediocre flights and static score kept him to tenth place, but high



Cathy and Mal Meador prepare Mal's Spitfire Mk IIA. Seventh place in CL.

Control Line Brochet MB110 by Roland Barboyon of France.



Mike Stott prepares Meyers 145. Colin Jones at left. Flaps, retract gear, Ross twin 60 power.

Piper Cherokee Arrow by German Bruno Klupp. Same plane as in 1970 meet with new wing. Tied for fourth. Flies like Pattern ship.



Andrzej Uminski of Poland with CL Yakovlev YAK 18 PS.



North American T-28B. Eighth in RC. West German entry by Franz Ebermayr.

Mr. and Mrs. Michael Reeves await Mick's last flight. Cassutt Racer was damaged on first flight, repaired and finished ninth.



First place Control Line winner deHavilland DH 103 Hornet Mk 3 by Jerzy Ostrowski of Poland. Had retract gear, rockets.

Maxey Hester has Ryan ST in takeoff position. Hale Wallace, team manager, follows.



John Roth tied for fourth place with his Evans Volkplane. Northfield Ross Twin 60 engine and Kraft radio.



Robert Lestournaud guides the deHavilland of Terry Melleny during a takeoff under windy conditions.

Polikarpov Po-2 finished sixth in RC flown by Werner Ruegger of Switzerland.



Spectacular paint job on CAP 10B by Rene Fouquereau of France. Sixteenth place in RC.

enough to secure first place for the team.

New to World Championship competition was the team from the U.S.S.R. While none had spectacular scores, they managed a respectable second place in the team standings because of their consistency. In fifth place, Arkadij Chaevsky flew an Antonov AN-2 agricultural biplane. The plane was obviously old, as the fabric cover was checked and cracked. Possibly the judges regarded this as intentional since the plane was third in static. In sixth place was Leonid Barsukov, with the highest flight score of the meet, flying an Ilyouchine Stormovik 11-2. The plane had a finish that was too glossy and suffered from a very low complexity score. Boris Krasnorutsky's Petylakov PE-2 bomber finished in ninth place.

Mike Stott was the highest scoring U.S. entry placing fourth in static and final standings. Mike flew a Meyers 145 with Rom-Air retracts that were made to operate slowly for greater realism. Operational flaps and a wealth of detail—both external and cockpit—helped his score. Like most U.S. entries his photo and drawing presentation was complete. While the rules limit the quantity of photos, the judges were permitting any



Ryan ST by Colin Jones, South Africa. Model built in 14 weeks. Fourth place in Static event, eleventh place in total standings.



Miles Magister Control Line entry of British contestant Michael Staples.

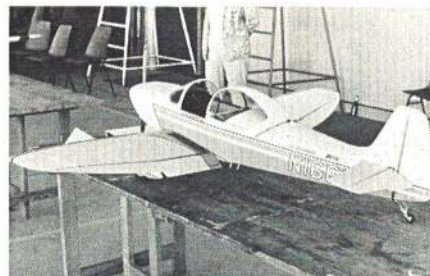

Seventh place Emerald RC by Bob Wischer. 9½ lb. Ross 60 engine, Royal radio. Crashed on first flight, repaired to continue flying.

Fairey Swordfish Mk-2. Swiss entry in RC by Dr. Jost Amman.

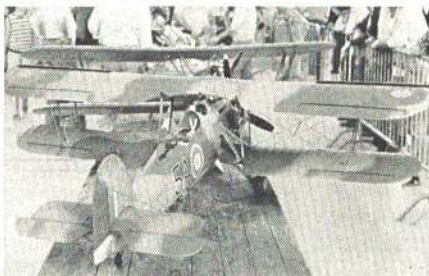

Roy Yates entered his Percival Proctor IV. Same plane as in 1970. Crashed on first flight.

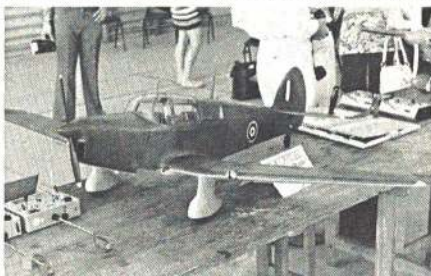

DeHavilland Tiger Moth placed tenth in CL for Derek Goddard of England.

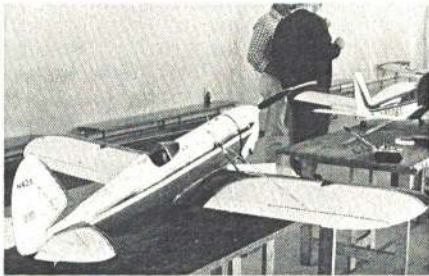

Two years old and still going strong, Ryan ST of third place winner Maxey Hester, who has flown in all three World Championships for U.S.



Antonov AN-2 by Arkadij Chaevsky of U.S.S.R. placed fifth in CL.



Messerschmitt Me-163 B1 German RC team entry by Heinz Simon. First place. Towed to takeoff by tractor, landed on belly skid with dead engine.

number. This may prove detrimental if the photos show detail not present on the model. Although Mal Meador won first place in the U.S. Nats with his Supermarine Spitfire Mk IIA, he finished seventh in both static and total scoring at Toulouse. Possibly this is the best example of the gradual upgrading that is constantly going on in our hobby and sport. The British, who feel somewhat possessive about a model of their Spitfire, were heard to comment that Mal's Spit was too clean. He had made an effort to show wear on the plane. Another victim of the oppressively high temperatures in Toulouse was Ralph Burnstine, our third member of the U.S. Control Line team. Ralph's Douglas A-20G had high temperature problems with its closely cowled engines.

Highest scoring of the French modelers was Claude Faix, whose Amiot 144M was the smallest of the meet. He made only one flight, with a high score and then retired, satisfied that it could not be improved. His static score was helped considerably by a high complexity factor. A DH 89a deHavilland Dragon Rapide by Jacques Matter and a Brochet MB110 by Roland Barboyon rounded out the French team.

Two years ago Mick Reeves was World Control Line Champ with his Zlin

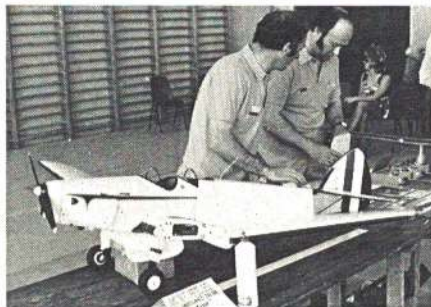

Terry Melleny and Roy Yates with Terry's deHavilland Moth Minor. Wing is in the folded position.

A fine weathered metallic finish on the P51-D Mustang entered in RC by Jack Stromqvist of Sweden.

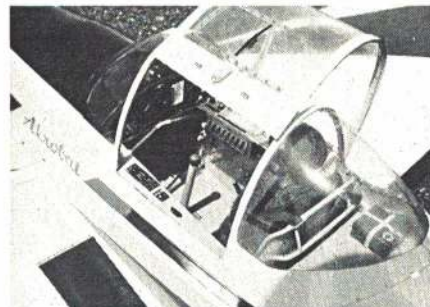

Finely detailed cockpit of Mick Reeves Zlin. Contains controls, first aid kit, legend plates.

The U.S. RC team planes. L to R: Maxey Hester's Ryan ST, John Roth's Volksplane, Bob Wischer's Emerald.



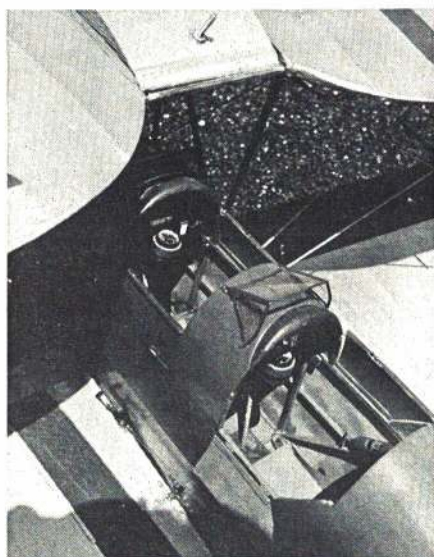

Left: Cockpit of Derek Goddard's deHavilland Tiger Moth. Highly detailed with long-rons and stringers visible, horizontal compasses, controls and fire extinguisher.

Below left: Heinz Simon uses electric starter on his Messerschmitt. First place in RC.

Above: Bruno Klupp of Germany with his RC Piper Cherokee Arrow. Flaps, retracts, complete interior. Tied for fourth.

Below: Heat was the enemy of Ralph Burnstine and his CL Douglas A-20G. Made only one flight because of engine problems.

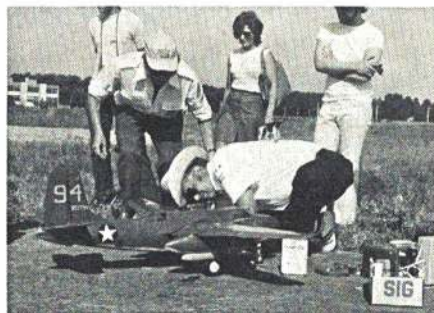
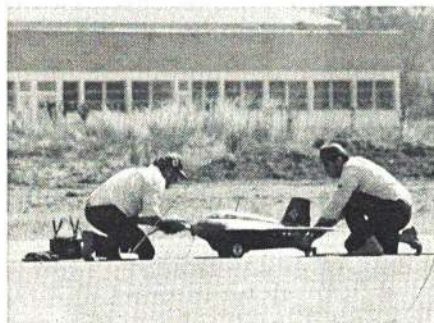

Akrobat. At Toulouse the model was sixth in static scoring which could have given him a second shot at the title. After his accident on the first flight, he apparently decided in favor of the Cassutt in RC and this meant that the U.K. Control Line team could do no better than fifth and last place. The Miles Magister of Mike Staples fell almost a thousand points behind the leader in static, an impossible lead to overcome. Derek Goddard's deHavilland Tiger Moth finished in tenth place. In Control Line flying it would appear that the reign of the United Kingdom was over.

Most impressive was the intensity of the modeling fervor of contestants. An example is Colin Jones of Rhodesfield Kempton Park in South Africa. Colin received the trophy for having come the longest distance, but this was the least of his achievements. In just fourteen weeks Colin duplicated Maxey Hester's Ryan ST, well enough to place fourth in static. He slept only four hours each night, and then couldn't sleep because of his total involvement in the construction. His business came to a halt. He was constantly under the watchful eye of the modeling organization. There was no time to become fully familiar with the plane before his arrival at Toulouse. On his third and final flight he succeeded in getting the model into the air and completed a flight, even making a respectable landing, which he never saw, because he collapsed there on the runway. Being an extroversive sort of person who could be putting on an act, there was no immediate reaction. His wife knew that it was not an act. Colin must be the most intensely enthusiastic RC modeler in the world. When we saw him the next morning he was leaving for a holiday in England, only slightly subdued.

Some additional thoughts about the contest: Flying Control Line and RC at the same time made an impossible situation for our busy team manager, Hale Wallace, and the same must have been true for the other managers. With proper organization these events could have alternated so that everyone could see both.

Crowd control could have been better. The Control Line fliers' lines were constantly being stepped on by people who should not have been near. The press had to pay for arm bands, and then found that anyone could get in to take pictures. It is probably unfair to compare with the superb organization at Doylestown.

On the plus side, the accommodations and flying site were the best seen anywhere. Weather was good for scale model flying. The dinner following the meet was in a beautiful setting, the modelers having the greatest time drinking from their trophies until four in the morning, toasting themselves and their rivals.

On Monday morning we said our goodbys in the dormitory and at breakfast in the cafeteria. We had made many new friends and the memories would be a part of our lives.

RC STATIC RESULTS

Place	Name/Nation	Fidelity	Craftsmanship	Complexity	Total
1.	Melleney/U.K.	1125	996.5	258.5	2,380
2.	Roth/U.S.A.	1104	1048	224.50	2,376.50
3.	Wischer/U.S.A.	1021	967	284	2,272
4.	Jones/R.S.A.	988	896.5	376	2,260.50
5.	Klupp/Germany	1003.5	893	287	2,183.5
6.	Simon/Germany	985	867	260	2,112
7.	Ruegger/Switz.	966.1	792.5	336	2,094.6
8.	Reeves/U.K.	1066	730	236	2,032
9.	Hester/U.S.A.	875	731	377	1,983
10.	Yates/U.K.	952.5	715	229.5	1,897.5

RC COMPETITION FLIGHTS INTERNATIONAL TEAM CLASSIFICATION

	1st Round	2nd Round	3rd Round	Total
United States	5745	5365.5	5184	16,294.5
Germany	5898	5365.5	4840	16,103.5
United Kingdom	5750	4527	3053	13,330

CL STATIC RESULTS

Place	Name/Nation	Fidelity	Craftsmanship	Complexity	Total
1.	Ostrowsky/Poland	1005.5	1004.5	399.5	2,449.5
2.	Podgorski/Poland	984	992	331	2,307
3.	Chaevsky/U.S.S.R.	972	986	347	2,305
4.	Stott/U.S.A.	984	963.5	246.5	2,194
5.	Faix/France	880.5	897	393	2,170.5
6.	Reeves/U.K.	933	894	310	2,137
7.	Meador/U.S.A.	844	874.5	260.5	1,979
8.	Matter/France	828.5	773	376	1,977.5
9.	Goddard/U.K.	890	767.5	266	1,923.5
10.	Uminski/Poland	857	784.5	260.5	1,902

CL COMPETITION FLIGHTS INTERNATIONAL TEAM CLASSIFICATION

	1st Round	2nd Round	3rd Round	Total
Poland	4120.5	3897	2801	10,818.5
U.S.S.R.	3643	3397	3154	10,194
France	3828.5	2935.5	2746.5	9,510.5

**MIDWEST
PRODUCTS CO.**



Norm Page's

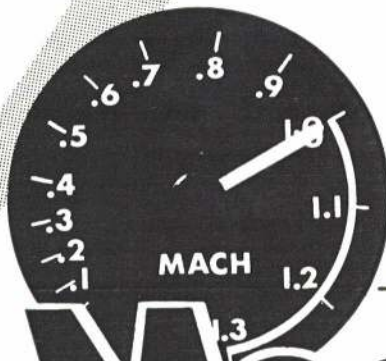

Mach 1

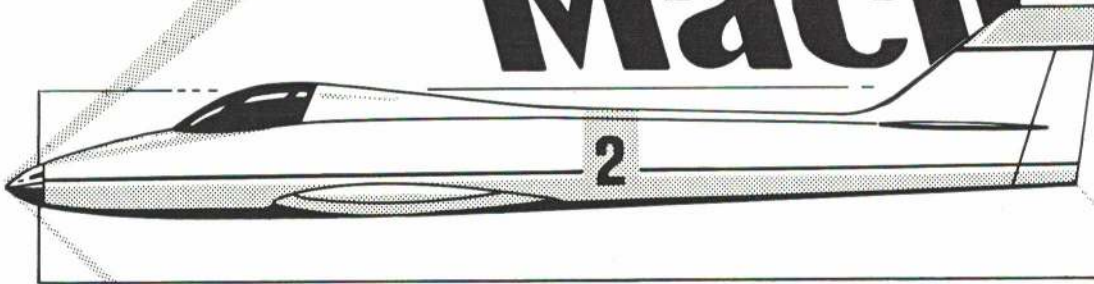

SLEEKEST DESIGN YET-COMPETITION PROVED

Moments, areas and airfoils all tested to perfection.

LONG LIST OF WINS including the

1972 'Masters' MEET!

Features:

- ★ BEAUTIFULLY CONTOURED
- ★ DIE CUT BALSA
- ★ DIE CUT PLYWOOD
- ★ SHAPED ENGINE MOUNTS
- ★ COMPLETE HARDWARE PACK
- ★ PRE-FORMED LANDING GEAR
- ★ FORMED-CANOPY, FILLETS and WHEEL WELLS (retracts optional)

Take *another* look at this sleek pattern ship, incorporating all the latest features for *smooth* flying. So impressive that literally dozens of scratch built versions are already flying. Join the top flyers — order yours *now* — the rush is *on!*

WINGSPAN	62 in.
AREA	725 sq. in.
WEIGHT	7½ lbs.
POWER	.60 cu. in.

KIT No. 127

\$49⁹⁵



Please send me your illustrated catalog of models and accessories
I enclose 25¢ to cover cost.

Name _____ Address _____

City _____ State _____ Zip _____

MIDWEST PRODUCTS CO.
400 South Indiana St. Hobart, Indiana 46342

FOR THE TENDERFOOT

Looking for something different? Well here it is and it is about as different as you can get! The O-FUNGLE is not just different, it's also a great flyer. Everyone will be fascinated by seeing this model fly. You can build the O-FUNGLE in just a couple of hours if you stick to it, and you shouldn't have any problems because it is so easy to build. Make sure to read all building and flying instructions before starting your model.

Construction

The wing is really the only part of the model that takes any time to build, but that figures because the wing makes up practically the whole airplane. To start with, select a couple of nice pieces of 1/32 sheet C-grain balsa. All surfaces of the wing will be made from these two pieces. The two sheets will be one of two-in. width and one of three-in. width. Make sure they are fairly light.

It is a normal airplane with
a unique shape.
In flight it looks like a donut.

JOEL RIEMAN

When the wood has been selected, trace the wing patterns on some typing paper. Next make the wing tips. Place the wing patterns on the wood—the wing tips on the two-in. wide piece and the wing center sections on the three-in. piece of wood. After the wing tips are made, make the wing center sections. When all of the wing is cut out, take one of the wing center section pieces and as on the plan cut off the elevator piece. Make sure the grain goes the right way.

Now that the wing is entirely cut out, you are ready to assemble it. Pin

down the wing center section pieces and then glue up the wing tips on each side.

When all the pieces are cut out, the wing is ready to be glued together. Pin down the wing center section pieces and then glue up the wing tips on each side. Each tip is to be raised up 1/4 in. Double glue the pieces before permanently gluing them by rubbing some glue in the porous areas of the wood and letting dry, then gluing them together. It will be much stronger if glued this way.

After the wing tips dry, glue the elevator on the same way with its back raised up 1/8" for lift as shown on the plan. After all parts of the wing are dry, put a couple of thin coats of glue around the joints for strength.

Now recheck your wing and make sure everything has been done in accordance with the directions and the plan.

(Continued on page 57)

Photos by Joel Rieman



O-FUNGLE

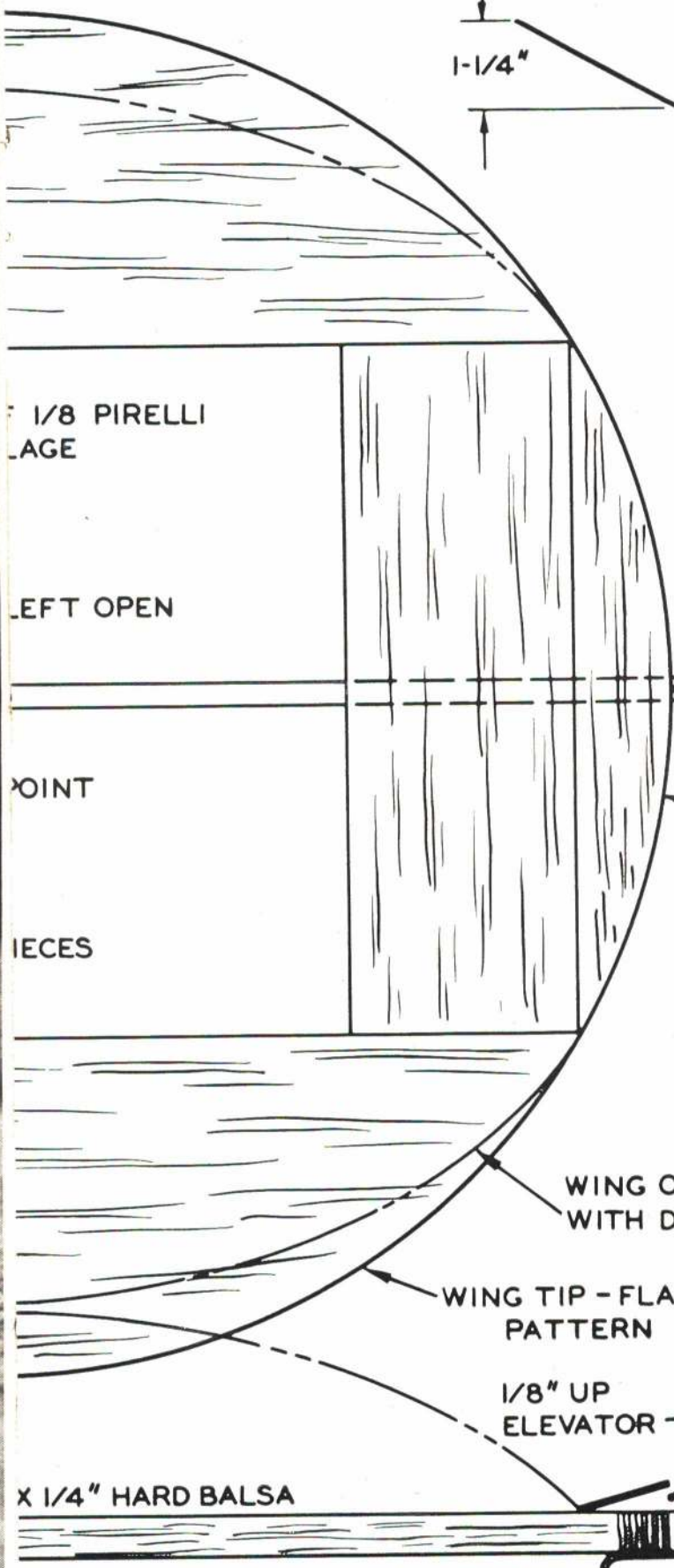
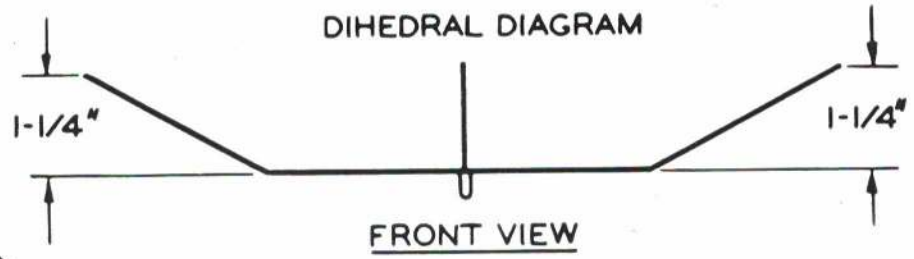

DO NOT DOPE!

MAKE SURE GRAIN IS GOING IN RIGHT DIRECTION

RUDDER

TAPER OFF

ELEVATOR

O-FUNGLE 

DESIGNED BY JOEL RIEMAN



RUDDER- 1/32" SHEET

PIN MOTOR HOOK

VIEW

A FEW OF THE NATIONALS WINNERS WHO U



Wayne Friebis
Hamburg, New York
1st Place Free Flight
FAI Power - Junior



Marylou Brown
Staten Island, New York
1st Place Control Line
1/2 A Speed - Open



Robert Lyons
Libertyville, Illinois

1st Place Free Flight
Rocket Power - Junior



Flaxen Johnson
West Covina, California
1st Place
Free Flight G

HERE IS THE BALSALAM THE CHAMPIONS USED!

STICKS - 36" Lengths		SHEETS - 36" Lengths		BLOCKS - 3" Lengths		BLOCKS - 18" Lengths		BLOCKS - 6" Lengths		BLOCKS - 24" Lengths	
1/16 x 1/16	.04	1/32 x 2	.26	1 x 1	.08	1 x 1	.39	1 x 1	.14	1 x 1	.53
1/16 x 1/8	.05	1/16 x 2	.28	1 x 2	.14	1 x 2	.77	1/2 x 2	.18	1 x 2	.102
1/16 x 3/16	.06	3/32 x 2	.34	2 x 2	.20	1 x 2	.77	3/4 x 2	.22	2 x 2	.145
1/16 x 1/4	.07	1/8 x 2	.39	1 x 3	.20	1 x 3	1.08	1 x 2	.27	1 x 3	.145
1/16 x 3/8	.09	3/16 x 2	.46	2 x 3	.27	2 x 2	1.10	1 1/2 x 2	.33	2 x 2	.145
1/16 x 1/2	.11	1/4 x 2	.60	3 x 3	.44	1 x 3	3.10	2 x 2	.37	2 x 2	.145
1/16 x 3/4	.14	3/8 x 2	.69	1 x 4	.14	2 x 3	3.10	1/2 x 3	.24	2 x 3	.216
1/16 x 1	.18	1/2 x 2	.87	1 x 1	.14	3 x 3	2.42	1/4 x 3	.34	3 x 3	.328
3/32 x 3/32	.06	3/8 x 4	.98	1 x 2	.14	1 x 4	1.38	1/2 x 4	.49	1 x 4	.193
3/32 x 3/16	.08	1/2 x 3	.37	1 x 3	.20	2 x 4	2.20	1/4 x 4	.74	2 x 4	.292
3/32 x 1/4	.09	1/20 x 3	.39	1 x 3	.20	2 x 4	2.20	3/4 x 4	.82	3 x 4	.435
3/32 x 3/8	.10	1/16 x 3	.39	2 x 3	.27	3 x 4	3.30	1 x 6	.80	1 x 6	.295
3/32 x 1/2	.13	3/32 x 3	.49	3 x 3	.44	1 x 6	2.25	1 1/2 x 6	.96	2 x 6	.440
3/32 x 3/4	.18	1/8 x 3	.55	1 1/2 x 3	.46	2 x 6	3.40	2 x 6	.80	3 x 6	.667
3/32 x 1	.20	1/8 x 3	.55	1 1/2 x 3	.46	3 x 6	4.90	1/2 x 6	.96	1 x 8	.390
1/8 x 1/8	.07	5/32 x 3	.61	2 x 3	.27	1 x 8	2.80	3/4 x 6	3.45	2 x 8	5.90
1/8 x 3/16	.08	3/16 x 3	.66	3 x 3	.44	2 x 8	4.50	1 x 6	4.25	3 x 8	6.70
1/8 x 1/4	.09	1/4 x 3	.87	1 1/2 x 3	.46	3 x 8	6.70	1 1/2 x 6	5.35	1 x 8	6.25
1/8 x 3/8	.13	5/16 x 3	.95	2 x 3	.51	1 x 8	4.50	2 x 6	6.25	3 x 8	9.50
1/8 x 1/2	.16	3/8 x 3	1.04	2 x 3	.51	2 x 8	4.50	1/2 x 8	4.25	1 x 8	6.25
1/8 x 3/4	.20	1/32 x 4	.55	3 x 3	.85	3 x 8	6.70	3/4 x 8	4.75	2 x 8	6.25
1/8 x 1	.22	1/16 x 4	.55	1/2 x 4	.36	1 1/2 x 4	.63	1 x 8	5.25	1 1/2 x 8	7.00
3/16 x 3/16	.10	3/32 x 4	.61	3/4 x 4	.43	2 x 4	.74	2 x 8	5.25	2 x 8	8.60
3/16 x 1/4	.12	1/8 x 4	.77	1 x 4	.49	1 1/2 x 4	.63	3 x 8	9.50	3 x 8	12.50
3/16 x 3/8	.14	3/16 x 4	.88	1 1/2 x 4	.63	2 x 4	.74	1 x 8	9.50		
3/16 x 1/2	.20	1/4 x 4	.98	2 x 4	.74	3 x 4	1.09	2 x 8	9.50		
3/16 x 3/4	.23	1/2 x 4	1.30	3 x 4	1.09	1/2 x 6	.55	3 x 8	9.50		
3/16 x 1	.28	1/32 x 6	1.08	1/2 x 6	.55	3/4 x 6	.68	1 x 6	9.50		
1/4 x 1/4	.16	1/16 x 6	1.08	3/4 x 6	.68	1 x 6	.80	2 x 6	9.50		
1/4 x 3/8	.19	3/32 x 6	1.24	1 x 6	.80	1 1/2 x 6	.96	3 x 6	9.50		
1/4 x 1/2	.21	1/8 x 6	1.29	2 x 6	1.05	2 x 6	1.05	1 x 8	9.50		
1/4 x 3/4	.28	3/16 x 6	1.50	3 x 6	1.75	3 x 6	1.75	2 x 8	9.50		
1/4 x 1	.35	1/4 x 6	2.00	1 1/2 x 8	1.38	3 x 8	8.80	3 x 8	9.50		
5/16 x 5/16	.19	3/8 x 6	2.30	1 x 8	1.38						
5/16 x 3/8	.25	1/2 x 8	1.38	3/8 x 8	2.85						
5/16 x 1/2	.30	1/16 x 8	1.38								
5/16 x 5/8	.36	3/32 x 8	1.48								
5/16 x 1	.42	1/8 x 8	1.80								
3/8 x 3/8	.22	3/16 x 8	2.05								
3/8 x 1/2	.29	1/4 x 8	2.25								
3/8 x 3/4	.38	3/8 x 8	2.85								
3/8 x 1	.48										
1/2 x 1/2	.33										
1/2 x 3/4	.44										
1/2 x 1	.55										
5/8 x 5/8	.39										
5/8 x 1	.61										
3/4 x 3/4	.53										
3/4 x 1	.68										



Pint \$1.85 WITH HARDENERS

KWICK-SET



VH - VERY HARD
1/16 x 3 44
3/32 x 3 54
1/8 x 3 60
3/16 x 3 71
1/4 x 3 92
3/8 x 3 109

LEADING EDGE
36" Lengths
3/8 x 1/2 33
1/2 x 1/2 39
3/4 x 3/4 60
1 x 1 85

36" TAPERED TRAILING EDGE
1/8 x 1/2 21
3/16 x 3/4 24
1/4 x 1 32
5/16 x 1 1/4 38
3/8 x 1 1/2 44

36" WING SKINS
1/16 x 12 2.25
3/32 x 12 2.55

B
C
SE
Ai
*
*

USED SIG BALSA



Johnson
na, California
Place 1/2 A
Gas - Junior



Mark Kummerow
LaGrange Park, Illinois
1st Place Free Flight
C Gas - Senior

SIG AIRCRAFT PLYWOOD

VERY TOUGH, FLAT BIRCH PLYWOOD

LAMINATED WITH WATERPROOF GLUE. SIG AIRCRAFT PLYWOOD CAN BE USED ANYWHERE THAT GREAT STRENGTH IS REQUIRED.

SPECIAL 3-PLY PLYWOOD

1/8 x 6 x 12	\$.40
1/8 x 12 x 12	\$.80
1/8 x 12 x 24	\$1.60
1/8 x 12 x 48	\$3.20

1/32" AND 1/16" ARE THREE-PLY 3/32", 1/8", 3/16" AND 1/4" ARE FIVE-PLY

1/32 x 6 x 12	\$.45
1/16 x 6 x 12	\$.50
3/32 x 6 x 12	\$.60
1/8 x 6 x 12	\$.65
3/16 x 6 x 12	\$.65
1/4 x 6 x 12	\$.65

1/32 x 12 x 12	\$.90
1/16 x 12 x 12	\$1.00
3/32 x 12 x 12	\$1.20
1/8 x 12 x 12	\$1.30
3/16 x 12 x 12	\$1.30
1/4 x 12 x 12	\$1.30
1/32 x 12 x 24	\$1.80
1/16 x 12 x 24	\$2.00
3/32 x 12 x 24	\$2.40
1/8 x 12 x 24	\$2.60
3/16 x 12 x 24	\$2.60
1/4 x 12 x 24	\$2.60
1/32 x 12 x 48	\$3.60
1/16 x 12 x 48	\$4.00
3/32 x 12 x 48	\$4.80
1/8 x 12 x 48	\$5.20
3/16 x 12 x 48	\$5.20
1/4 x 12 x 48	\$5.20

SIG LITE-PLY



A VERY LIGHT 3-PLY 1/8" POPLAR PLYWOOD FOR USE WHERE MAXIMUM STRENGTH IS DESIRED

BUT AIRCRAFT PLYWOOD IS TOO HEAVY. IDEAL FOR FUSELAGE SIDES, CABIN FLOORS, SERVO COMPARTMENTS, ETC. HEAVIER THAN BALSA BUT ABOUT HALF THE WEIGHT OF OUR REGULAR

AIRCRAFT PLYWOOD.

1/8 x 12 x 12	\$.40	1/8 x 12 x 36	\$1.20
1/8 x 12 x 24	\$.80	1/8 x 12 x 48	\$1.60

1/64" PLYWOOD FOR WING SKINS

Three Paper-Thin Veneers Laminated With Waterproof Glue. Make Excellent Foam Wing Skins or Many Other Uses In Model Aircraft Construction.

12" X 12"80	12" X 48" . . .	3.20
12" X 24" . . .	1.60	24" X 48" . . .	6.40

EASY TO USE - CAN BE CUT WITH ORDINARY SCISSORS LIKE PAPER

ADHERE WITH SIG CORE-BOND

BRUSH ON



FINISHING RESIN

FOR A SUPER-SMOOTH FINISH

A SPECIALLY PREPARED RESIN FOR FILLING BALSA, SILK OR OTHER FABRIC

CREATES A GLASS-SMOOTH BASE FOR DOPE OR ENAMEL

- * EASY TO APPLY
- * SETS QUICKLY
- * EASY TO SAND
- * LOW COST

HARDENER

Quart \$3⁵⁰

WITH HARDENER

QUICK SET EPOXY GLUE

SETS UP IN FIVE MINUTES

Specially Formulated For Model Airplane Construction And Repair

* QUICK

2 oz. \$1⁵⁹

* STRONG

* FLEXIBLE

* FUEL PROOF

Epoxy Glue should be used anyplace that extra strength is needed, such as firewalls, engine bearers, landing gear mounts, and the interior of the engine compartment. Sig Kwick-Set is also very valuable for field repairs as it gives an extremely strong bond in just five minutes. It should be in every modeler's field box.



Send \$1.00 Today for
SIG'S BIG NEW CATALOG!
The Modeler's Wishbook™

NO POSTAGE REQUIRED WHEN ORDERING CATALOG ALONE

THE 1972 FALL AND WINTER SIG CATALOG is the greatest Model Airplane Catalog yet! Over 244 pages, with sixteen pages in full color, devoted exclusively to merchandise used in the building or flying of model airplanes. Features the complete Sig Line, plus practically all other lines available. Hundreds of models are illustrated, including gliders, sailplanes, rubber-powered flying scale, control line stunt and scale, and every type of R-C model. Send \$1.00 today for your copy or buy it from your local hobby dealer. You will agree that it is the best bargain in the model airplane industry.



ORDERING
INSTRUCTIONS



SEE YOUR DEALER FIRST! If he will not supply you, then order directly from our plant. We will ship promptly. To Order, please add \$1.00 for postage and handling in the U. S. Canadian orders please add \$1.50. Minimum order is \$1.00. Please remit by bank draft, check or money order. Print your name and address plainly. Sorry, No C.O.D. shipments. All prices subject to change without notice.

SIG MANUFACTURING CO., INC
401 S. FRONT STREET
MONTEZUMA, IOWA 50171

WING DIVIDED INTO PIECES -
USE 1/32" SHEET C-GRAIN BALSA

WING OUTLINE
WITH DIHEDRAL

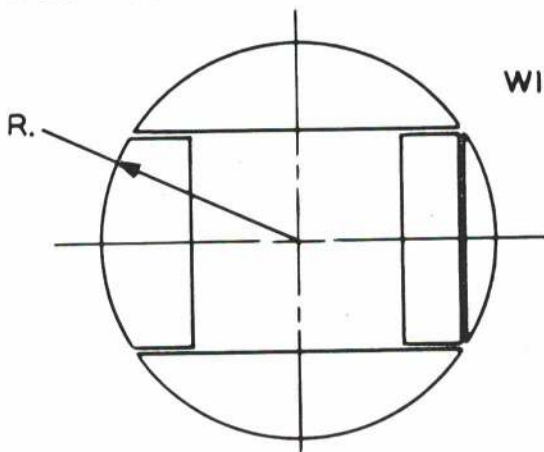

WING TIP - FLAT
PATTERN

WING CENTER SECTION

FUSELAGE ROUNDED
ON BOTTOM



DOUBLE GLUE AT ALL JOINTS

PROP SHAFT 1/32" MUSIC WIRE

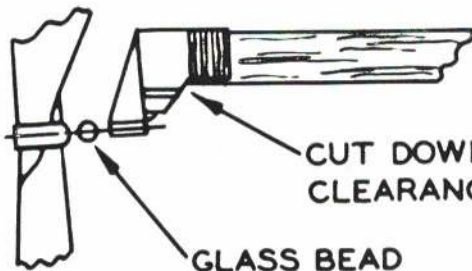

SLEEK STREEK
PROP ASSEMBLY



POWER - 1 LOOP OF
AS LONG AS FUSE

THIS AREA

BALANCE

TWO SEPARATE P



Simple lines and little balsa make the O-Fungle great evening building entertainment.

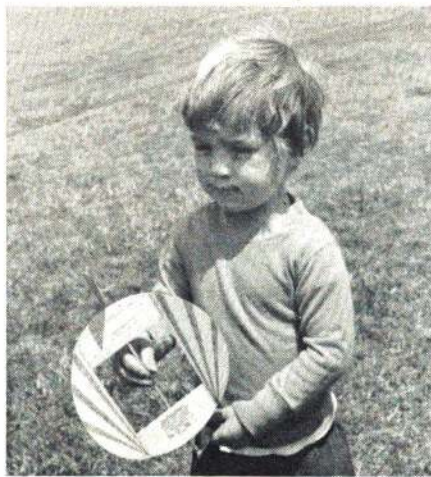

Guess who got to the landing spot first? A new Tenderfoot.

The fuselage and rudder are quite simple to construct. The fuselage is simply a piece of 1/8 x 1/4 hard balsa. After you have picked a nice piece of wood for the fuselage look at the plan and cut the fuselage stick down to size. Now sand in a rounded shape to the bottom of the fuselage for more streamlined flight, though it is not really necessary.

Taper off the back of the fuselage past the motor hook shown on the plan, making sure you don't taper it too much. Cut a rudder out of the 1/32 sheet by first making a pattern like you did with the wing and using it to cut out the rudder piece.

You are now ready to put the motor hook in. Simply take a pin and bend it to the shape on the plan with a pair of needle nose pliers. When you have the motor hook bent, stick it into the fuselage in the position shown on the plan. Make sure that you do not put the pin back any further because it could cause the fuselage to snap in half when winding. With the pin in place, wrap it with thread and put a thin coat of glue around the thread.

The prop assembly is the next step. Buy a 29-cent Sleek Streak and get the prop out of that. Before installing, you must make a couple of provisions. First, get some wire cutters and cut off the prop shaft because it is too small. Now out of 1/32 music wire make a new prop shaft, following the diagram on the plan. Take the plastic nose piece and cut off the portion shown on the plan for clearance. Slip the new prop shaft through the nose piece and then put on a small plastic bead to keep the prop from hitting the nose of your model. Now slip the prop on the prop shaft and bend the end of the prop shaft over to hold on the prop. Make sure you don't bend it all the way around the side of the prop as then it won't be free-wheeling. Now put a little glue in the nose piece and slip on the fuselage. Wrap thread around the nose just as you did on the motor hook, and put a coat of glue around it.

There really isn't much to the assembly, except gluing on the wing and the

rudder. To glue on the wing, put a little glue on the wing and the fuselage and double glue as you did in making the wing. When the wing is dry on the fuselage, glue the rudder on and you will be finished.

Flying

The first thing you have to do is get your model balanced. Hold the plane by the edges of the wing in line with the balance point indicated on the plan. Do this by putting clay on the nose until it balances level.

Now check and see if there are any warps in your model. Make sure there are none before you start flying your model because it will cause it to fly out of control.

After you are sure it has no warps, start test gliding it. Your model should need a little clay on the nose to keep it from stalling. It is unlikely, but if your model dives, take a little clay off the nose or if it has no clay on the nose give it a little more up elevator. You should have no problems getting it to fly if it is built properly. If your model dives to the side in a sharp turn, carefully bend the rudder the opposite way or put a small typing paper tab on your rudder to help it turn. If it just turns one way a little too sharply, put a little clay on the opposite wing.

To power your model use 1/8 Pirelli, or 1/8 brown rubber. If Pirelli is used you can get more power into your flights. 1/8 Pirelli rubber can be obtained in packs of 15 ft. for 81 cents (that includes postage and tax) from W.C. Hannan Graphics, P.O. Box A, Escondido, Calif. 92025. Make one loop as long as the fuselage, and lubricate with a mix of 1/2 green soap and 1/2 glycerin. This will allow you to give it more winds and it will give the rubber a longer life. Before you fly it you can oil the prop shaft to let the prop turn more freely. A good 1/16 ratio winder will make the job a lot easier. A Marlow winder can be obtained from your local hobby shop. Now try some power flights. Make an adjustment on every flight.



QUALITY U-CONTROL BALSA KITS

28½" Wingspan **\$15.00**
Each Kit

- No. 201 P-40 E Curtiss
- No. 202 P-51-D Mustang (illus.)
- No. 203 Messerschmitt ME-109
- No. 204 Zero Fighter
- No. 205 Spitfire 5B
- No. 206 A1H Sky Raider
- No. 207 F-6F Hellcat
- No. 208 F-4U Corsair
- No. 209 Cessna 182
- No. 210 Hurricane

Above group for .15 to .19 engines

36" Wingspan **\$18.00**
Each Kit

- No. 301 P-51 Mustang
- No. 302 Cessna 172
- No. 303 F8F Bearcat
- No. 304 AD-4 Skyraider
- No. 305 Spitfire
- No. 306 Messerschmitt

*For
.29 to .35
engines*



P-38 KIT -

\$20.00
FOR .29-.35 ENGINES Each Kit

- No. 307 T-6 Texan (41" Wingspan)
- No. 308 P-40 Warhawk (38" Wingspan)
- No. 401 P-38 (Uses two 12-29 engines. 40" wingspan.) Illustrated

ORDER DIRECT

AT THESE LOW PRICES!

All Kits have full scale plans in English. Landing Gear and Wheels. Pre-cut balsa and plywood parts ready to assemble. Metal cowl and plastic canopy where needed.

Send check or money order for direct, prompt shipment. All California orders must add 5% sales tax. Satisfaction is guaranteed.

KAYEFF, INC.

511 Campesina Road
Arcadia, California 91006



AN RC RPV

Early in 1971, I received a call from old-time modeler Bob Palmer who works for the Lockheed California Co. They were undertaking a program of research on remote piloted vehicles (RPVs) as potential combat vehicles. For government oriented research, it was a very low budget effort.

As a feasibility demonstration, they proposed to undertake an approximate 1/10 scale flight demonstration program to learn more about the capabilities, and limitations, of RPVs. How precisely can the flight path be controlled? Is air-to-air combat feasible, or would the initial target acquisition be too difficult? And a lot of other questions.

Lockheed had earlier developed a small, lightweight experimental TV camera, and a matching lightweight transmitter. So, the idea emerged—mount the camera and transmitter in a radio-controlled airplane, and try to fly the airplane entirely by reference to the picture transmitted by the camera to a monitor screen receiver installed inside a mobile van.

Lockheed's first and most basic test of the remotely piloted vehicle used a large RC model.

KEN WILLARD

Bob called me, on behalf of the program manager, to inquire about the availability of a couple of Wavemasters, the amphibian six ft. RC airplane which I had designed and which is produced in kit form by King R/C Distributors.

We talked about the problems—space envelope, weight and balance, power requirements, structural beefups. The Wavemaster is designed to fly at weights ranging from eight to nine lbs. in normal use. With the TV camera installed (including transmitter and power pack), it would have to fly at around 15 lbs., according to original estimates. Actually, by the time all the modifications

were added, the flying weight turned out to be closer to 20 lbs.!

At the time of Bob's call, I had just completed most of the flight test program on the Wavemaster and had two prototypes available. As soon as we determined the camera would fit in the nose (ahead of the propeller as desired) and there was room for all the equipment, I shipped the two airplanes down to the Rye Canyon test facility. There they modified the landing gear to carry the added weight and also extended the wing to eight ft. span. This concerned me, as I feared the percentage of stab area might be marginal. But flight tests eliminated the need for any concern—the airplane was very stable.

To perform the actual flight program, two of the best known and best qualified RC pilots in the world were selected. Larry Leonard and Bob Smith, familiar names to all RC enthusiasts, took on the assignment. Although the plane was able to fly with a 61, even weighing nearly 20 lbs., it was understandably a bit sluggish. So an 80 was

(Continued on page 88)

1 The target was simulated 1/10 size airfield with hangars and revetments.

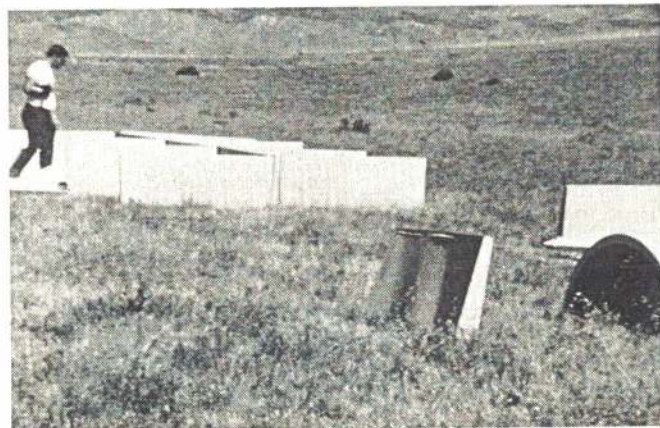

2 Larry tweaks the needle while Bob holds. Buddy-boxed transmitters used for flight until target acquisition by monitor-only guided pilot.

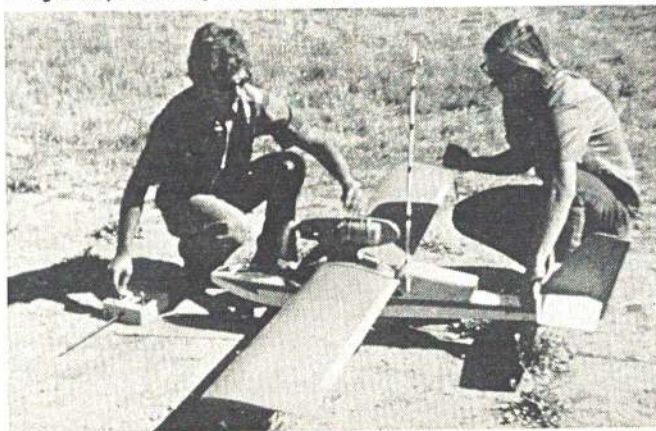

LEFT Much modified Wavemaster now weighs 20 lb. and has O.S. 80 for power. Camera is in nose and TV transmitter located behind wing.



3 Takeoff at 20 lb. plane's level flight was 60 mph.

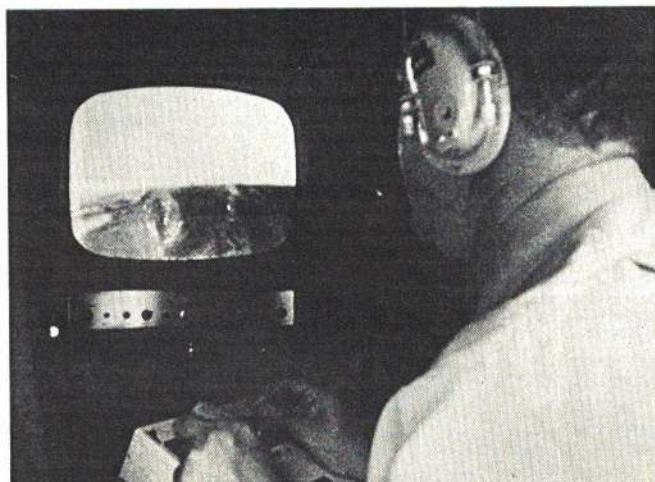

4 Control switched to TV-guided pilot at this instant. He has target in sight at lower left edge of TV screen.

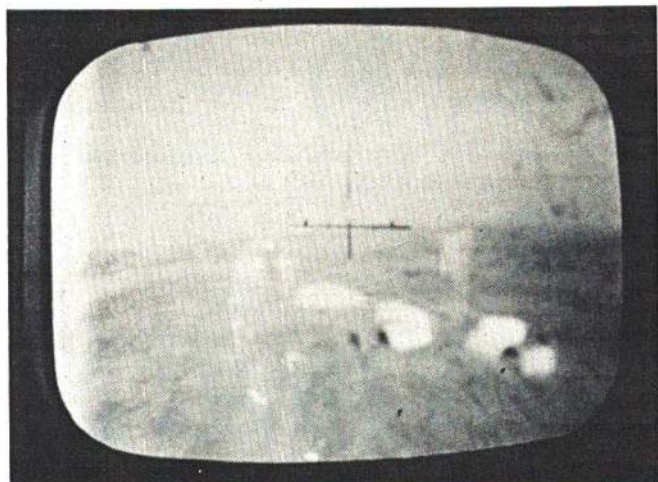

5 Strafing run at 15 ft. over the scaled-down airfield. Looks like fun.

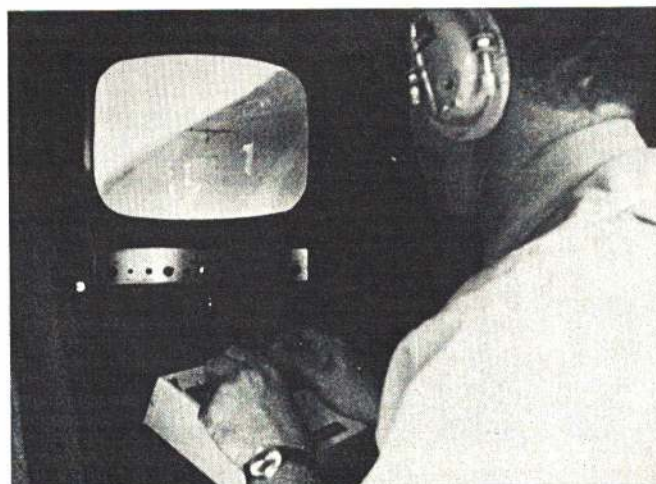

6 Climbing out in a right turn after the attack. As soon as the horizon disappears, control is transferred to pilot standing outside van.

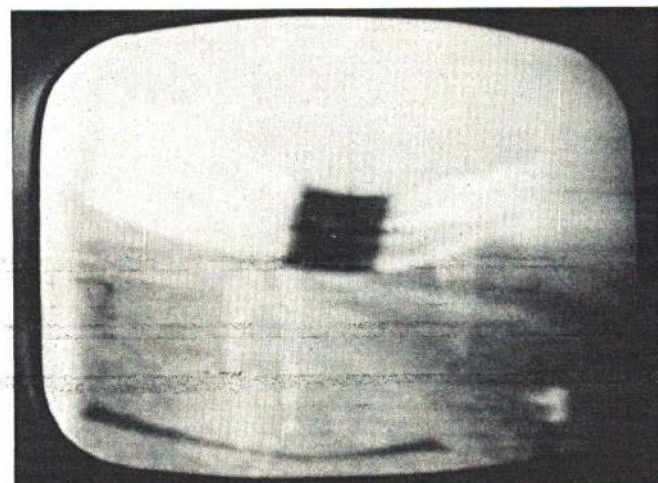

7 Accuracy test was flight into pole-supported crepe banner with bull's eye.

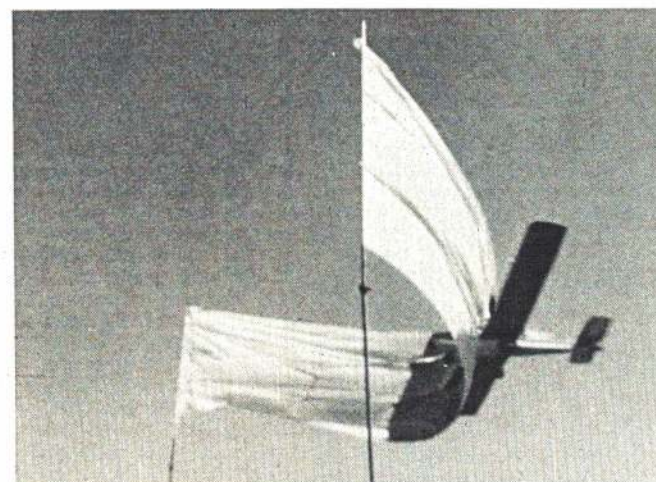

8 Here's the moment of impact. Unfortunately the target won by wrapping itself around the model.

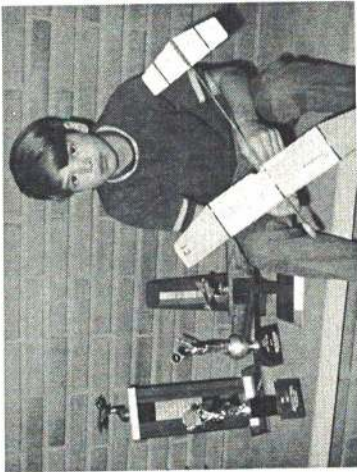

MRS BEASLEY

by Bob Pione

- Contest Record—Jr OHLG—Gary Pione
 1st 1968 Cleveland Jr Air Races
 1st 1969 Nationals (5:03)
 2nd 1969 Cleveland Jr Air Races
 2nd 1969 Tenn State Championships
 2nd 1969 Canton, Ohio Model Society

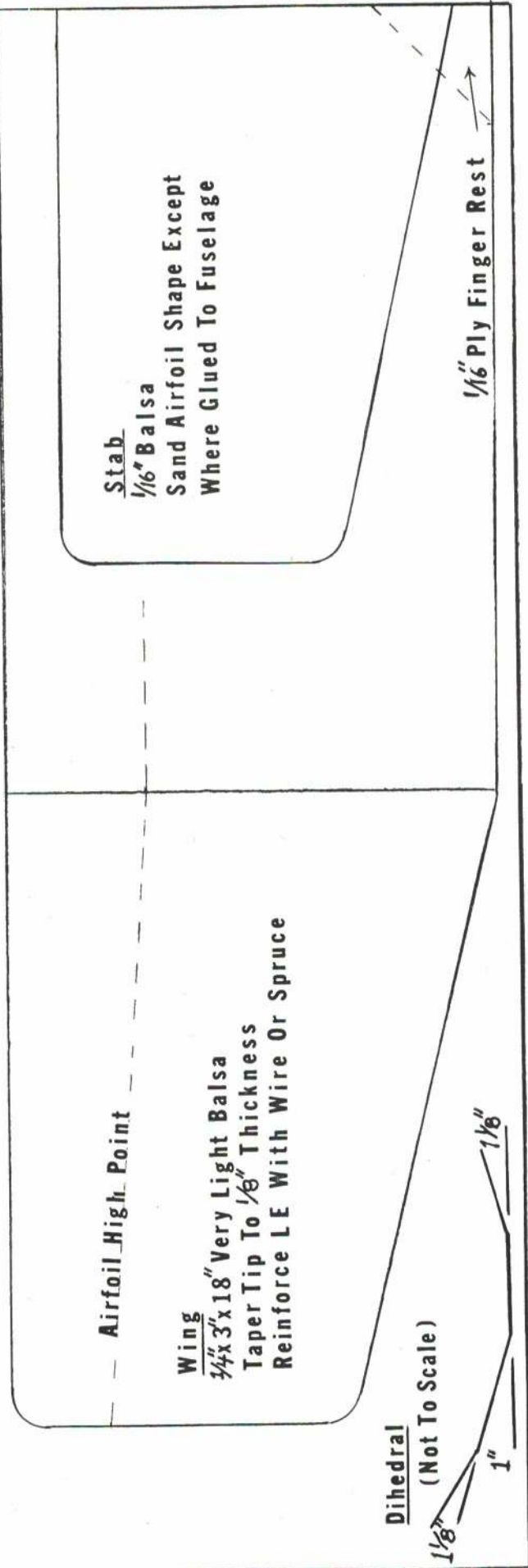
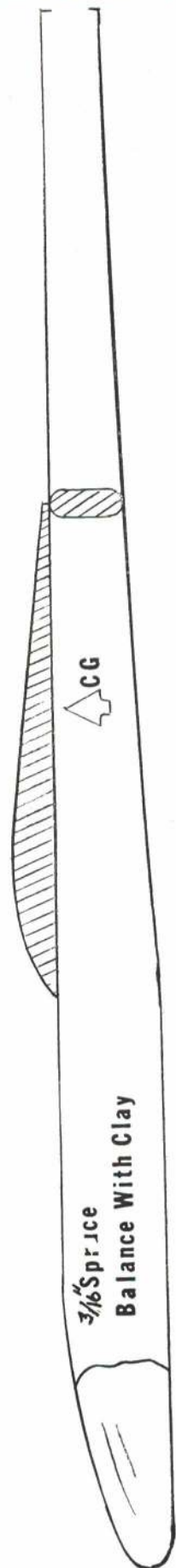
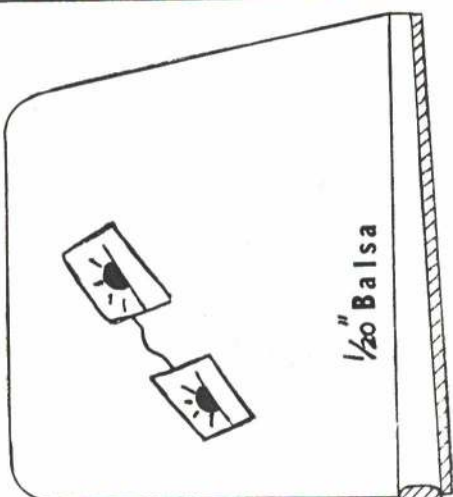

MORE NEW PLANES FROM CMI

SPEEDSTER

Speedster 1/2A
"Goodyear Racer"

- ☆ Light and Flexible
- ☆ Fast Construction
- ☆ Full Size Plans
- ☆ Goodyear Racing Rules included
- ☆ Designed by Dean Swift
- ☆ \$3.50



OLD TIMER

Old Timer 1/2A
"Stunt Plane"

- ☆ Designed by Dean Swift
- ☆ 18" wing span
- ☆ Excellent Stunt Trainer
- ☆ Full Size Plans
- ☆ Under Cambered Airfoil
- ☆ AMA Stunt Pattern included
- ☆ \$3.95



RC Guillotine
15 to 23 engines
Kit R103 - \$10.95
(Kit only)



UC 1/4A Guillotine
.049 to .09 engines
Kit C102 - \$3.50
(Kit only)



COMBAT V
UC Guillotine
for 35 engines
\$6.50 (Kit only)
Winner of
8 trophies at the
Nats - Kit C101

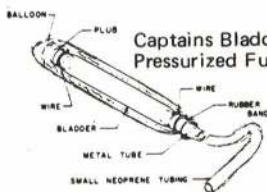

Captains Bladder
Pressurized Fuel Tank 59¢



QUALITY
AIRPLANE KITS

P.O. Box 79 Des Moines, Iowa 50301



The SST

This kit was featured in American Aircraft Modeler Tenderfoot series. This is a very stable easy to fly plane. The kit includes tricycle landing gear for realistic take-offs and landings and Military decals.

AT LAST.

A TWIN THAT'S EVERYTHING A TWIN IS SUPPOSED TO BE.



The Northfield-Ross 60-Twin: Compact. Lightweight. Powerful.

And—most important of all—so vibration-free that it cannot possibly cause radio failure.

It's the first twin-cylinder engine that actually performs the way a twin-cylinder engine *should* perform.

In fact, it's everything you expect a twin to be (only no other twin is) because it was designed by Lou Ross and is manufactured by a company that's famous for high precision manufacturing.

And, incidentally, the Northfield-Ross 60-Twin has two big relatives that will give you even more vibration-free power: the Rosspower 4 cylinder (1.2 cu. in.) and the Rosspower 6 cylinder (1.8 cu. in.).

We'll be happy to send you complete information and a free brochure about all three Northfield-Ross engines.

Just write to Northfield Precision Instrument Corporation, 4400 Austin Blvd., Island Park, N.Y. 11558. Tel.: (516) 431-1112.



NORTHFIELD
PRECISION INSTRUMENT CORPORATION

Where the Action is

Control Line

BILL BOSS

SPORT AND SCALE

The Smithsonian Calls: One of the highest honors a scale modeler can hope to achieve in our country has been accorded William (Bill) F. Harney (Wakefield, Mass.). The honor I speak of is a request by the Smithsonian Institution, Washington, D.C. for a scale model of his to be put on permanent display. The object of the Smithsonian request is Bill's excellently executed B-25.



Above: Bill Harney displays scale B-25 bomber he is donating to the Smithsonian in front of MIT Lincoln Lab where he works. Below: Nick Bdera of Bayside Wiretappers M.A.C. shows his profile Carrier ship and third place trophy won at recent LIAMAC meet in New York.

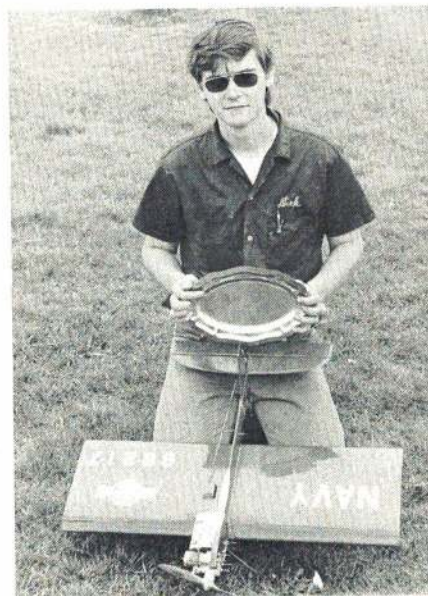

In early 1972 Harney sent a letter to the Smithsonian requesting information on a Japanese Zero which he is building for 1973 competition. In order to show that he is an earnest modeler and had real need for the requested information he sent along a photo of his B-25. In addition to receiving the info on the Zero, he received the request for his B-25. It seems that the Smithsonian did not have any representation of the B-25 in its huge collection of Technological memorabilia. So, on August 15, 1972 Bill Harney turned over his B-25 to the Smithsonian.

For those of you who have never had the pleasure of seeing Bill's B-25 let me give you a brief description. The plane has a metal skin that was hammered out of multilith printing plates. A complete rivet pattern was simulated by hand punching the metal panels. Instrument panels was complete with all dials, switches and an internal lighting system. All access hatches, and canopy windows, as well as flaps, ailerons and rudder trim tabs that are fully operable. Several hundred photos were collected to substantiate all the models details which included all gun and engine burn marks as well as body dents and even the crews footprints on the wings surfaces.

Bill's 45 1/2" span bomber won many regional meets from 1962 until 1969 when he placed second in the Nationals earning himself a position on the 1970 World Champion Team. The B-25 was too heavy for World competition so Bill built a Folke-Wulf which placed third in the World Competition.

The story of Bill's modeling success would be great for just having attained a winning position in World Competition, but then to be honored by having a model immortalized at the Smithsonian can only be the greatest—Congratulations to Bill Harney a great modeler, for a great model and a great honor.

World Championships: I would like to take this opportunity to say "Congratulations" and "Thanks" to all of the U.S. Control Line competitors that competed in the 1972 World Championships held in Helsinki, Finland and Toulouse, France. While individuals did not sweep many of the events as they have in the past, the U.S. teams for most part did very well.

Helpful Hints: To prevent fuel and oil seepage into engine mounting holes in wooden engine bearers Milton Jowers provides the following suggestion. When drilling engine mounting bolt holes make them about 1/16" larger than is required for bolt clearance. Now cut four pieces of medium sized fuel tubing (Clear Plastic type) to the width of the motor mounts, and insert one in each of the mounting bolt holes. When the engine is to be installed screw the bolts through the tubing and into the nuts on the other side of the motor mounts. The plastic tubing provides a seal between the wood and the screw threads preventing fuel oils from getting to the bare wood inside the holes thereby prolonging the life of the engine mounts.

New Club: This month we have the pleasure of welcoming the Bayside Wiretappers M.A.C. (New York City) into the modeling fraternity. The club formed only a few months ago started out with about six members and are now boasting near twenty. The club members are generally in their teens and early twenties, and have become a red hot group in local competitive circles. Their interests run the gamut of CL events, Combat, Carrier, Dive Bombing, Stunt and Rat Racing, and are providing themselves worthy opponents by picking up many trophies in local contests much to the chagrin of many of the previously steady winners. The only events these guys have missed are Speed and Scale, but wait until next year.

Besides becoming an AMA chartered club they have joined the N.Y. Assoc. of M.A.C. and already getting into contest work by helping out at the Association's 1972 12th Annual Meet. A great group of guys, with plenty of enthusiasm for our modeling sport. Good Luck to you all, and welcome to the group.

JOHN SMITH SPEED AND RACING

FAI Semi-Finals: Held in Cleveland over Labor Day weekend, we had nine team race



Smith and Sargent working.

Smith and Sargent playing.



teams and three speedy types show up. Since we were to qualify nine teams or fliers in each event everybody went home a winner (?). Team race times ran from a 5:11 to a 10:31! The Speed guys ran from 17.6 to 23.32. Needless to say, we had no world beaters present. With rain and low temperatures the TR engines failed to cooperate, many running too cold to have a basis for needle settings and compression adjustments. Even though some past world team members flew, some kids and old men beat them. Informality was the order of the day as the idea was to let every body get in flights. We did run a 200 lap "feature" at the end of the festivities. I think one team may still be out there trying to get enough laps to finish. Let's hope by next Labor Day when the team finals are held, everybody will be better prepared, speeds will be up, pit times down and someone can break the four minute mark. It looks like that will be the number to hit if we ever hope to beat the team from USSR.

I Flew with The Blue Angels or CL Fliers Do Have More Fun: The Blue Angel RC Team was in Cleveland during the FAI meet so they could participate in the National Air Show in Cleveland. During practice they rekkited a Bear Cat on the runway. So Ed Sweeney drafted me to do the repair work on Saturday night. At 4:30 Sunday morning we mopped on the paint. These guys may draw the biggest crowds and rightly so, for they put on a great show, but believe me, we still have more fun.

New Products: Space Age Fuels, Kewanee, Ill. 61443, makers of NitroTane fuels. Available with nitro contents from 5% to 75%. Samples tried gave 6 to 7 mph increase in 049s over other available fuels. (60%) Try it, you'll like it. Kirn Kraft has new 1/2A speed tops available. Fits Cox pan. Beautiful workmanship on these Epoxy-Fiberglass shells. Lightweight too. Write to 283 N. Spruce Dr., Anaheim, Calif. 92805. Ask for '73 price list.

3 in 1 Brand: How many of you Juniors know you can build one airplane and fly three Speed events with it? By using a profile proto B airplane, 125 sq. in. wing, you can fly Proto, B Speed and by changing engines fly in .40 class Junior C Speed. You won't set any big national records in B Speed or C Speed but you will be very competitive in all but the larger AAA Meets. Check your AMA Rule book for the Proto requirements.

Fastest Rat in the East: Also North, South and West. Bill Keller, Dayton, Ohio, really turned it on at the Junior Air Races in Cleveland, August 19-20. His Boss Rat turned 4:39.2 for the 140 lap run. Bill won the Nats

with a 5:10.4. For all you non-believers there were two watches and two counters on the model. Top end was 11.9, (151.20 mph). HP .40 for go power, and two pits on the best ever run at a AAA Meet.

JOHN BLUM

CARRIER AND STUNT

Carrier Landings: Theoretically there may be no maximum score in Carrier. The final flight score is influenced by the ultimate performance of the aircraft in the speed runs, since the maximum scale and landing points are fixed. The record for the event is now over 600 points and each season keeps climbing. The scale points are easy to obtain; the speed runs are dependent on many factors both commercial and talent; but the landing points are a factor of practice. Too many excellent flights have been scratched due to an incomplete landing in both local and National competition and this is entirely an element of practice. When the point spread is close, the landing is too important to leave to chance. How many modelers practice with a deck before entering competition?

The sketch shows a practical approach to a practice deck that is quite useful. The theory is to practice with four arresting cables. If you can make consistent landings in practice with four cables, then a ten-cable deck in competition will be easy.

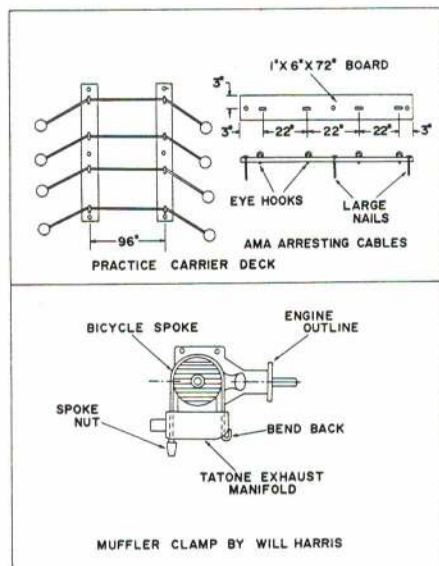

The setup is made from two six-ft. long standard 1 x 6" boards common to any lumber supply firm. Spaced evenly along the center of the board are four eye-bolts. The 1/4" diam. threaded portion must be cut off after installation. The local hardware store can supply the long nails. Use the long, approximately ten inches, aluminum type which are designed for house guttering installation.

The boards with the eye-bolts can be spaced on eight-ft. centers, centering with the flight path, and held in place with the long nails. The four arresting cables, per AMA specs, can then be installed and you have a good practice deck.

Profile Carrier model by Bert Allaire of Jersey City. McCoy 35. Note antenna wire, auto rudder, bombs and pilots.



Muffler Bracket: Via the San Jose (Calif.) Aero Modelers Newsletter, Will Harris presents an effective muffler clamp. It shows adaption to the Tatone exhaust manifold, but has other uses. A typical bicycle spoke is inserted thru the drilled holes in the manifold to form a "U" shape. Then the unthreaded end is cut to length and bent to form a hook. The nut is tightened and a reliable clamp is created.

Throttling Questions: The most effective approach to throttle operation is the three-line system. Using a Robert's three-line throttle bellcrank is the easiest to obtain, install and operate. However, the urge of the competitor for several more points, or the curiosity of the experimenter, has brought about the two-line and one line systems. Primarily, the two-line arrangement is that of the basic UC system; and the one-liner is the monoline system. However, for throttle, each necessitates the incorporation of an auxiliary throttle actuating system that can be manipulated by the control system. This may be electrical or mechanical. A lot has been tried with both approaches, with most effort on the mechanical side.

The basic difficulty is pre-loading (pre-setting) the throttle so that the ultimate high and low speed run can be achieved during the same flight. The ability to compensate for the needle or throttle setting from the handle is negative with other than the three-line system. So, that's where the problem begins and we can start discussion there in the future.

Free Flight

BOB MEUSER
SPORT

The Cordless Electric Model Airplane: The first electric cell was constructed within a century of the birth of Christ. A flying model aircraft was exhibited in France in 1784. Polystyrene plastic was developed in 1828. The first electric motor turned in 1833. Mattel put it all together in 1972.

The Mattel Super Star looks and flies like a well-tempered scale model, and virtually flies right out of the box. The nickel-cadmium battery, charged from a 6-volt lantern battery, or from a car battery, powers it for flights of a minute or two. Mattel is not the first, of course; a battery-powered model flew in the early 1950s, and three commercial systems appeared in the early 1960s. Three electric power plants for model planes appeared on the market in 1972. But Mattel showed that it doesn't have to be sophisticated, complicated, or expensive. Free Flyers, who get their

Peter Allnutt, Toronto, Canada launches the Blimp—McGillivray design. The rudder motor weighs 50% more than rest of model.

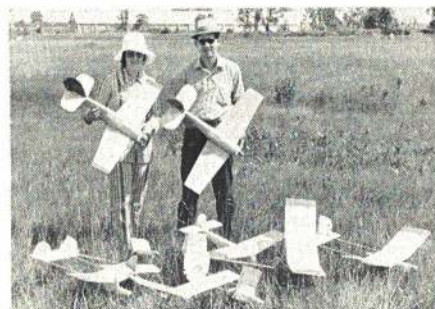

David and Carol Kruse, Minneapolis. Models are stick-and-tissue and foam. Free-flight duration model uses 50 cent Mabuchi RE56 motor from Radio Shack.



kicks from seeing the product of their own hand and mind in flight, might be temporarily amused by a store-bought toy that can duplicate so well their own best efforts, but will be quick to adapt the Mattel power plant, or similar home-brew systems, to their own sport and scale creations; the Flightmasters have already included an electric-power event on the bill-of-fare for their 23rd Annual Scale Model Contest.

It is a wonder that more hasn't been done with electric power since a little figuring shows that the best batteries now on the market put out over 100 times as much energy for their weight as the finest vintage Chateau Pirelli, 1959—which quite possibly accounts for the fact that you don't see many rubber-band-powered flashlights around.

Whether the tremendous potential of electric power will have an impact on competition non-scale Free Flight remains to be seen. We have great hopes.

I would be delighted to hear from any of you who have any ideas or information about electric propulsion. Tom Swift lives!

Sympo 73; Call for Papers: Tom Hutchinson, 880A Magnolia Ave., Pasadena, CA 91106, is the man to contact if you might have a paper for the Sixth Annual Symposium of the National Free-Flight Society. Deadline is April 1 for completed papers, but Hutch should know by February 1 if you intend to submit one. Suggestions for candidates for Model of the Year Awards also may be sent to him, and should be submitted by early in January. Hutch's highly successful model designs have appeared in the magazines and in kit form, he has served many years as an administrator and as a newsletter editor, he is himself a Sympo author, and he is a bear for work. We'll look forward to another great Symposium report.

Ugliness Is Only Tissue Deep: Unlimited Rubber models are seldom handsome, but Jack McGillivray's aptly-named Blimp must be the ugliest of all. The fuselage is too fat, the wing, stab, and rudder look as though they belong to three different airplanes, and the two halves of the rudder appear to have been installed by different crews. But closer examination reveals that every stick and joint has been thought about, each piece is sized and positioned to adequately but barely do its job, and no wood is carried aloft just for the ride. The nose-"block" is not a block at all, but a carefully contrived assemblage of two dozen

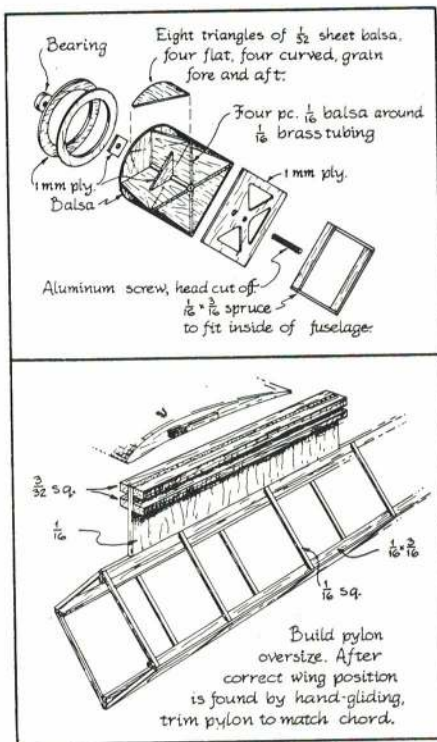

WALT MOONEY

SCALE

Contest Roundup: Bob Clemens' son Chris has won the Junior Peanut scale event at the Nationals for the last two years with an excellent model of the Farman "Mosquito." He is shown here with his model and his latest trophy. The trophy with its little Peanut man is a really great addition to any trophy case.



Chris Clemens and Farman Mosquito.

pieces of plywood, balsa, and metal. The wing halves plug into the slim pylon, but the joint is not subjected to bending forces; the lift is taken by a pair of nylon cords running from the spar to the bottom of the fuselage. A rubber band over a hood on the top of each wing holds the wings up while the model is being handled—the lift keeps them up when the model is in flight—but if the model goes belly-up upon landing, the spar doesn't break, the wing halves fold harmlessly. Rectangular longerons laid on the diagonals withstand crushing far better than square ones of equal weight. Fuselage uprights are only 1/16 in. square. There are no diagonals in the fuselage forward of the wing because there is no rubber torque there. The result is an airframe that can carry half again its own weight of rubber, yet one that is rugged enough for the rigors of competition. For madmen only; not for everyone . . .

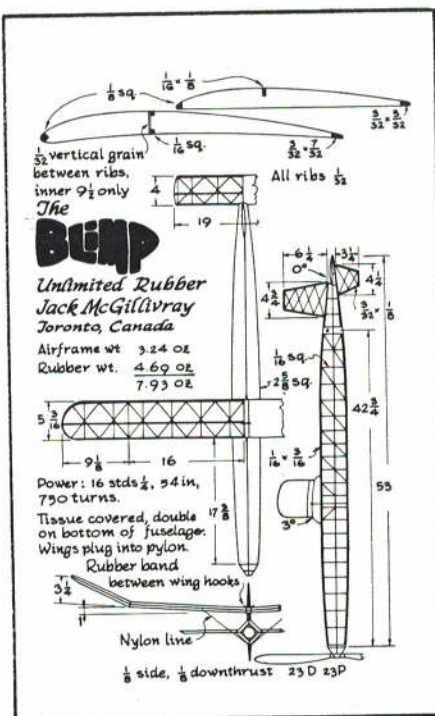

D. Osborne's Curtiss Fledgling has 39" span.



Way up north in Canada, Dennis Osbourne suffers through about six months of winter, or at least so he complains, but at least that gives him lots of time to plan and build. His rubber-powered Curtiss Fledgling posed here in the winter snow has a wingspan of 39 in. Its truly a great effort, and we hope it flies as well as it looks next summer.

The Williams brothers have come up with a new spinner called the Mark II. Its available in eight sizes from 1 1/2 to 3 1/2 in. diameter. It has no external screws or holes and can be used with electric starters.

Granger Williams took first place in the RC seaplane event at the August Flightmasters seaplane contest with his Deperdussin racer. It has wingwarping for lateral control and flies really well. Tsirgi's little (that is the real plane was little) Brandenburg was second. Of note is the fact that both these models are flying really well though their first flights at previous contests were far from perfect and

Granger Williams and "Dep" racer.



were saved by the excellent piloting of their builders. Granger's model appeared to be quite tall heavy on its first flight which is not too surprising considering the short nose of the "Dep." The Brandenburg had an aileron come loose but was brought down safely. It just goes to show that if the model gets past its initial tests, it can do really well in subsequent contests. Still most of us bring untested models to the scale contests, often they are even unfinished. Still its more fun to have a model entered and not win than it is to be a mere spectator.

Fulton Hungerford traveled all the way from Florida to fly in the Flightmasters scale speed contest and the scale seaplane contest. He flew a magnificent Loening amphibian in both events and took third in the speed event and first in the Rubber powered seaplane event. Fulton is the guy that manufactures those great spoked wheels in so many handy sizes.

As your scale F.F. correspondent I missed both the Speed contest and the Seaplane contest and its outdoor picnic that followed at Fernando Ramos' spread. I didn't really want to miss either one, but the following which is copied from Fudo Takagi's article "In and Out" in the San Diego Orbiters' September newsletter explains what happened.

"How does one miss two gala scale meets on successive weekends? It's easy if you are also an avid full scale glider pilot, and a regional 1-26 glider meet falls on the week between the scale speed and Flightmasters Scale R.O.W.

"Knowing that you are going to miss the scale speed meet, you arrange to have your models proxed. You are pretty sure you'll be back for the Hydro meet on Sunday. That's when the best laid plans go astray. You find that the distance event is on Saturday the day before the Hydro event. There you are soaring around late in the afternoon, when you find your last big thermal and you are headed East towards Las Vegas.

"Meanwhile unbeknownst to you, your ground crew (wife, Carole, and kids) has problems with the trailer near Barstow and has to stop for repairs. Weak batteries in your radio, due to a conked out charger, compounds your communication woes. Here it is, after eight pm, getting darker by the minute as you head northeast past Las Vegas. Finally with Las Vegas 20 miles behind, you set down in the center of Dry Lake, Nevada, rather than risk damages and possible injuries though you still have enough altitude for ten more miles of flying. (Well it was dark, and that was the last completely unobstructed landing place I knew of.)

"It's a 2 1/2 mile walk out from the center of the lake to the highway and then a long walk back to Las Vegas and a phone. Nobody picks up hitchhikers at night in the Nevada desert. But wait!!! your luck changes. Here comes a car towing a glider trailer. You wave, holler, jump up and down, and get a lift into town. The rest is anticlimatic as you call and find out where to contact your crew; wait, nursing an iced tea in an all night restaurant (what else when you are a teatotaler?).

Flash back to the scale speed meet. Your R.E.P. racer doesn't get qualified as it gets clobbered trying. What can you expect from a proxy that wins the best crash prize flying in the non-scale event.

"What happened at the Scale Hydro picnic? Don't ask me! I was waiting for Walt Mooney to show up (from Las Vegas)." So goes Fudo's write up.

Needless to say I was still at Dry Lake the Sunday morning of the Flightmaster's Scale Hydro meet and missed the picnic that was enjoyed by all who attended it. This was the third year that this contest and picnic was sponsored by the North American Rockwell Flightmasters. It's a truly enjoyable way to spend a Sunday. The competition is stiff, but the comradery is the best you'll find in this life.

BOB STALICK

RUBBER, GLIDER AND POWER

Caddo Mills FAI Finals One More Time: Gadgets and other equipment are "in" for power models. The most popular piece of equipment is the Auto-Stab/Auto Rudder, usually connected to a Seelig timer.

Important in any gadget operation is simple, foolproof functioning. This includes initial installation, ease of field adjustment and operation, and repair and replacement. Let's take these items one at a time and recommend means of dealing with them.

Initial Installation: Design the system so that it has a minimum of moving parts to get the job done. Starting with the timer, mark the arms or position the lines so that they can be hooked up only one way each time—to avoid the embarrassment of having the wrong thing happen at the right time. Next, use lines that won't shrink, stretch or bind, such as stranded UC cable of around .012 to .018 diameter. Use a small diameter spring or, if necessary, rubber bands to provide the necessary tension. Then, run the lines through guides to the fuselage rear—Gold 'N Rods work fine here—this keeps the lines from tangling and allows easier replacement should that need arise. Whenever the lines make a sharp bend, provide a non-binding bearing surface for them to go around, a nickle plated brass tube is suggested. The Auto-Stab arms themselves should be mounted on a similar non-binding pivot and spring loaded (using a safety pin type spring) so that they always pop out of the way of the stab. These arms must be adjustable via some sort of screw adjustment system. This system can be mounted in the arm itself or, better, out of the way in the fuselage. The purpose here is to allow minute adjustments easily to compensate for changes in trim. The whole system should be firmly mounted in or on the fuselage. The stab itself should be constructed to accommodate the auto system. This usually involves something as simple as mounting a metal bearing plate or tube on the top of the trailing edge. In brief, this outlines the installation layout. Referring to the featured sketch should help sort out some more details.

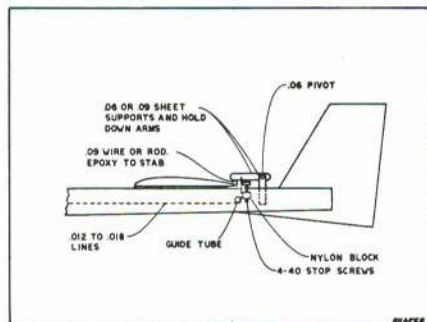

Ease of Field Adjustment: Set screws used in the Auto-Stab and Auto-Rudder set up are necessary for precise and simple field resetting. These must be mounted so that they do not vibrate out of their settings, so tapping nylon blocks for metal screws or using Loctite on metal to metal setups is desirable. On the other end—at the timer—minute bends can be made to give an extra bit more or less time delay, but if more is needed take along a small wrench to fit that tiny Seelig timer nut.

Repair and Replacement: If properly designed and maintained, no replacement should be necessary, but there are times . . . Use of Gold 'N Rods simplifies running a new line to replace a broken or kinked old one. Leaving out the top of the fuselage under the stab mount will allow you to inspect the operation end of the Auto-Stab mechanism to check for wear and tear, and it also allows for ease of replacement.

The best system, of course, is only as good as its operator, so practice using a setup until you can duplicate its operation without error. When the final system evolves, try to standardize it on all your models, so that each one operates the same. That keeps you from using model No. one's technique on No. two and "dorking it" because the setup is different.

Lastly, the best preparation is to have several trimmed models so that if one suffers mechanical failure, repairs can be made in the workshop and not under the stress of contest conditions. Just like the Boy Scouts, "Be Prepared" is more than a good motto.

Next month we'll cover trimming techniques for auto-equipped models.

BUD TENNY INDOOR

Model Weighing: Indoor modelers have cause to be interested in the weight of their models for one of two reasons: to insure that the model meets the rules (FAI Indoor models must weigh one gram, and PennyPlane models must weigh the same as a new copper penny); or to compare new models against the last ones to see if the weight is less. By keeping careful records, it is possible to learn to build lighter models as one gains experience. To check model weights against the rules, a simple go-no-go balance (Fig. 1) works very well. Calibrate the beam with a one gram weight or a new penny hanging on the wire hooks, then hang the model (by the prop) on the hooks. If the model is heavy enough, the beam will dip toward the model.

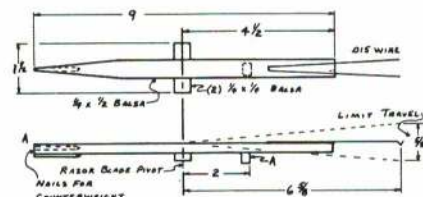

FIG. 1

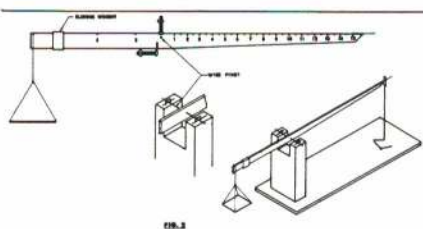

FIG. 2

Beam Balance: For those fliers who want to check model weights as they build, a sensitive beam balance (Fig. 2) is ideal for the workshop. This type of balance is easy to build and can be very sensitive. The accuracy will depend exactly on how well it is constructed, and how accurately the weights are calibrated. The beam is pivoted on a music wire shaft which rests on music wire tracks. The wire shaft is roughly located by brads which keep the beam from falling off the stand, while the long end of the beam is restrained by a wire loop around the pointer.

Beam Construction: The beam needs to be just over 25 in. long, with the shaft located just over ten in. from one end. Build the beam from 3/32 by 3/8 in. spruce or pine, and use dividers set to one in. spacing to mark all the beam calibration points exactly. Be sure to start exactly at the center of the pivot shaft so that any mark is exactly the specified distance from the pivot. Note that check stations are located at two and five in. to the left of the pivot, while the pan hangs exactly ten in. from the pivot. Cut a small, narrow notch at each calibration point on both sides of the beam so that weights can be located at the same place each time. Finally, epoxy two 4-40 screws in place as shown on the beam, and waterproof the beam with three coats of dope. Build the base from balsa block and 1/4 by 3 in. sheet, mount the pointer "cage" and secure the beam in place. Build the pan from 1/32 in. plywood, wire hook and thread.

Beam Calibration: With the balance assembled, two types of balancing are needed. First, make a sliding weight for the left end, using thin lead sheet trimmed to the proper weight to approximately balance the beam level so the pointer is centered in the cage. Screw the nut on the horizontal bolt for exact balance. Next, screw the nut on the vertical screw up as far as possible. The beam should become unstable—that is, it should not hold level but will instead drop one end or the other. Add weight to the nut if necessary to attain the unstable condition! Finally, screw the nut down until the beam just will hold level, then spot-glue the nut in place. This makes the beam very sensitive so that small weights can be measured. Next month we will make weights to use with the balance, and find out how to use it properly.

Radio Control

In Memory of Jim Kirklind: Many kind thoughts and eloquent words will be said over the untimely passing of Jim Kirklind. Here, truly, was a pioneer, a leader, and a champion through and through. A rare and gifted person indeed with an unequalled ability to accept change and promote it as well. Who else but Jim has given so well of his time and efforts over the years in all aspects of the sport? Well known as the master designer, innovator, and electrician as well, not to mention his eagerness to perfect new methods of construction and try new materials: Plastics, foam, fiberglass, what have you.

Always the perfectionist, never entirely satisfied, full of surprises. Really ahead of all of us most of the time. Yet, Jim had a real stabilizing influence in the sport both on the contest field, at the drawing board, and his long hours of volunteer A.M.A. work for that matter.

Who amongst us hasn't benefitted in some way, then, from Jim's influence over the years? As an admirer, as a friend, as a competitor, perhaps by flying one of Jim's designs, or reading one of his construction articles.

Perhaps Jim's greatest ability—the stuff from which champions are truly made—was that wonderful, indescribable thing that made him bounce right back to the top after some resounding defeat. Reflecting back on that illustrious contest career, one might say Jim had that certain something extra. Maybe you can't define it, but its absence is going to be felt.—George Hill.

DON LOWE

SPORT AND PATTERN

NATS Reflections: The '72 NATS is now history and will be remembered with fond thoughts by some (the winners), bitterness by others (losers) and skepticism by others who feel that some operational improvements are in order. Personally I feel that a pretty darn good job was done considering the extreme handicap of not having the Navy's help. It is apparent though that some improvement must be considered based on personal observations and a sampling of opinions of others in attendance, both as competitors and as officials.

Most NATS Class A and B fliers that I have talked with were bitter due to "second class citizen" treatment. They cite the simple



Above: Project "Teleplane" aircraft, developed by Air Force at WPAFB for remote piloting experiments via television. Below: Seen at Minnesota State Stunt Championships, Bob Swenson and original design of a butterfly tail Pattern ship. Placed third in Class C.





Bob Violett, pilot half of famous Telford/Violett racing team proves he flies Pattern ships, too. His new design with flying stab seen at Dahlgren.

fact that they paid the same entry fee as others but were given a half day to fly and only three flights. Even then they were caught up in the facility teardown process Sunday; also, most fliers and spectators had departed for home or the upcoming flight demos. Their award presentation was especially bad with a few die-hards (mostly winners) clustered around the remnants of the dismembered facilities. I can't help but agree that Class A and B fliers deserve as good treatment as any other RC/freeflight/U-control competition category. Why not fly theirs right along with class C/D as is always done at other contests around the country? What say you out there in radio land?

Commonplace Stuff: Most of us who have been in this hobby for a while take for granted a lot of the little goodies and techniques that we feel everyone must know about. But what of the newcomer who often must go through trial by fire (crash?) to learn some of these simple facts. I know that I have difficulty relating at times to the newcomer's problems since its all pretty much "old hat" to me. How about the simple technique of using muffler pressure to pressurize your fuel tank? This, for those who have tried it, goes a long way toward solving the engine "leaning out" that occurs during flight as the fuel tank is emptied. Did you know, however, that the amount of pressure available by this technique is variable as a function of where you hook onto the muffler? I recently was flying a "Pookey" test air plane equipped with a ST 40 ABC racing engine and ST flow-through muffler. Now we all know that crankcase pressure is required to feed a racing engine—Right? Wrong! Being a lazy type I first hooked the pressure line to the normal ST muffler pressure tap. This tap senses pressure between the inner and outer muffler shells and is apparently a low pressure region since the engine would run but sag (lean) when "g's" were pulled; so, I then hooked the pressure line to the prime tube—what a difference! This tube is opposite the exhaust stack and "sees" the direct impingement of exhaust gases. The engine is very happy with this arrangement and runs great. So—muffler pressure will help your engine; you may have to experiment a little to find the best place to tap the pressure.

Another technique that I and others use that seems to puzzle some people is placing the receiver antenna inside the fuselage. Now we used to do that all the time back in the reed days—remember? When we got the first fussy proportional sets, antenna placement became very critical so out came the antennas into all kinds of configurations, including vertical whips. Now, I will be the first to admit that a whip antenna or placement outside the model is best—but certainly not necessary for most equipment if care is used in placing the antenna. I simple route the antenna away from other wiring, at least one inch or more away from servos (this is important) and lay it along the top of the fuse as far as possible from wiring, pushrods, and servos. This works just fine for me and makes a neater installation. It will also puzzle your friends who will wonder where the antenna went. A neat arrangement for the antenna, and to make it easy to install and remove, would be to glue in a plastic tube of some sort (not metal!) inside the fuse. Then you simply shove the antenna into the tube being very careful not

to fold it or coil it. Incidentally, when hooking up your antenna do not fold excess antenna back over itself such as some do when fastening to the fin, etc. This effectively shorts out that section of antenna and will reduce range. For those who would like to install the antenna wire permanently in the fuse, this is ok as long as you use a good antenna connector. One such device recently marketed is a gold plated pin connector made by Sukarta Hobbies of New Jersey. They call it "Shove It" and it sells for a buck twenty-nine.

BOB STOCKWELL

PYLON

Internats: With the best intentions, the British nevertheless proved it is possible to have too much organization in a pylon race. At the Internats they had four men on each of the near pylons, creating unbelievable congestion in the one area where there ought to be only fliers and callers. Partly as a consequence of the safety hazard they had thereby created, they put in a new rule outlawing any flying at a height below the 20 ft. pylons—and the main casualty was a zero for Charley Smith, whose flying literally fell apart the second day when he was no longer allowed to fly his normal course: and, I should add, the normal course of about half of the top pylon competitors I know, including three national champions, three NMPRA champions, and exceptionally fine fliers like Wayne Wainwright and Ted White and Bob Francis, who though they have not won the big ones are leading giant-killers at any contest.

The British also had some curious interpretations of rules. They interpret the six-minute rule to mean you have six minutes to complete the race, including allowing a restart if your engine flames out. Larry Leonard, for example, busted a prop on takeoff, ran out and changed props and took off again, finishing with a sparkling 5:15 for that heat: no reflection on Larry, just a reflection on this curious interpretation of the rule. In this country no one has ever interpreted the rule as anything but a device to disqualify guys who can't kill their engines after the race is over. A flame-out, or failure to takeoff at the drop of the flag, is an automatic zero in all American racing.

Another rule whose interpretation caused endless debate and difficulty was the FAI mid-air rule. It's a silly rule, in my candid opinion, but it is clearly intended only to give an opportunity for a plane damaged in mid-air to be landed and checked for safety without penalty: namely, by giving that pilot an opportunity to fly his heat again—but *not necessarily* against the identical competition, which is the way the British interpreted it, reflying identical heats repeatedly.

Jeff Bertken, third at Cranfield Internats, K&B power, PB Products Miss B.S.



Terry Prather and Miss B.S. that bit dust in 12th lap of 1st heat at Cranfield.

Bob Violett and Cliff Telford checking front end of Supertigre on FAI ship.



It was the impression at least of Terry Prather and Whit Stockwell that the British also proved, even though they didn't take the top trophy, that the H.P. is the best FAI engine (for 1972-1973 will see other possibilities, with the K & B production Schnuerle available to experiment with on alcohol). Even the superlatively good SuperTigres of Terry Prather and Cliff Telford were not turning within 500 rpm of the H.P.s at this event, and only the combination of brilliant flying, an exceptionally clean airplane, and a little luck enabled America's top FAI team of Telford and Violett to win against the H.P.s of Phil Greenough, Allen Mann, and other top British competition.

CARL MARONEY

GLIDERS AND FAI

Introducing "T₂": a 75" span all-purpose RC glider for two-channel proportional systems. Designed by an aerodynamicist who is also an active RC flier, with over twenty years of varied modelling experience to reinforce his design ideas. Here is one model which is engineered for ease of building, excellent performance and durability. This ship features a unique control system having coupled ailerons and rudder and coupled flaps and elevator plus moving stabilizer. The manufacturer
(Continued on page 87)

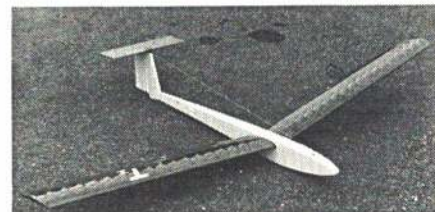

All Balsa T2 kitted by SFM.

The second prototype of SFM Ka-6E, a 100-in., 3½ to 4 lb. slope soarer to be kitted in early 1973.



CLAUDE McCULLOUGH

SCALE

Rules Trial: The Fourth Annual Chicago Scalemaster's Rally, held September third at Glenview NAS, featured a test of a set of regulations drawn up by Dave Platt which were used to operate the AMA RC Scale event instead of the book rules. Last year this all-scale contest tried out the Sport Scale regs which were subsequently adopted as a provisional event and published in the 1972 AMA Rule Book.

Main feature of the proposed regulations used at the Rally are so-called "Equalizer" scores in which points were awarded according to the scale judges assessment of the relative difficulty of the model subject involved. Models of prototypes of great simplicity are given an equalizer score of zero while the most complex are awarded ten, with other types graded in between this range depending upon their classification by the judge. This approach to the much debated question of complexity factor allots approximately ten per cent of the maximum possible scale fidelity score to this category, so is not heavily weighted in favor of highly complex models. The idea seems to be to help make up for some of the flight and construction disadvantages suffered by complicated aircraft. It makes for a very interesting discussion however, to place examples of prototypes on the zero to ten scale, particularly in some of the middle areas.

The flight pattern used features a shortened required list of maneuvers, including a flypast, and adds points for Realism in Flight. The rest of the flight is an open option arrangement in which the flier can demonstrate the qualities of his model with whatever maneuvers or scale operations he wishes to call out rather than select them from a prepared list in the rule book. Points are awarded on degree of difficulty as compared to listed examples.

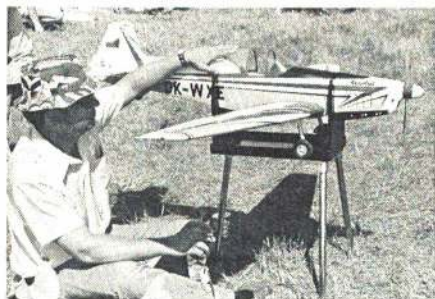

Don Botteron with his Zlin Akrobat at the Nationals.

Gary Owens gave his Hurricane authentic touch of aging, and used markings from Pro-filer on aircraft.



Possibly the most controversial provision is the elimination of separate workmanship points in scale judging, workmanship being held to be part of scale fidelity. This may save a column of addition but many scale builders would want to argue about this one. Several other proposed approaches to new rules for RC Scale are expected to be made before the April cutoff date, so the SCB will have its work cut out for it in drafting the 1974 RC Scale Regulations.

Better Bends: George McKee, Jr. uses a draftsman's flexible curve ruler to aid in the task of laminating strips of balsa or spruce to form curved wing or tail edges, producing a smoother finished product than the usual method of forming against a row of pins. These rules are made by several companies in 18 to 36" lengths and are covered with a plastic coating to which glue (except epoxy) will

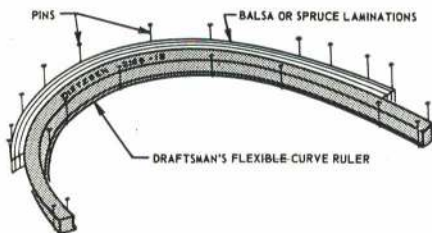

not stick. George has a Dietzgen 2168, 18". Since the ruler has a slightly chamfered edge, small wedges of scrap balsa are necessary behind the first laminate to insure squareness. In addition to the pins to hold the rule in place around a small radius. The rule can be used on the outside of a curve pattern as well when required but he feels that inside works better where the shape permits. Aliphatic resin glues such as Sig Bond or Titebond are best for this application since they work on damp wood and can be sanded.

Special Interest

JOHN BURKAM

HELICOPTERS

From the Editor: During October I had the pleasure of visiting MRC's operation in Edison, New Jersey. The occasion was announcement that MRC would shortly be marketing the Kavan helicopter. Franz Kavan and his pilot, Bruno Gottfried, had come from Germany with two of the helicopters to give live demonstrations. These demonstrations were most impressive. I'd like to tell you about the model and its flying abilities as an interested observer.

The model is of a Bell Jet Ranger powered by a 60 model aircraft engine. The helicopter is the only model flying which uses the Bell rotor head configuration of gyro with cyclic mixing bars to individually control each blade and is the only model design with collective pitch control on the main rotor. A four-channel radio with five servos controls the machine. The throttle function at the transmitter operates both the engine's carburetor and the main rotor collective pitch with two electronically paralleled servos. The first half of the throttle control movement commands the engine speed from idle to full throttle and the second half of the throttle control movement commands the collective pitch control from minus 1 degree to plus 5 degrees. Altitude is completely and easily managed on one function. The rudder control tail rotor collective and pitch and roll are on the other control stick.

While I find it difficult to separate pilot ability from model capability, the Kavan machine was most impressive in flight, too. It is smooth flying and realistic. It seems capable of excellent speed and very easy and precise altitude control. It is only during hovering that some control difficulty is experienced (as with any model helicopter) and varying the main collective required some tail rotor compensation. The model appeared unsteady in yaw during takeoff and landing for this reason. With the mixing bar added this should be

Ed Sweeney's shaft-driven conversion of a Du-Bro Whirlybird.

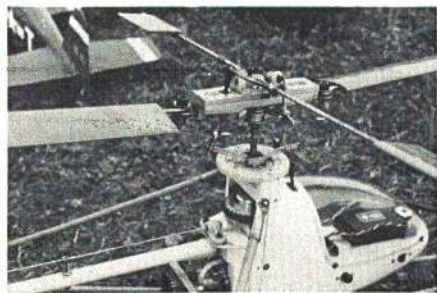

corrected somewhat. Nice thing though is the model's ability to descend for landing without power changes or ballooning. The above-mentioned fault(?) is more than offset by the fact that having a rotor at a steady high rpm means the control quality remains constant throughout descent.

In addition to the uniqueness of the helicopter already described, Kavan has also engineered two other imaginative items. First one is a rate sensing gyro which controls the tail rotor. This gyro keeps the tail steady regardless of power or main rotor collective inputs. The normal rudder function has about a 50 percent authority over its servo for flight control. Thus the pilot is relieved of torque compensation. The second item is a simple mixing bar to couple mechanically the main rotor collective with the tail rotor collective in order to partially compensate for main rotor torque demands with the tail rotor's anti-torque function. Used together, these items could mean that the Kavan helicopter would be flyable just like a fixed wing aircraft and very easy to learn to fly. Furthermore, the gyro device could be used on the roll and pitch controls in addition to the yaw axis for semi-automatic flight control. Neat.

The MRC-Kavan helicopter (without the gyros at first) should be available from MRC during the first months of 1973 or maybe sooner. It is typical of Kavan's other products—extremely good mechanical design and fabrication. The helicopter will be the most expensive RC chopper at \$400-500 range but is worth the price in terms of product quality. It is also highly prefabricated. Also typical of Kavan products, the model is designed for mass production, like thousands not just hundreds. I'm sure you'll see it again at Toledo—Ed Sweeney.

New England Helicopter Event: August 26 and 27 in Orange, Mass. Every competitor made at least one flight. All but two had crashes also. The 22 prescribed maneuvers served much better than free style flying to show up the measure of control each man had
(Continued on page 78)

Bruno Gottfried, Herr Franz Kavan, and Ed Sclar (of MRC) with the Kavan Jet Ranger.



Wait Schroder about to depart the scene quickly, as Bruno points the helicopter at Wait's camera. Model capable of exceptionally good control and speed.

Bruno has put the transmitter on Herr Kavan to demonstrate the model's excellent in-flight stability. During this sequence the model is not pilot-controlled.





The cars at the 1972 ROAR Nationals in California.

Readers: "Where the Action Is" is your part of AAM each month. The correspondents are experts in their fields, but they need to hear from you. Please keep them well supplied with your ideas, model photos, activities, club news, and newsletters. We pay \$5 for modelers' ideas if used in a column; clubs are given credit.

Have a problem? If it is not too complicated write to a WTAI correspondent. He'll know a useful answer and may even cover the question in his column. Write to the correspondent, c/o AAM, Potomac Aviation Publications, 733 15th St., N.W., Washington, D.C. 20005.

BOB BECKMAN RC CARS

1972 ROAR Nationals: This year's ROAR Nationals at Briggs Cunningham track in Costa Mesa, California, was the largest RC car race ever held, showing that the popularity of this new sport is still increasing. There were 70 entries from all over the U.S., and Ted Longshaw came all the way from England to compete and then take two beautiful trophies home with him. And can you believe that Stig Andersson came all the way from Switzerland just to watch? There were spectators from the Wiki-Wiki RC Car Club in Hawaii. With this kind of interest, possibly next year we could have a truly international event.

Were the races exciting? Well, Dan Gurney stopped by to watch and stayed for three hours sitting on the asphalt watching the oval races. If Dan could have made it the next day for the road races, he undoubtedly would have been there all day. We might just have a new enthusiast starting there. Can you imagine some of the innovations Dan might have for RC cars?

The Nationals this year were split into two driver classifications, Amateur and Expert. The program started off with the Amateur Oval event. Our youngest competitor, 12-year-old Bryan Bowles driving a Thorp car, came in first with Jim Cade (Thorp) second and Dan Amedo (Taurus) third. The victory was especially sweet for Bryan because his older brother, Kevin, also races and usually wins, but this time it was reversed.

The Amateur Road Race event was up next, and there was some real close racing which had the spectators cheering. Bill Vanderziel, driving his Associated car, drove a great race against some strong competition and won this event. Glen Stone was second with his scratch-built car; Glen even built his own engine. Jim Cade brought his Thorp car in third. The overall combined standings (Oval and Road Race) showed Jim Cade as the 1972 Amateur National Champion with Bill Vanderziel second and Don Amedo third.

The experts were up next, and it looked as though there would be some very exciting racing. Every major brand of RC car was well represented with a team of cars. The Marker Machine group, which is currently dominating the racing in the Midwest, was represented by Del Fisher, Bud Schrendli, Dick Dobson and Bob Emmot. Delta was ably represented by Ken Campbell, who came out a week early to practice, and locals Bud Ihnen and Ron Bonnell. Mike Morrissey had a team of three amateurs and three experts with his new Taurus car. Thorp was strongly represented by John Thorp, Gil Gunderson, Dick Sahara and Dick Camp. Jack Garcia and Dick

Norsikian represented Nor/Kar. And the Associated team of Roger Curtis, Gene Husting and Matt Azzara, along with independent Chuck Hallum, were ready.

The Oval event was first on the program. There were three races of six cars each for the 18 car mains. In the final race, Roger Curtis (Associated) did a flawless driving job setting fast time of the day. His ability to maneuver his car to avoid slower cars was a thing of beauty. Dick Sahara (Thorp) followed in second. The overall expert oval times showed Roger Curtis (Associated) 1st, Dick Dobson (Marker) 2nd, Mike Morrissey (Taurus) 3rd.

Road Racing is by far the most popular event in RC car racing, and the next event was the one everyone wanted to win. In the qualifying heats, Chuck Hallum (Associated) set the fastest qualifying time and had to be considered as the man to beat. Chuck has been a consistent threat and just recently broke Gene Husting's track record on the old Cunningham course. In the first main event race the pressure was on. Roger Curtis (Associated) and Dick Dobson (Marker), who finished 1st and 2nd the day before in the Oval race, were up in the first race, but Dobson ran into some early problems and Curtis went on with a smooth driving job to win the race; John Thorp (Thorp) came in second. The next race belonged to Ken Campbell (Delta). Ken showed how he's won so many races in the Midwest with his fantastic driving skill. Joe Swan (Taurus) followed in second.

The final race looked as though it could have been the most exciting with Chuck Hallum (Associated), Mike Morrissey (Taurus) and Gene Husting (Associated) ready to do battle. At the start of the race, Chuck Hallum took off in an early lead with everyone else tangled up in the first turn. After a few laps Morrissey was involved in a crash which broke his antenna mount, putting him out for repairs. Though Husting could pull Hallum about 40 ft. on the straightaway, Hallum was ever increasing his lead. Morrissey got back on the track and duelled with Husting following in second. The overall road race results showed Chuck Hallum (Associated) way out in front, with Roger Curtis (Associated) 2nd and Ken Campbell (Delta) 3rd.

Overall Grand National Champion

Roger Curtis, 1st (Associated); Dick Dobson, 2nd (Marker); Gene Husting, 3rd (Associated).

Amateur National Champion

Jim Cade, 1st (Thorp); Bill Vanderziel, 2nd (Associated-Marker); Don Amedo, 3rd (Taurus).

Servo Protection: Several systems have been devised for protecting the steering servo from the loads imposed, especially in the case of accidents. Most methods have the disadvantage of softening the steering response. Thorp and Delta offer units that provide solid steering up to a predetermined load point, and then give to protect the servo. These units have the added advantage of automatic re-set to the normal position. A homemade version can be produced from easily available materi-

(Continued on page 76)



The most happy fellow—Overall Winner Roger Curtis.

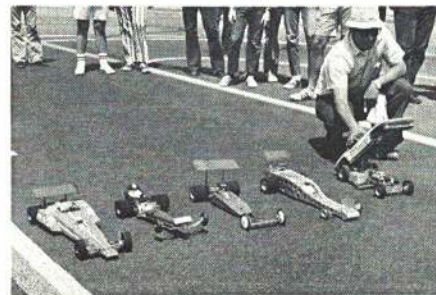

Drag racers range from the purely functional to the very real and scale types. All ran.

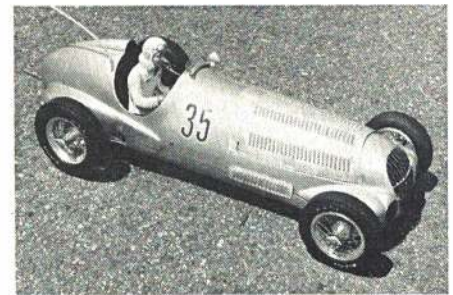

Amateur National Champs on the track prepared just for the Nationals. Looks challenging, doesn't it?

Concourse d'Elegance entrant is an old 1930s machine. Yes, it runs.



 <p>J & J QUARTER MIDGET List \$ 29.95 Special \$ 23.95</p>	 <p>KRAFT KPS-5 SPORTS SERIES List \$299.95 WRITE FOR PRICE</p>	 <p>ALLEN HEAD DRIVER SET A Must for Every Modeler \$9.95</p>	 <p>QUICK FIX in tubes \$2.00 HOBBY POXY Formula II \$3.00 HOBBY POXY Formula I \$1.00</p>	 <p>CLOSE OUT SPECIAL J & N HEAT GUN List \$29.95 Special \$19.50</p>																					
<p>SULLIVAN REALISTIC LANDING GEAR "REALISTIC" LANDING GEAR SYSTEMS LIGHT WEIGHT ALUMINUM</p> <p>GS1 - \$9.95 Spec. \$7.96 GS2 - \$9.95 Spec. \$7.96 GS3 - \$10.95 Spec. \$8.96 GS4 - \$10.95 Spec. \$8.96</p>	 <p>ROM-AIR 3 GEAR Retract System Complete LIST \$100.00 SPECIAL \$79.95</p>	 <p>INDY NEW SPORT FUEL \$5.49 gallon \$3.95 1/2 gallon An excellent Blend for the Sport Flyer!</p>	 <p>WORLD ENGINES BOX FLY List \$29.95 Special \$23.95</p>	 <p>UNIVERSAL SCALE WHEEL</p> <table border="1"> <thead> <tr> <th></th> <th>List</th> <th>Spec.</th> </tr> </thead> <tbody> <tr> <td>2 1/2"</td> <td>\$4.79</td> <td>\$4.31</td> </tr> <tr> <td>2 3/4"</td> <td>4.99</td> <td>4.49</td> </tr> <tr> <td>3"</td> <td>5.19</td> <td>4.67</td> </tr> <tr> <td>3 1/4"</td> <td>5.39</td> <td>4.85</td> </tr> <tr> <td>3 1/2"</td> <td>5.59</td> <td>5.03</td> </tr> <tr> <td>3 3/4"</td> <td>5.79</td> <td>5.21</td> </tr> </tbody> </table>		List	Spec.	2 1/2"	\$4.79	\$4.31	2 3/4"	4.99	4.49	3"	5.19	4.67	3 1/4"	5.39	4.85	3 1/2"	5.59	5.03	3 3/4"	5.79	5.21
	List	Spec.																							
2 1/2"	\$4.79	\$4.31																							
2 3/4"	4.99	4.49																							
3"	5.19	4.67																							
3 1/4"	5.39	4.85																							
3 1/2"	5.59	5.03																							
3 3/4"	5.79	5.21																							
<p>OS 60 GOLDHEAD 72 SERIES List \$59.95 Close Out SPECIAL \$42.00</p>	 <p>WORLD ENGINES BUDDY BOX CORD FOR ALL BLUE MAX SYSTEMS \$4.95</p>	<p>FIELD BOX ASSEMBLED READY TO PAINT List \$24.95 Spec. \$22.95 Kit \$18.98</p>	 <p>OS 2 CHANNEL GUPPY 2 Servos Dry Batteries List \$100.00 Spec. \$87.50</p>	<p>NEW 6-Volt Battery List \$14.95 Spec. \$11.95</p>																					
 <p>Indy P/C SALES (317) 846-0766</p>	<p>BLUE MAX 6 CHANNEL Assembled Complete with 4 S-5 Servos, Charger, Nicads. List \$339.95 INDY SPECIAL \$219.00 We Pay the Postage and give you a Frequency Flag, too!</p>	 <p>VECO 19 MUFFLER \$6.95</p>	<p>NORTH - 10538 Jessup Blvd., Indianapolis, Indiana 46280 • SOUTH - 2747 Brill Road, Indianapolis, Indiana 46225</p> <p>HOW TO ORDER: Send Check or Money Order for prompt delivery. Please include ZIP CODE. Indiana residents add 2% Sales Tax.</p> <p>POSTAGE, HANDLING & INSURANCE \$.00 to \$10.00 \$.75 \$25.01 to \$50.00 \$1.50 \$10.01 to \$25.00 \$1.00 Over \$50.00 \$1.50 Postpaid</p> <p>NEW HOURS: 9:30 A.M. - 9:00 P.M. Mon. - Fri. Sat. 10:00 A.M. - 5:00 P.M.</p>																						

Just one thing has made us the leader.

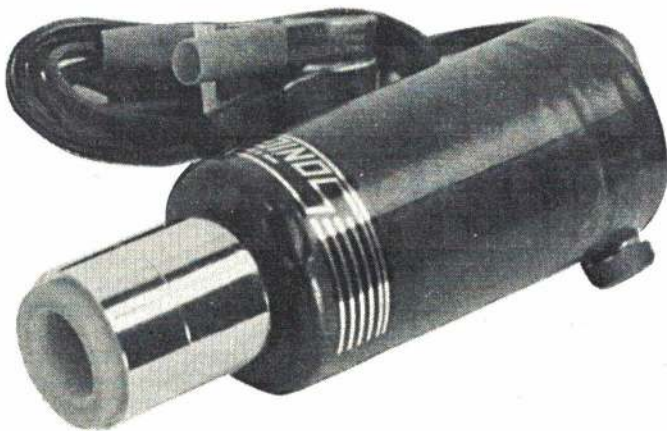

“Performance”

See your local Dealer or write for all the facts on "Nifty" CHALLENGER Electric Starters and MARK II Electric Fuel Pumps.

SONIC-TRONICS INC. 2 South SYLVANIA Ave. PHILA., PENNA. 19111

NORM'S ^{SUPERTIGRE} G.60 POWERED MACH II WINS MASTERS



NORM PAGE WITH HIS MACH II

There were three G.60 Supertigre Blue Heads used in the 32 man "Masters Tournament" at Huntsville, September 72. Their users finished 1st, 5th and 8th. The 5th place contestant was young Steve Ellison of Salem, Oregon. 8th place was captured by Dave Brown who surprised the tool room here at

World Engines in Cincinnati. Norm's engine was an out of the box stock engine that had only been in use less than two weeks before the Masters. We also think it a tribute to our radio control industry that there were no crashes or radio problems reported.

John Maloney



\$59.98
G.60 SUPERTIGRE

We are delighted to quote Norm as saying:

"I doubt if I would have placed first if I hadn't switched to the G.60 Supertigre Blue Head two weeks ago! The power made the difference and the engine runs smoother."

4 MIDWESTERNERS AT HUNTSVILLE



NORM PAGE 1st, DAVE BROWN 8th, JERRY WORTH, ALLEN DUPLER 12th



WORLD ENGINES

8860 ROSSASH AVE.

CINCINNATI, OHIO 45238

720 TURN

(Continued from page 32)

probably need more turn in the climb or flatten climb angle. Transition to right glide turn is normally very good with this ship. The glide should be slow and floating in calmer air. For rough air, trim the glide a little faster. Experimentation will allow you to add just the right amount of clay behind the timer for turbulent air conditions.

I like to keep my glide turns fairly tight. This helps to keep chases a little shorter and also helps the model stay in a thermal. Don't overdo this though, as you could spiral dive in due to the strong lift and circular airflow effect. About a 200 ft. dia. circle is good. Alter stab tilt to achieve this.

One last word on adjustments. Too much DT stabilizer angle will bring the model down too fast. Forty degrees is plenty. A fast DT could result in structural damage or split covering on the wing upper surfaces.

A few flights will convince you. The larger ships are a lot more fun!

Construction

The trip to the hobby shop for the necessary materials should be preceded by a thorough study of the plans. Wood should be selected with an eye towards its final function in the structure. Pick hard, straight grain material for spars and trailing edges. The wing leading edge should be spruce or at least rock-hard balsa. Rib stock should be medium but avoid soft spongy balsa. Try to obtain 48 in. material for the fuselage to avoid splicing. If this is not possible, angle all splice joints and arrange them in the structure in a staggered fashion to avoid any built-in weak areas.

Begin construction with the wing and stabilizer. These components should be completely finished before proceeding with the fuselage to allow maximum curing time.

It is unlikely that you can find 3/4 x 1/4" TE stock, so this will have to be shaped prior to pinning to wing plan. This will be the only "difficult to locate" wood in the model but is necessary to preserve the airfoil. Shape TE with a razor plane or saw to shape on a table saw. Pin down leading edges and spar stock overlapping as shown. The overlapping spar technique produces extremely strong yet light dihedral joints. You'll like it after you've tried it. I install center section bottom planking at this stage. Install all ribs except dihedral ribs and add tips. When dry remove from plan and add dihedral, tips first, then center section dihedral when dry. Add 1/8" dihedral ribs, 1/8" sq. turbulator spars, gussets and upper center section planking.

The stabilizer construction is basically similar. Notch TE for ribs. Be sure space for rudder is correct by using temporary 1/8 sheet spacers. Do not overlook the wire reinforcement at stab leading edge.

Sand the flying surfaces and coat with two coats clear dope prior to covering. The rudder should be fabricated and covered at this point but not instal-

led until the stab is covered and has two coats of dope.

Cover stab with lightweight silkspan. Cover the wing with medium silkspan and double cover center section and center panels. If you have not used double covering before the procedure is simple. Cover and dope wing in usual manner with at least two coats of clear. Apply second layer of silkspan with grain at right angles to first layer (first layer should be spanwise). Attach at edges only and shrink with water. When dry proceed to dope with thinned dope to achieve bond between covering. This procedure results in a very rough yet light covering. Of course MonoKote or Solarfilm would be fine if you elect to use them.

After doping is completed to your satisfaction, allow to cure two or three days and then steam in the warps called for in the section on flying and allow flying surfaces to cure while fuselage construction proceeds. Check the surfaces periodically to make sure curing is progressing without changes in alignment.

Cut out all fuselage parts and glue up pylon and wing rest prior to shaping. Lay out top fuselage sheeting on plan. Add top longerons, formers, fuselage sides, and bottom longerons. Check frequently for proper alignment. The original ship had the landing gear sandwiched between F1 and F2; however, I would recommend the Tatone free flight mount with landing skid attached. When dry, remove the fuselage assembly from the plan and install pylon and 1/16" plywood timer doubler. Modify a No. 6 Rectank as shown and install on right side of fuselage. Drill firewall former F1 and F2 for engine mount and install blind mounting nuts. Install fuselage bottom. Complete wing rest and stabilizer platforms.

When thoroughly dry, sand corners round as shown on cross sectional view and thoroughly sand entire structure. Brush on two coats of clear dope and cover fuselage with lightweight silkspan. Cover forward section from rear of pylon forward to firewall with lightweight fiberglass cloth. Add dethermalizer hardware and finish fuselage as desired.

Band on stabilizer and check alignment of rudder with pylon using a taut thread. If not in perfect alignment, adjust stab key width and/or slots in fuselage to attain perfect alignment. Band on wing and check distance from tip leading edges to leading edge of rudder at its base. Install half dowel keys to bottom of wing to insure alignment. Install engine, timer, prop, etc. as ready for flight and correct CG to point shown on plan. Give everything a final check and you're ready for testing!

Remember, the big ships are more fun!

FLITE BOXES BY INKY

AT LAST A GOOD SIZED ECONOMICAL BOX FOR RC-CL-FF

APPROX. SIZE 8 x 12 x 20

LIGHT AND STURDY—30 MIN. ASSEMBLY

PARTS MACHINED—READY TO ASSEMBLE

KIT ONLY \$7.95 POSTPAID

SEND STAMPED SELF-ADDRESSED ENVELOPE FOR BROCHURES ON OTHER MODELS

SEND CHECK OR M.D. TO

INKY

10436 W. Rip Ave. Milwaukee, Wisconsin 53225



MODEL 50

NEW PILOT ARTF'S



This sharp looking aircraft is designed to fly on elevator, rudder, and motor. It is a relatively large 3 channel airplane, 52 1/2" span. The manufacturer recommends a 20 but would probably fly on a 35 O.K. Nice vacuum formed fuselage, balsa elevator, molded foam wing with solid dihedral brace. Model also includes steerable nosewheel. A little larger than the Pilot Cherokee and Olympia. Worth the additional \$5.00.



This model features the same type of vacuum formed fuselage and foam wing construction used in the popular Pilot Cavalier. The wing span 49.6". Length 39.37" (1 meter). Wing area 461 sq. in. Engine 4 cu. in. Weight approximately 5 lbs. This almost ready to fly pylon racer with racing lines, wheel pants, should make active pylon racing possible for the modeler too busy to build. This is particularly important in this rugged event.



The Phantom is an almost ready to fly U/Control model constructed of vacuum ABS plastic and wood. A very striking looking sidewinder. Wing span 25". Length 25". Wing area 192 Sq. in. Recommended engine 15 to 19. Flying weight approximately 1.35 lbs. Here is a chance for some U/Control flyers to enjoy the advantages of an A.R.F. package.



This is a U/Control combat trainer for a 20 engine. Wing span 30". It is a composite wood and vacuum formed aircraft. Even the name is a ringer.



This glider is the Pilot Thermal's little brother. Foam wings. Vacuum formed fuselage with a plywood od. Manufacturer recommends an .06 engine. .049 engine would probably work well.

SERVICE EXPERTS

ARIZONA

R/C Engineering
P.O. Box 1451
Scottsdale, Ariz. 85252
Phone 602-949-5700

CALIFORNIA

Hobby Center
Electronics Dept., G. E. Lyman
861 Marsh St.
San Luis Obispo, Calif. 92107
Phone 805-943-3942
We sell and repair all types of major R/C Systems

COLORADO

Hood Electronics & Hobbies
5302 Howell St.
Arvada, Colorado 80002
Sales Installation and repair of all makes of R/C Equipment
Phone 303-278-2075

FLORIDA

E.W. Bryant R/C
Box 416
Punta Gorda, Fla. 33950
We service all types of R/C gear—also build radio kits to your specs.
Hobby Center
11602 N.W. 7th Ave.
Miami, Fla. 33168
Phone 305-581-4441
The Hobby House, Inc.
397 Hwy. 17-92
Casselberry, Fla. 32707

GEORGIA

Hobby Distributors
4 Avondale Road
Avondale Estates, Ga. 30002

ILLINOIS

Stanton Hobby Shop
4734 Milwaukee
Chicago, Ill. 60630
Contronics
Karr Mfg. Div.
Box 92
Thomasboro, Ill. 61878
Radio Control Central
Box 58122
Chicago, Ill. 60656
Phone 312-545-9815

LOUISIANA

Mercury Hobbies, Inc.
5733 Michoud Drive
New Orleans, La. 70122

MICHIGAN

Walt Glemser
5829 Shandonish Ave.
Allen Park, Mich. 48101
Phone 381-5708
1st Class Comm. Licensee
for Legal Transmitter
Repair and Freq.
Verification/System
alignment

MINNESOTA

Al Schwartz
2787 Fernwood
St. Paul, Minn. 55113
Exclusively World Engines

MISSOURI

C.W. Reed
5408 Woodson Road
Raytown, Mo. 64133
Contact Charley for quote on Blue Max Systems
Supertigre and OS
Max Engines

NEW HAMPSHIRE

Dembros Hobbies Inc.
58 Lake St.
Nashua, N.H. 03060
Low low prices on R/C equipment plus fast repair service

NEW JERSEY

J.A. Dencke
528 Soremus Avenue
Glen Rock, N.J. 07452
For same day service ship entire system with fully charged batteries.

R/L Control Systems
P.O. Box 280
Denville, New Jersey 07834
Tel. 201-627-7070

NEW YORK

Jerry Behrens
615 Monroe Blvd.
Long Beach, N.Y. 11561
Phone: 516-432-1874

NORTH CAROLINA

Triangle Technical Products
500 Glenwood Ave.
Raleigh, North Carolina 27603
Phone 919-833-1131

OHIO

Country R/C
12450 Amity Rd.
Brookville, O. 45309
4 miles S. of Interstate 70
We repair most R/C equipment and repair of all makes of R/C Equipment
Columbus, O. 43213
Nearby Hobby & Sport Shop
4409 Mahoning Ave.
Warren, Ohio 44483

OKLAHOMA

Tulsa R/C
1241 S. 15th E. Ave.
Tulsa, Oklahoma 74128
Phone 835-5425
R/C Equipment Sales
FAST Service—
Mail or Direct

OREGON

Strictly R/C
7808 S. W. Capitol Hwy
Portland, Oregon 97219

SOUTH CAROLINA

S & R Hobby Crafts
Electronic Service Dept.
61 Constellation Drive
Charleston Heights
South Carolina 29405
Fast expert R/C service at reasonable prices.

TENNESSEE

Aertronics
109 Chatham Lane
Oak Ridge, Tenn. 37830
R/C equipment—Service—
repair—trade R/C
problems? Free
consultation and advice for
beginners or experts.

TEXAS

Wilson's Hobby Shop
2205 West Bearegard
San Angelo, Texas 76901
Custom built units by
Eldon Wilson. All parts,
stocked for MAN, Blue
Max, Complete repair
for all W.E. radios

VIRGINIA

Radio Electronic Model Shop
800 National Ave.
Winchester, Va. 22601
Phone 703-667-1750
Complete sales and service
Kits and equipment

SOUTH AFRICA

Sean McCullagh
15 Avon Road
Deerp River
Capetown, South Africa

OUR R/C LINE INCLUDES:



WORLD'S EXPERT'S SERIES 6ch \$460



MK II BLUE MAX SYSTEMS 6 ch \$340

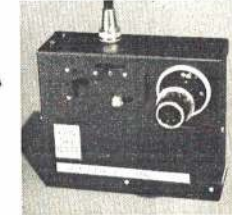

NEW PYLON MIGIT 5 ch \$285

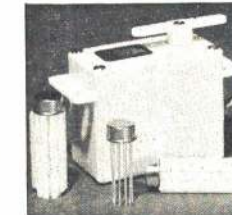

S-5 ASSEM 35.00
S-5 SEMI 24.98
RETRACT 40.00



CATALOG
Price - \$1.00



WORLD ENGINES

8960 ROSSASH AVE.

CINCINNATI, OHIO 45236

A NEW GENERATION...

\$59.50
POSTPAID



LITTLE BIG DADDY 66

- EASY TO BUILD AND FLY
- IDEAL FOR THE BEGINNER
- KIT SANDED AND MACHINE CUT

Write For Free Brochure
TEXAS

**MODELS
UNLIMITED**

1623 DUMAS DRIVE
AMARILLO, TEXAS 79107
AC 806 383-1301

MO-BIPE

(Continued from page 44)

trailing edge. Also draw lines down the middle of the leading and trailing edge of the wing blank. Sanding the airfoil should be done on a smooth surface. Any glue glob will chew up the under-surface of the wing. This sanding is done with a 3 x 12" block with 60 grit paper glued on one side and 220 grit on the other.

The lines that are drawn on the wing blanks are used as guides to shape the airfoil. As one looks down on the wing, the wood above a plane determined by the line on the leading edge and the forward line on the top of the wing is removed by sanding. The airfoil is shaped by removing these wedge-shaped sections. The center section of the bottom wing is left unsanded where it intersects the fuselage. Rough sand the airfoil by using cross grain strokes with the rough side of the sanding block. Do not sand below the guide lines and leave a 1/16" radius on the leading and trailing edges. Use spanwise strokes with the 60 grit paper to even out any ripples. Now remove any sanding marks with the 220 grit side of the block. Cut the ailerons from the lower wing; then cut the hinge slots and glue the lower wing into the fuselage.

The tail assembly is straightforward. Cut, shape and slot these surfaces for the hinges, then glue the fin and the stab to the fuselage.

Efforts have been made to keep the hardware standard, but there are three



+

Graupner

=

THE BEST IN FLYING

CUMULUS

Here is the king of sailplanes, by the king of quality; Graupner. Designed for towline and slope soaring, or power assisted thermal flying, 2 channel; rudder and elevator. Wing span 110 1/4", weight (ready to fly), 56 oz. Foam wings are already balsa covered and sanded, fuselage is one piece of plastic ready to paint, all other parts sanded, and ready for "film" or paint.



\$169.95

CIRRUS

The Cirrus is a 1/6 scale model of a full size sailplane manufactured in Germany. Wing span of 118 inches, overall fuselage length of 49 inches. Fuselage is basically composed of three high impact molded plastic pieces. Wings, tail and stabilizer, are built up in the conventional manner. A high performance soarer for 2 channel R.C.

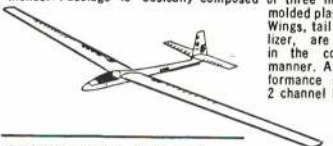

\$79.98

KWIK FLY MK III

This is the world champion model designed by Phil Kraft for acrobatics. Wing span of 59 1/2 inches and will take up to a .60 for 4 channel R.C. equipment. This model is easy to build due to its extensive pre-fabrication.



\$95.98

Dealers, Wholesalers, Write to AHM Today to Order These Hot Items.

Catalogs: CA-27—Gas Model Cat. 10c.
• CA-35—1971 4-color plastic kit cat. (new), 50c • CA-24—1972 Airfix color cat. 68 pages \$1.50 • CA-25—Airfix price list (no pictures) 10c. Allow five weeks for catalogs, by third class mail. For first class mail add 25c for each cat., individually, or 75c for all catalogs, normal ten days delivery.

Mail Orders—try your AHM dealer first. If he cannot supply items desired, send his name and address with your order. Orders less than \$3.00, add 50c handling charge. If the service is not completed promptly, write boss, 1240 Gilbert Road, Meadowbrook, Pa., 19046. For prompt attention to mail order, address to:

CS 2062



ASSOCIATED HOBBY MANUFACTURERS, INC.
627 E. Cayuga St., Phila., Pa. 19120

BUILD AND FLY BROZ MODEL HELICOPTERS free flight RUBBER radio control GAS POWERED

GET...

- PARTS • SUPPLIES • KITS • PLANS • from most complete line of model helicopter accessories
- MODEL HELICOPTER NEWS • the first and only magazine edited exclusively for model helicopter enthusiasts



SEND FOR CATALOG AND MAGAZINE ONLY 60c



BROZ ENTERPRISES, INC.
104 Lake Scranton Rd.
Scranton, Pa. 18505

YOU GET MORE THAN HELICOPTER KIT FROM BROZ



SOLING-M. Scaled from the exciting new Olympic-class three-man keel boat. Length 50 in., mast 60 in., sail area 800 sq. in., displacement 18 lb. For American Model Yachting Association 50/800 "M" class racing. Prefinished fiberglass hull and deck, machined cast-iron keel \$125.00



SANTA BARBARA ONE DESIGN. More than five hundred sold — and #10 can still beat #500! Length 70 in., mast 72 in., sail area 1100 sq. in., displacement 28 lb. Prefinished fiberglass hull, deck, cabin and keel \$165.00

BOTH KITS include finished Dacron® sails, spruce spar blanks, stainless rigging, brass fittings, and die-cast aluminum rudder. For two- or three-channel r/c operation with the Vortex sail control unit.

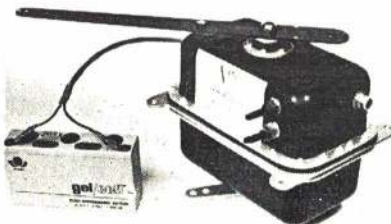

SAIL CONTROL UNIT with gel/cell® battery and charger \$75.00

SEE YOUR HOBBY DEALER

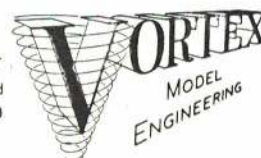

210 East Ortega Street
Santa Barbara, Calif. 93101
Telephone (805) 963-1636

**GOV'T. SURPLUS
MODEL 4 NICKEL-CADMIUM
BATTERY, 1.2 VOLTS**

Rechargeable thousands of times



Sintered-plate alkaline storage battery displays flat voltage curve during discharge, has high discharge rate (up to 50 amps), holds charge for a long period of time. Spillproof, may be used in any position. Approx. 4 ampere-hour capacity. Dimensions: 6" high, 2" wide, 1/2" thick. Approx. weight: 6 oz. Uses potassium hydroxide (30% electrolyte).

Price \$2.50 each, postpaid

MODEL 7 N/C BATTERY, 1.2 VOLTS

Same general characteristics as battery above, but with 7 ampere-hour capacity. Dimensions: 4 1/2" high, 3/4" thick. Approx. weight: 9 oz.

Price \$3.50 each, postpaid

C & H SALES CO.

2176 East Colorado Street • Phone: 681-4925
Pasadena, California 91107

pieces that must be homemade. These are the two horns on the hook and the horn on the rudder. The hook horns are made from 1/16 x 1/4" brass, available from any good hobby shop. This heavy a piece is used so there is adequate contact with the hook to insure a strong solder joint. Solder the right horn to the hook, but leave the left one unsoldered until after the final assembly. The rudder horn can be made from the same material or a lighter gauge. A homemade rudder horn is necessary as a conventional horn will interfere with the elevator travel. Attach all horns to their respective control surfaces. Install the control surfaces but do not glue the nylon hinges in place, as the control surfaces are removed for finishing.

Mount the bellcrank; bend and install the pushrod. Now epoxy the hook release guide tube to the fuselage. Bend the hook release wire, then bind and solder it to the pushrod. The aileron and rudder pushrods are made from 12" Du-Bro "Kwik-Links." Insert the hook into the fuselage. It will probably be necessary to use one or two between the hook horns and the fuselage for spacing. Slide the horn on the left side of the hook, bend the Kwik-Links and temporarily install them. Solder the catch on the hook. It should disengage the release wire with about 15 to 20 degrees

CANADIANS

Space Commander

We now have the new G-45 I.C. system in stock. Complete unit with four I.C. servos and all nickel cad. batteries. Three month warranty fast service and spare parts on hand. Only \$260.00
Complete line of Solarfilm Colours in stock.

New from Complete-a-Pac. Fairy Swordfish kit: 60" span engine up to .60. Complete kit includes plans, hardware, fiberglass cowl, pre-bent wires only \$75.00

We also have the new 62" Zero same as above \$69.00

Plastic Fuselage formers for the CAP Hurricane \$7.95

Canopy for the CAP Hurricane \$3.00

Plans for the CAP Hurricane \$6.95

Cowling (fibreglass) for the CAP Hurricane \$6.95

Send \$1.00 for our 1972-85 page illustrated catalogue. This amount refunded on your first order over \$10.00.

Canadians only

CALGARY HOBBY SUPPLY LTD.

Box 3173 Stn. B. Calgary, Alberta.
118 40th Ave. N.W. Ph. 277-4664.
The model shop whose only business is Model Aircraft.

3 new ways for faster and better finishing from HOBBYPOXY

QUICK-PREP Polyester/Fiberglass Resin

Here's the fast, new way to fill and prepare wood and fiberglass. Fast-acting QUICK-PREP flows on easily, cures rapidly and provides a base primer for all finishing methods. Just two coats followed by light sanding and you are ready to apply paint. The perfect way to insure a perfect finish.

QUICK-PREP Polyester Resin

Complete two-part set / 1 quart \$3.75

Look for the **PURPLE** Hobbypoxy label

QUICK-SPRAY Gloss Hardener

For spray use only, HOBBYPOXY's new QUICK-SPRAY can be used with all HOBBYPOXY colors and clear. Fast curing, highest gloss, the same tough epoxy coating, but faster. So fast, in fact, that brushing is not recommended! Mixes 50-50 the same as regular Gloss Hardener.

QUICK-SPRAY Gloss Hardener

4 ounces \$1.20 / 8 ounces \$1.80

Look for the **BLUE** Hobbypoxy label

FLAT HARDENER (matte finish)

At last! A true flat matte finish is available in a true epoxy. HOBBYPOXY's new FLAT HARDENER gives you that military look without rubbing. Brush it or spray it. Curing time is the same as regular hardener.

FLAT HARDENER (matte finish)

4 ounces \$1.20 / 8 ounces \$1.80

Look for the **GREEN** Hobbypoxy label

HOBBYPOXY PRODUCTS

Division of Pettit Paint Company, Inc.
507 Main Street / Belleville, N. J. 07109

Tatone cast aluminum ENGINE MOUNTS

Engines run smoother and cooler on Tatone Engine Mounts. The cast aluminum absorbs engine heat and provides a solid support for better engine performance. Tatone mounts are one piece and easy to install and are most often specified on magazine plans and in kits. For your convenience, we make a mount for 98% of all engines made and always in stock.

1/2A	Short or Long	-- \$1.75
.09	Short only	-- 2.25
.15	Short or Long	-- 2.25
.19	Short or Long	-- 2.25
.29-.40	Short or Long	-- 2.50
.45-.59	Medium only	-- 3.00
.40RV	Long only	-- 3.00
.60	Short only	-- 3.00
.60RV	Long only	-- 3.50

NOTE: Specify engine, model number and displacement. We will drill mount for your engine at no extra charge if requested, undrilled otherwise.

* Custom mounts for McCoy 21 series engines now available

R/C PYLON MOUNT for .40RV engines

NEW!

Mount, rear nut plate, all mounting hardware incl. only 4.95



1209 GENEVA AVE. SAN FRANCISCO, CA. 94112

down. Mount the motor and tank and bend the throttle pushrod to length. The engine we recommend is the plain bearing Fox 36 RC. This motor is as good as any other and is by far the easiest to install. The throttle arm is in the right place and moves in the right direction (i.e., closes the throttle when moved forward) to permit a straight, short pushrod between the bellcrank and the throttle. It may be necessary to make a long throttle arm to slow down the closing action. The Fox has a very fast throttle. Other engines may require some arrangement to get the pushrod around the tank and perhaps a link to reverse the pushrod direction. This is the kind of trouble that a new Carrier flier would be well advised to avoid.

At this point, the plane is completely assembled except for the upper wing and the struts. Check to see that all the controls function properly. The left aileron will not work properly because the horn on the hook is not yet soldered. It can, however, at least be verified that the pushrods are the correct length. Remove all the controls, the motor, tank and landing gear; the model is now ready to finish.

I suppose every flier has his favorite finishing technique. Plain dope is probably adequate, but an epoxy finish will hold up longer when high nitro fuels are used.

The method I use is as follows: Fill any nicks with vinyl spackling compound. Sand the entire model smooth with 320 or 400 grit paper. Brush on

Fly The Smallest

... the TINI-BLOCK R/C System

2-Channels (2 servos)
Flite Weight 5.1 oz.
with batteries
\$119.95

2-Channels (1 servo)
3.9 oz. with batteries
\$95.00

Factory Assembled Only.
27 MHz prices shown.
Add \$10.00 for 72 MHz.



TRY THIS FOR SIZE

MADE IN U.S.A.

LITE ENOUGH FOR .010 — POWERFUL ENOUGH FOR .60's

Imagine a unit so tiny it even flies 24" models! Now you can radio-control the smallest aircraft, gliders, boats and cars with the CANNON TINI-BLOCK System.

Complete system includes transmitter, receiver-servo block, separate servo (2 channel only), 225 ma nickel-cadmium battery pack, and separate charger. Units completely assembled, wired, ready-to-fly. Standard 90 day warranty.

Transmitter: Small but powerful. Full two-axis stick. Uses 9V dry battery. Size 2 x 4-1/2 x 6-1/2 inches.

Receiver-Servo Block: Fast, precise servo action. Extra-range I.C. receiver. Size 1-3/8 x 1-1/2 x 1-9/16 inches. Weight 2 oz.

C-E3 Servo: 3-wire I.C. amplifier. Lo drain. Write for complete brochure.

The TINI-BLOCK is only one of our six different types of systems.

Size 23/32 x 1-3/8 x 1-1/2 inches. Weight 1.2 oz.

Battery Pack: 225 ma nicads. Switch in harness. Size 13/16 x 1-7/16 x 1-7/16 in. Weight. 1.9 oz.

Charger: Transformer type for shock-free charging.

CANNON ELECTRONICS

13400-26 SATICOY STREET
NO. HOLLYWOOD, CA. 91605
(213) 764-1488

NEW! CONTROL HORNS

At new low prices.

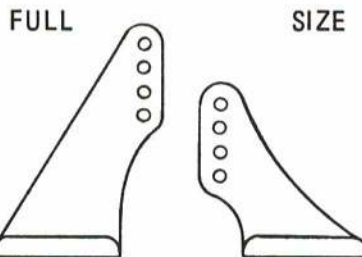

Now mfg. in right & left sets. Shot from virgin natural nylon. Furnished with screws and our original self tapping nut plates.

Stk. #01 - Std. Horn .49¢ pr.
Stk. #02 - Long Horn .49¢ pr.
See your dealer or order direct add .25¢ for post. & handling

ROCKET CITY SPECIALTIES
103 Wholesale Ave., N.E.
Huntsville, Ala. 35811

TESTORS

Hobby Model Products

two coats of clear dope and sand smooth with 320 paper after each. Apply three brushed coats of dope and talc filler and sand with 320 after each. Next, spray a very, very thin coat of Dupont No. 30 auto primer. This can be thinned with dope thinner. Sand this lightly. Now spray on colored epoxy. The primer is necessary as the epoxy will not adhere well to dope. Elaborate spraying equipment is not needed. The PreVal sprayer coats a dollar and one unit will paint a model the size of the Bipe. The epoxy should be applied hot. Heat it in very hot water for half an hour before application—this will greatly speed the drying and thereby reduce the chance of dust adhering to the

finish. Reinstall the motor tank, controls and landing gear, and glue on the struts and upper wing.

The lines and handle are critical parts of the control system, and no matter how careful a job has been done up to this point, the lines must be cut to the correct length or only frustration will result. The lines must be cut so that the distance from the center of the fuselage to the center of the grip is between 60 and 60.5 ft. First, cut the elevation lines so they satisfy your feel of level. Next, hold the handle in a horizontal position so they satisfy your fell of level. Next, hold the handle in a horizontal position so the elevation lines run parallel all the way to the plane. The



for the faster, easier... more fun way to model...

pro-foam

pro-foam... rigid polyurethane pro-foam... used by professionals - available now for the hobbyist... try it... for your largest project or smallest detail... a complete model or accessory...



1. cut it
pro-foam cuts easily with a knife or saw...



2. sand it...
pro-foam sands and shapes quickly... eliminates hours of tedious construction time...



3. glue it
any popular glue is compatible with pro-foam... ambroid, tile-bond, testors, elmer's, epoxy...



4. dope it....
apply your favorite covering and finish directly to pro-foam... silk, silk span, tissue, fiber glass...



5. cover it..
pro-foam is fuel proof and heat resistant... ideal for heat shrink covering...

STOCK SIZES	P/PIECE	P/PIECE	P/PIECE	P/PIECE	
3 x 4 x 12	.90	3 x 4 x 24	1.80	3 x 4 x 36	2.70
1 x 12 x 12	.90	1 x 12 x 24	1.80	1 x 12 x 36	2.70
2 x 12 x 12	1.80	2 x 12 x 24	3.60	2 x 12 x 36	5.40
6 x 6 x 12	2.70	6 x 6 x 24	5.40	6 x 6 x 36	8.10
6 x 12 x 12	5.40	6 x 12 x 24	8.10	6 x 12 x 36	16.20

If no dealer available - order direct - minimum order \$10.00 plus 10% shipping charge

50¢ for sample and information

MODEL MATERIALS COMPANY • 119 MARIPOSA • WAUKEGAN • ILLINOIS • 60085

NEW K&S 12 VOLT FIELD IRON



**MODEL 212
FIELD IRON
PLUGS INTO
CAR LIGHTER
FOR QUICK
FIELD USE!**

**READY TO SOLDER
IN ONE MINUTE!**

**ONLY
\$2.95**

ADDITIONAL SOLDERING TOOLS

**MODEL M300
30 WATT, 110 V
SOLDERING IRON**

**LIGHTWEIGHT
PERFECT BALANCE**

ONLY \$2.95

**BOX OF 4 EXTRA TIPS
M284 \$1.98**

**MODEL M900
HEAVY DUTY
110 V IRON
HIGH CAPACITY
QUICK HEAT**

\$4.95

**BOX OF 3 EXTRA TIPS
M904 \$1.98**

**SEE THESE GREAT TOOLS
AT YOUR DEALER OR SEND
25¢ FOR OUR CATALOG.**

K&S ENGINEERING

6917 W. 59th St. • Chicago, Ill. 60638

R/C BOATERS: PARALLEL EXCUSE US IF WE STRUT A BIT!



Made of high tensile strength extruded aluminum

PARALLEL STRUT \$295 ea.
Complete with:
2 Nyliner Bearings
4 Screws & T-Nuts

1 1/4" Depth
1 1/8" Depth
1" Depth
7/8" Depth
3/4" Depth
1/2" Depth
1" Depth

3/16" Boss
7/16" Boss

SHAFT—steel \$150 ea.
3/16" long

3/16" DIA. PROPELLER SHAFT & DRIVE DOG COMBINATION
Drive Dog—Hardened, plated steel supplied with 8-32 cup point set screw

To be used with any of Parallel Struts at left.

3/16" Bore
3/16" long

LOWER UNIVERSAL JOINT \$235 set
Use with Parallel Strut

Hardened, plated steel.
3/16" to 3/8" shaft—OC610 F & M—7/16"
5/16" to 3/8" shaft—OC509 F & M—3/8"

STREAMLINED TAIL NUT plated
1 3/16" long.
10-32 thread, 75c ea.
OC6PN—7/16"
OC6PNM—3/8"

BALL THRUST BEARING
7/16" O.D.—\$1.80
3/8" O.D.—2.50

OCTURA MODELS
If dealer cannot supply you—order direct—add 10% for postage and handling—Illinois customers include Sales Tax.
8148 NO. MILWAUKEE AVE. • NILES, ILLINOIS 60648

motor is now in its high speed position. Now with the trigger pulled back, tie the throttle line so that it sags slightly more than the elevation lines. Slightly more means "as little as possible without sagging less." Next before the line ends are soldered, check to see that the system has a full range of throttle movement. Lines that are not the correct length in relation to one another are the biggest cause of trouble to a beginning Carrier flier. Minor adjustments in length can be made by using different size line clips.

Flying

The model is now ready to fly. If this is your first Carrier ship, it would be wise to contact an experienced Carrier flier, let him watch you fly and then offer you his suggestions. Carrier does not require great flying skill and endless hours of practice. The rules for Profile Carrier are very restrictive in an attempt to keep the event simple. It is safe to say that if the engine is well broken in and the control system is carefully adjusted, the Biplane will keep up with the best. If you would like to send any comments or suggestions, please send them to me at 433 Arquilla Dr., Glenwood, Ill., or to Don at 1119 Parkside Dr. N., Wyomissing, Pa., 19610.

HP 72 Series Hirttenberger Engines

The most powerful muffler equipped R/C engines in the world!

BOB BECKMAN

(Continued from page 68)

als. One step in construction will require a small lathe, such as a Unimat.

Start with a pair of alleron bellcranks. Get the type with a large hub and plastic bushing. Top Flight bellcranks were used for the proto-

HP40F-RC
Ideal pattern engine
Excellent idle
.90 horsepower
\$56.95
(with muffler)



HP40R-PR
Perfect for RC pylon
Dependable power
1.2 horsepower
\$59.95
(with RC mixture venturi)



HP61FR-RC
Pattern and scale leader
Brute power
1.3 horsepower
\$84.95
(with muffler)



HP61RR-RC
Open pylon and marine use
All new disk rotary valve
1.52 horsepower
\$92.95
(Marine version \$102.95)



HP ENGINES...THE NEW BREED!

Muffler as part of integral design
World Championship performance with handling qualities so gentle they are ideal for sport flying
Schneurle ported for competition power
Lowest vibration of any high powered 61
Coolest running of any 61 engine
Old World craftsmanship and care throughout

JUST OUT!
OLD FAVORITE



PORTERFIELD Collegiate

WINGSPAN 17 IN. OVERALL LENGTH 11-5/8 IN. FLYING WGT. APPROX. 6/10 OZ. KIT NO. 107 2.00

Popular lightplane from the thirties. Used extensively for cross country flying and pilot training. Another addition to the TERN line designed with your enjoyment in mind. New design features, a top quality kit and a beauty of a flying model. OTHER FLYING MODEL KITS BELOW.

Watch this space for more!

- GONE GOOSE 17" Kit No. 101 . . . 1.50
- TRAVELER SAILPLANE 24" Kit No. 102 . . . 1.50
- STARDUSTER SPORTPLANE 16-1/2" Kit No. 103 . . . 1.75
- SKIPPER, DIPPER 2in 11-1/2" & 18" Kit No. 104 . . . 2.00
- de HAVILLAND TIGER MOTH 17" Kit No. 105 . . . 2.50
- NIGHTHAWK SPORTSTER 18" Kit No. 106 . . . 2.00
- RYAN ST 17" Kit No. 109 . . . 2.75

CHECK WITH YOUR WHOLESALE TODAY!

TERN AERO CO., inc.
P.O. BOX 66398
CHICAGO, ILL., 60666

ALL HP PARTS CARRIED IN STOCK—IMPORTED BY



NELSON MODEL PRODUCTS

6929 WEST 59TH STREET • CHICAGO, ILLINOIS 60638 • (312) 586-7101

ADVANCED PUSH ROD SYSTEMS

COMPLETE WITH ALL HARDWARE

from

**SU-PR-LINE
PRODUCTS**

PLAINFIELD, ILLINOIS 60544

NEW PRO ROD T.M.
THE RIGID PUSH ROD SYSTEM

NEW MASTEROD T.M.
THE Flexible Cable PUSH ROD

NY ROD®
THE Flexible PUSH ROD

NEW MASTEROD-XF T.M.
THE Extra Flexible Cable PUSH ROD

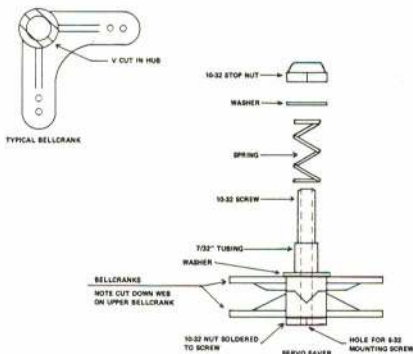

type. The bushings are discarded and will be replaced with a piece of 7/32" brass tubing about 5/8" long. Cut or file a 90 degree V shaped notch in the hub of one bellcrank. Cut the hub of the second bellcrank to a V that fits inside the notch.

Cut the head off of a long (at least 1 1/4") 10-32 steel machine screw and, using a lathe, drill a clearance hole for a 6-32 screw (No. 28) the full length of the 10-32. Thread a thin steel nut onto the end of the 10-32 screw until one or two threads come through the nut. Carefully solder the nut to the screw, keeping the solder away from the long end of the screw. Put the screw back in the lathe and trim off the screw and solder flush with the bottom of the nut. Most hardware stores have a selection of small springs available. Pick out a compression spring that is a free but not sloppy fit over the 7/32" brass tubing. You want a pretty stiff spring, so if you pick one that you can squeeze together between thumb and forefinger, it's either too light or you belong in a circus. Cut the spring to approximately 5/8" length.

Assemble the servo saver as shown in the sketch. The lower washer should just fit over the 7/32" tubing and the upper washer should just fit on the 10-32 screw. Once assembled, the two bellcranks will rotate together, with the spring holding the two in the notch. The force required to separate the bellcranks can be varied by running the stop nut up and down and by changing the length or weight of the spring.

**GEORGE ALDRICH
MODEL PRODUCTS**
3219 SHADY SPRINGS RD, SAN ANTONIO, TEXAS 78230
512-342-6495

- GMA CUSTOM ENGINES FOR ALL EVENTS, THE BEST IN MODELING.
- ABC ENGINES A SPECIALTY—UNIQUE HEAT TREATING & HONING PROCESS. A PROVEN NATIONAL WINNER!
- FULL TUNING & REWORK, CUSTOM MACHINING.
- FULLY TUNED PIPE, MINI-PIPE, OR MEGA-PHONE SYSTEMS.
- CUSTOM WATER JACKETS FOR BOATS.
- FACTORY RECOGNIZED REPAIR & REWORK ON HP ENGINES.
- PROP PITCH GAUGES, GEARED MONOLINE HANDLES, SPEED SUPPLIES
—SEND 25 CENTS FOR PRICE LIST.
- ALDRICH CUSTOM COMBAT PROPS AVAILABLE NOW! 9 x 6, 6 1/2 - 7-75 CENTS EACH.

NAT'L. CHAMPIONS USE GMA CUSTOM ENGINES:
TERRY PRATHER, BRIAN WEBSTER,
HENRY SPENCE, KERRY FREEMAN,
1st C.L. G.Y. JR. SR. & OPEN
"IF THE CUSTOMER ISN'T HAPPY—I'M NOT!"

Enough channels for 8 tiny reindeer

Heathkit 8-Channel RC Systems

Kit-form solid-state flying gear with the flexibility and performance specs to keep your most elaborate model airborne. Choose either single-stick or dual-stick control. Both have switch selection of alternate channel, trim tabs, "buddy" training circuitry. Order the GDA-405-S Single-Stick Transmitter with GDA-405-2 Receiver, GDA-405-3 Battery Pack, four GDA-405-4 Miniature Servos or four GDA-505-4 Sub-Miniature Servos and pay just \$269.95*. Substitute the GDA-405-D Dual Stick Transmitter and pay just \$249.95*. Either way, all batteries and connections are included and you save \$34.70 on the system price. Stocking stuffers? How about the Heathkit GD-69 "Thumb Tach" tachometer, 19.95*, and the Heathkit GD-206 Servo Simulator, 19.95*. Every RCer can use 'em.

*Merry Christmas and Happy New Year from Heath Company
the world's largest manufacturer of kit-form RC*

Send for your FREE 1973
Heathkit Catalog

See the full line of Heathkit RC equipment, plus more than 350 other kits for every interest.



HEATH COMPANY, Dept. 80-1
Benton Harbor, Michigan 49022

Enclosed is \$ _____, plus shipping.

Please send model(s) _____

Please send FREE Heathkit Catalog.

Name _____

Address _____

City _____

State _____

Zip _____

Prices & specifications subject to change without notice.

*Mail order prices; F.O.B. factory. GX-267

the "LIGHTNING-BOLT 21"



- 1-1/2 LB.
- 21-3/4" LONG
- EASIEST KIT EVER
- FIRST .19 MONO OVER 30 M. P. H.
- HULL, DECK & PLANS - ONLY \$25.00
- COMPLETE "71" CATALOG 504 - PLEASE GIVE ZIP CODE WITH ALL INQUIRIES AND ORDERS



G.E.M. MODELS
P.O. BOX 342 - DEPT. AM
BROADVIEW, ILL. 60153
PHONE 312/279-2451

FAMOUS ROTARY ENGINE

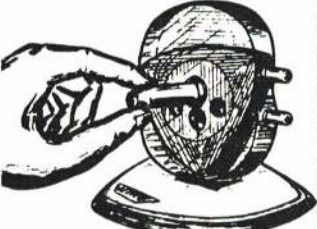

\$1.75
plus
25¢
postage

SEE HOW THE ENGINE OF THE FUTURE WORKS WITH THIS ATTRACTIVE SEE-THRU MODEL. KIT AND TECHNICAL DATA.

Send \$2.00 to: VETCO, dept. A
P.O. Box 23, New Almaden, Calif. 95042

The 6-32 mounting screw is passed through the servo saver and a nut threaded on at the bottom. The screw is then run into a tapped mounting hole on the chassis and the nut jammed down to secure the unit. Note that this arrangement allows the servo saver to turn freely so that normal steering action is not effected by the spring.

BURKAM

(Continued from page 67)

over his machine. Yet two of the maneuvers were left open to the flyer to choose his own. Gene Rock showed such precision and control in the maneuvers that he won the contest without benefit of scale bonus points or any of the scale type maneuvers.

Horace Hagen flew his Hueycobra to second place. He seemed to have enough fingers to spare one to operate his rescue hoist, lowering it from five feet to the ground. Ernie Huber won third place with his timing belt special. While cruising around after his official flight, one of Ernie's belts started to let go. Before he got it down, the belt went completely and he made another "autorotative landing." Some of the fellows tried to earn points for "scale crash," but either failed to announce it before hand, or had it out of proper order in the program.

Ray Jaworski improved so tremendously since the Nats competition that he made fourth place, doing a pretty good job of the hovering maneuvers, right slide, etc. Once he almost clobbered his caller, Gene. But Gene, knowing the sting of rotor blades, made a neat dive and escaped. And in fifth place was "Never Say Die" Sweeney, who with his own private non-exclusive frequency had more flights and more crashes per hour than any other man living. Latest word from him is that a new minimum friction teetering spring on his rotor hub is now giving him the proper feedback force from rotor to fuselage and he is once again flying under control. After some emergency overnight repairs to its tail rotor, Square Tubie made one flight on Sunday. A sticky tail rotor control made the chopper take an unplanned diving swoop at the judges.

GET 'EM AT HOBBY WORLD!
2 GREAT NEW
"40-SIZE" PLANES—
A-6 INTRUDER & CUTLAS
GIVE YOU MORE FLYING
PER GALLON! \$42.95 each

Kits include fiberglass fuselage and vertical fin. Bulkheads and maple engine mounts are installed. Foam wing and stab included in these well-designed kits.

DEALERS—Tired of long back orders? Try us—get your special price list. These kits carry full dealer discount.

1/4 MIDGET WINNERS

- ★ Minnow
- ★ P-51
- ★ P-63 King Cobra

Fiberglass fuselage and vertical fin; foam wing. Firewall installed. Kits include landing gear blocks.

each \$34.95

PROVEN WINNERS FOR PATTERN

- ★ Jim Whitley's Daddy Rabbit
- ★ Jim Kirkland's A-6 Intruder
- ★ Don Lowe's Phoenix V

Fiberglass fuselage and vertical fin. Bulkheads and engine mounts installed; foam wing and stab. Kits accurately cut to designers' specifications.

each \$49.95



ORDER TODAY! Make a list of what you need and write or call for confidential price list. We've got fast service . . . save the Bob Reuther way!

BOB REUTHER'S HOBBY WORLD

6602 HIGHWAY 100 DEPT. A
NASHVILLE, TENNESSEE 37205, U.S.A.
24 HOURS: DAY (615) 356-1225
NIGHT (615) 352-1450

TENNESSEE'S LARGEST SHOP

River Paddle Steam Boat



Now capture the romance of the 19th century river boats with this exquisite model kit of a paddle steamer. Built in N scale, 1:160, the kit features more than 240 parts, molded in seven colors. The finished model measures 13 1/2" long, 2 1/2" wide. See this new kit at your dealer now.

VOLLMER 1973 Color Catalog . . \$1.00
BOYD MODELS No. 10 Catalog \$1.00
STEINGRAEBER Ship Catalog \$2.00
CONSTRUCTO Ship Catalog . . \$3.00
"How to Build Ship Models" . . \$5.95

BOYD MODELS
810 East 14th St Los Angeles, Calif. 90021



C/L ENGINES: FOX .15—\$7.50, .25—\$9.50, .35, .36X—\$12.00, .36XBB—\$15.00, .40—\$13.25; ENYA .09—\$9.50, .15—\$11.00, .35—\$15.50, .45—\$25.00, .60—\$38.50; O.S. MAX .10—\$8.80, .15—\$11.00, .20—\$12.00, .25—\$13.00, .30, .35—\$14.00; K&B .15—\$19.50, .35 Stallion—\$9.50; COX .049 BB—\$4.50, 3/\$12.60, .049 GB—\$5.50, 3/\$15.00, Medallion .049—\$7.50, .09—\$9.10, .15—\$11.25, Tee Dee .010-051—\$9.10, TD .09—\$10.50; MIDWEST Panther, Cougar—\$11.50, Magician 15—\$7.00, Magician 35, Kingcobra, P-51 Mustang, Messerschmitt—\$10.00, 3/\$27.00; TOP FLITE Super Monokote 4—\$23.00, 12—\$60.00, 9 assorted trim sheets—\$5.67, Mustang, Quik Fli III—\$31.50, SE5A—\$33.60, P-40 Warhawk—\$35.00, 2/\$66.00, Contender—\$25.50, Headmaster—\$13.50, Top Dawg—\$12.50, Taurus—\$29.00, Tauri—\$19.50; MIDWEST Cardinal—\$16.50, Little Stik—\$16.50, Sky Squire—\$24.50, Tri Squire—\$13.50, Esquire—\$12.25, Lil Esquire, Tri Squire—\$10.00; STERLING Fledgling—\$19.00, 1-26—\$15.00, 1-34, Rimfire, Lancer—\$20.00, PT-17—\$33.60; JENSEN Ugly Stik—\$40.00, wing kit—\$15.25; BRIDI Kaos—\$39.50, wing kit—\$19.00, RCM Trainer—\$37.00; ROYAL B 25—\$56.50, P-38, Little Stinker—\$48.00, Cessna 310G—\$52.50, Spirit of St. Louis, Cessna 206—\$36.50, Cessna 182, Hein Sr.—\$40.00; AFI Malibu—\$18.50, Monterey, RF-4—\$22.00, high start—\$22.50; Windward—\$18.50; GRAUPNER Middle Stik—\$32.00, Cirrus—\$40.00, Cumulus—\$95.00; VK Cherokee, Navajo—\$28.00, Cherokee Babe—\$20.00, Mini-Flite Rivets—\$22.00; DREMEL Moto speed control—\$14.00, No. 271 complete—\$32.00, No. 281 complete—\$38.50, No. 572 complete—\$43.00; STAFFORD Comanche, Aircoupe—\$35.00, Sperry Messenger—\$32.00; Joy Mars—\$28.00, C-3—\$35.00; UNIVERSAL WHEELS 2½—\$3.60, 2¼—\$3.75, 3—\$3.90, 3¼—\$4.05, 3½—\$4.20, 3¾—\$4.35; HOBBYPOXY I—3/\$2.10, II—3/\$6.30, IV—3/\$4.20; AERO PREC. AT-6 Texan—\$26.00, Touchdown—\$16.75; A-Justo-Jig reg.—\$29.99, full house—\$38.00, fuse adapter—\$8.00.

ALL POSTPAID — INSURANCE ADD \$.30

But she recovered in time, made a wobbly half turn to the left and plopped down on the edge of the runway with no damage. Really, the model is flying extremely well now, and climbs like an express elevator.

Considering the primitive state of model helicopters, it would have been nice to have a couple hours for trimming, adjusting, and getting the feel of the model. However, this was impossible with another contest going on simultaneously. As the art is advanced and skills are perfected there will be less need for adjustments beyond a last minute touch on the needle valve. How about four Heathkit Servo Simulators and some long wires for a pre-contest warmup?

For anyone planning to build Square Tubie, from the sketch in last month's column, I recommend lengthening the fuselage by moving everything ahead of the rotor shaft forward two inches. This puts the CG just about on the rotor shaft. The integral fuel tank was replaced by a 10 oz. square tank (Pylon brand) placed crosswise with the ends visible, showing how much fuel remains. Aluminum hubs or thick bushings are needed on the two plastic pulleys of the second stage to give the setscrews a firm grip on flats filed in the shaft. Also aluminum baffles inside the fan shroud force cooling air to pass close to the cylinder and head and the Murphy muffler.

Get Ready: Bob Lopshire, AMA publicity, tells of a mammoth RC show at the Philadelphia Commercial Museum for four weeks starting March 23, 1974. Mostly static display, but some demonstrations are planned. Since there is a helicopter category, they would likely be wanted in the demonstrations. Some fantastic prizes will be offered. Get busy—it's only a little over a year from now.

Helicopter Parts Source: At long last a source of all kinds of parts and materials, gears, belts, bearings, hard-to-get aluminum, etc. for building model helicopters. For further information write to Broz Engineering, Inc., 104 Lake Scranton Rd., Scranton, Pa. 18505.

Leaders in Authentic Scale

Guillow's
BALSA FLYING MODEL KITS
America's premier line of scale balsa airplanes and simple build-by-number kits. Send 10¢ for complete catalog.
PAUL K. GUILLOW, INC., WAKEFIELD, MASS. 01880

FIRST PLACE WINNER
Best Original Design and Most Outstanding Finish, 18th Annual Toledo Conference.

DARIO BRISIGHELLA SR. says:
I've tried the many newer finishes including the film-type coverings, but
FOR MY COMPETITION MODELS, THE ONLY WAY TO GO IS
AERO GLOSS DOPE

Winning best finish awards with offbeat combinations of Aero Gloss has become a habit with Dario Brisighella Sr. of Oak Creek, Wis. His latest: A "plum-crazy" combination using his own specially blended "international orange," "rich plum," and "ice white," with jet black striping on the widely publicized "VIPER." "It may be that I just think of models and Aero Gloss together," Mr. Brisighella says, "but in thirty years I've never gotten a bad job using it." Which is not such a bad reason to consider Aero Gloss for your next competition model.

Other reasons:

PRE-FORMULATED AND READY TO USE—For dependability, for convenience!

40 DISTINCTIVE COLORS—Providing an unlimited color range for the unique and trend-creating color concepts that contest judges are always looking for.

TOUCH-UPS AND ADDITIONS NO PROBLEM. With Aero Gloss, another matching jar is always available. Leftover paint or mix can be used again.

INNOVATE, BLEND, CAMOUFLAGE! The exclusive Aero Gloss formula comes in military flats, fluorescents, candies, metallics and in spray and brush-on dope.

AT YOUR HOBBY DEALER IN SIZES FROM 1 OZ. TO 1 GAL.

pacta industries, inc., 6725 SUNSET BLVD., LOS ANGELES, CALIF. 90028



R/C Flying Fun!

THE SIMPLE SYSTEM--

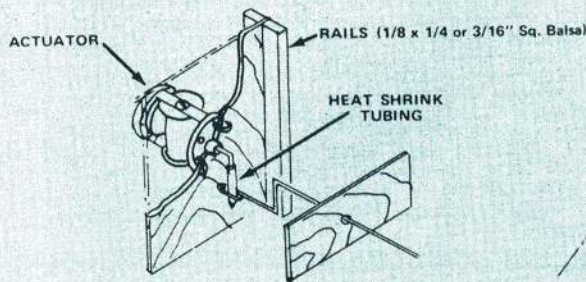

pulse commander

--WITH Nicads and Charger
--From 2.5 to 4.8 oz.

RUDDER-ONLY PULSE IS:

- * LIGHTEST WEIGHT--2.5 oz. for Baby.
- * LOWEST COST--WITH airborne nicad batteries and charger--begin at \$69.95!
- * SIMPLEST--only one moving part, easily serviced and maintained; noise free.
- * VERSATILE--Arrange to suit your particular installation. You can go up or down in size without obsoleting receiver or transmitter. Simple changes of battery pack and actuator allow change. Or add Motor Control to Standard or Stomper--using same battery pack.
- * FULLY PROPORTIONAL
- * GREAT for Beginners--FUN for Experts.

PULSE COMMANDER R-O SYSTEMS

Completely wired, tested and guaranteed with airborne battery pack and charger, but less transmitter battery.

10G15--Baby System	\$69.95
10G15T--Baby Twin System	\$72.95
10G16--Standard System	\$71.95
10G17--Stomper System	\$74.95

26.995, 27.045, 27.095, 27.145, 27.195
Please Specify Frequency

Flite Pak Weights & Recommendations

Unit	Weight	Recommended
Baby	2.5 oz.	Pee Wee .020 Up to 48" gliders
Baby Twin	2.7 oz.	Tee Dee .010-.020 Up to 72" gliders
Standard	4.4 oz.	.049 to .10
Stomper	4.8 oz.	Tee Dee .049-.23

R O PULSE HANDBOOK

WITH
UPDATED CATALOG
Only \$1.00
Refundable First Order

Handbook has expanded data on How Pulse Works, Installation, How to Fly, and much more. Most complete information on Pulse Rudder Only available anywhere.

New catalog is completely updated. Includes many items from major manufacturers.

Price is \$1.00 via THIRD CLASS BULK MAIL. If you wish faster delivery, add 50¢ for turn-around FIRST CLASS service.

ACE RADIO CONTROL, INC. * BOX 301 * HIGGINSVILLE, MO. 64037

NAME _____

ADDRESS _____

CITY _____ STATE _____ ZIP _____

QUANTITY	STOCK #	NAME OF ITEM	PRICE	TOTAL

Master Charge or BankAmericard No. _____

Add \$1.00 shipping-handling for direct mailorders except catalog



MEDALLION 12 VOLT 1 AMP CHARGER

This unit is just it for charging your 12 volt all purpose battery. While designed for car use, its use for modelling is great--will not overcharge. Price is very low considering the high quality. Large alligator clips on battery leads. Newly manufactured--not surplus. Not recommended for charging starting batteries or any other transmitter or receiver batteries.

34K13--Medallion 12 V 1 amp Charger \$6.95

Also available in the charger line are our Vari Chargers designed primarily for flite paks (also may be used for transmitter paks), our Dual Vari Charger, designed for low rate and also heavy duty charging, such as starting batteries, and our H-D Charger, designed for heavy duty applications, such as starting batteries. See our latest catalog for further information and prices.



APOLLO GLIDER "Adjust-tow" Hook

Here is the neatest little gadget that we've seen in a long time. Features instant adjustability for gliders from 2 pounds up. Has keeper to hold the positionable plastic hook. Keeper slides out of the way so you can make instant "on-the-spot" adjustments on the field.

36L335--Apollo Adjust-tow Hook, ea. \$1.75

NICKEL CAD STARTING BATTERY

We have located a sizable supply of surplus 7 ampere hour nickel cadmium starting batteries. These are in good condition. Convenient small pocket size, 3/4" x 2 5/8" x 4 1/2" overall. Are 1.25 volts.

To put into operation charge at 500-700 milliamps for 12 to 16 hours before use. Also recharge at this same rate.

May be used with any glo plug type connector for engine starting.

No. 38K7--Surplus 7 ampere hour wet Nickel Cad Battery \$3.95

LYNAR TOTE-BOX KIT

Easy 15 minute assembly. Handy size--8" by 12". Very strong plywood material. Dividing material included with all box parts precut. Smooth finish easily obtainable. A surprisingly good value considering the price.

13L18--Lynar Tote-Box Kit \$2.98



ALL STAR BIPLANE KIT For Up to .15 Engines--2 or 3 Channels

By Roman Bukolt. Uses two sets of Ace Taper Foam wings for ease of construction.

13L200--All Star Deluxe Biplane Kit \$21.95

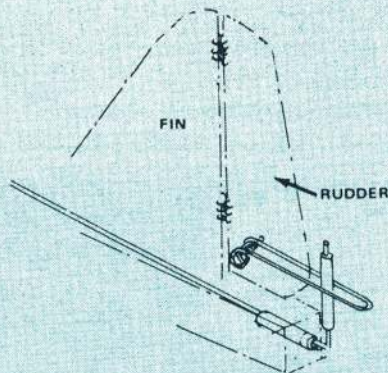

New small PRACTICAL flying machines. These designs really fly--and fly well; not in the novelty class. Easy to build, low in cost, inexpensive to fly. For use in limited areas.



DICK'S DREAM KIT Highly Recommended for Beginners

† 34" Foam Wing sections. † Top grade die-cut wood parts. † For .020 engines. † Commander Baby or Baby Twin. *Owen Kampen design.

13L100--Dick's Dream Kit \$6.95



ACE HIGH GLIDER KIT

† 70" Foam Wing sections. † Precision machine cut and sanded wood. † For .049--Power Pod parts supplied. † Recommended for Rudder-Only--Standard or Stomper. *Owen Kampen design.

13L104--Ace High Glider Kit \$14.95

Watch for New Rudder-Only Plane Kits

TRY YOUR DEALER FIRST--if he does not have it, order direct using coupon for fast and courteous service.

NOW--LOWER PRICE!



digital commander KIT

- * Two channel system using IC's and latest state of the art; may be expanded to 4-6-8 channels.
- * Receiver-Decoder (2) will work with ANY modern 4-6-8 channel digital transmitter on same frequency! Reads aileron and elevator signals--ignores the rest.
- * Receiver-Decoder (2) works any modern digital servo.
- * Receiver-Decoder (2) offer inexpensive way to go with your present system for glider, plane, boat or car: use with extra servos you already have. Or use our combo flite pak: receiver-decoder, two servos, etc.
- * Available on the following frequencies: 27.995, 27.045, 27.095, 27.145, 27.195, 53.100, 53.200, 53.300, 53.400, 53.500

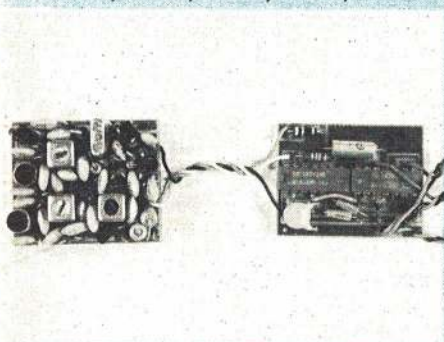

digital commander RECEIVER DECODER (2) KIT

IC's simplify wiring and set up of 2 channel decoder. Receiver is exceptional double tuned front end using discrete components. Complete with detailed step by step instructions.

- No. 12G20—Digital Commander Receiver-Decoder Kit (2) \$27.95
(Less case, connectors, switch)
Please Specify Frequency
- No. 19L50—Deans gold plated 4 pin connector set .95
(NOTE: See D & R connectors elsewhere)
- No. 40L252—CW DPDT Slide Switch .59
- No. 30L21—Switch Guard for above .39
- No. 21K30—Formed plastic Case for Receiver-Decoder. (All models) 2.00



digital commander SERVO KIT

Housed in the D & R Bantam DS3P mechanics, uses WE 3141 IC for ease in assembly. Kit contains motor, pot, wiper and all components required, with step-by-step manual.

- No. 14G20—Digital Commander Servo Kit \$25.95
- No. 14G20L—As above, except with D & R DS2P Linear Mechanics (Less connectors) \$26.95

digital commander FLITE PAK KIT COMBO (2)

If you intend to use Commander Digital (2) with your multi digital transmitter, all you need are the receiver-decoder and 2 servo kits. Combo offers savings over kits purchased individually. Includes 3 connectors, switch, hookup wire for cabling. Everything you need to make complete 2 channel-2 servo pack for your sailplane, boat or car, except batteries.

- No. 12G30—(2) Flight Pak Combo \$59.95
- No. 12G30L—As above, but with D & R DS2P Linear Mechanics \$61.95

Please Specify Frequency

digital commander 2 CHANNEL TRANSMITTER KIT

IC's make the encoder a cinch, and easy conversion later to 4 channel. Built up to a standard of excellence; not down to meet a price. Complete kit with step by step instructions.

- No. 11G20—Digital Commander 2 Channel Kit \$49.95

Please Specify Frequency

2 CHANNEL KIT COMBO

Consists of Transmitter Kit, and all parts of the Flight Pak Combination.

- No. 10G2—Digital Commander 2 Channel Kit Combo \$109.95
- No. 10G2L—As above, except with D & R DS2P Linear Mechanics \$111.95

Please Specify Frequency

BATTERY & CHARGER OPTIONS

While alkaline energizers may be used for Flite Pak, 450 ma Nicads are recommended--4.8 volts.

- 38K33—Nicaid 225 ma Cylindrical cells 2.25
- 38K50—KRD Flat Pack for above (4) 1.00
- 38K35—Nicaid 450 ma Cylindrical cells 2.50
- 38K8—D & R Square Pack for above 1.95
- 38K77—XL-ent 4.8v 500 ma button pak 8.98
- 34L10—XL-ent 225 ma charger kit 3.95
- 34L11—XL-ent 500 ma charger kit 3.95
- 34K22—Varicharger kit 7.95
- 34K21—Varicharger, assembled (Varicharger will charge both 225 and 450 ma and other packs) 9.95
- No. 38K54—Mallory 1603, 9 volt Transmitter Battery 2.25

NEW! NEW! NEW!

digital commander 4-6-8 CONVERSION KIT

You have been asking for this—a kit to let you convert your Digital Commander receiver and 2 channel decoder or 2 channel Flite Pak to more channels. Here it is!

Uses the same reliable proven receiver front end—which has won praise in all sections of the country for its selectivity and sensitivity. Changes on the receiver board at the rear end are minor.

The 2-4-6-8 Decoder requires a new PC board, new IC and some additional components. Simple to wire. An 8 bit chip is used (Cost is only a bit more than a 4) so you are not limited to just a 4 channel expansion as originally planned. You can go on up to 8, if your transmitter will!

Now use your Digital Commander Flite Pak for 1, 2, 3, 4, 5, 6, 7 or 8 channels—depending on your transmitter (Must be one of today's IC units with conventional clocking). Unused signals are simply ignored.

Kit consists of basic components. New IC, PC board, all other required electronic components with complete instructions. No connectors supplied.

- No. 12G8—4-6-8 Channel Conversion Kit \$12.95

TRY YOUR DEALER FIRST—if he does not have it, order direct using coupon for fast and courteous service.



Dear Friend:

We didn't have room in the body of the ad but the announcement immediately below is of importance, so we are including here.

DIGITAL SERVICE CENTERS

In addition to our service center located at the factory at Higginville, Mo., two independent service centers have been established. One is on the East Coast, and is designed for customers living in the eastern half of the United States; the other on the West Coast is designed for customers in the western portion. Central states still will be serviced from the factory. This will expedite service, and return to you, and should eliminate as much down time as possible. We recommend either of these service centers very highly.

They are as follows:

Ace Service Center EAST
Electronic Model Systems
103 Bannister Drive
Hampton, Virginia 23366

Ace Service Center WEST
Hillcrest Hobby Craft
3921 Fifth Avenue
San Diego, California 92103

As you will see in the ad body, the 4-6-8 conversion kits for the Digital Commander Receiver-Decoder and Flite Paks are ready now!



The photo above is the "Tall Texan", a sort of scale using two sections of the Ace taper foam wing and one section of constant. Real beauty, simple construction AND good flying characteristics, are features of this design by John Chapis. Will be published in RC Modeler in 1973.

Speaking of RCM, did you read the article in the December issue on "Pulse Proportional 1972"? If you didn't, we urge you to get a copy. It's well worth your while and it tells the pulse story like it is.



All pulse fans will welcome the Warbirds. This is a kit planned for 1973. May be made into a P-51B, Hurricane Mk II or a ME 109E. Plans show the changes required to make any one. The tail section is furnished uncut, so you can outline for the model you select.

This design is by Roman Bukolt. Features Ace foam wing sections for ease of construction. Right in line with the swing of interest in WW II and the planes of that era.

We'll have more on this important Rudder Only Pulse Proportional kit as we get closer to release date.

For now, we just wanted to show you some of the exciting things that are coming your way—designed especially for the Pulse Commander systems—in 1973.

Keep 'em flying.

Yours sincerely,



Paul
Paul F. Runge

VARI-GLOW

Model Engine Glow Plug Regulator

Voltage may be varied from 0-4V

Indicates blown plugs, flooded engine

Clear flooded engines simply by increasing voltage to plug.

Use any 2V-5V power supply.

Ideal for use with electric starters by tapping battery for 2-4V. May be used with all glow plugs.



\$24.95

PENFORD PLASTICS CORP.

320 Curtis St. · Delaware, Ohio 43015

Phone (614) 369-1901



BOX 26263 - Indianapolis, Ind. 46226

SCALE PLASTIC & Balsa MODEL AIRPLANE KITS

Frog - Airtix - Hasegawa - Guillow's - Kayeff

Cleveland Kits, Plans & Printwood

ACCESSORIES & MODELERS SUPPLIES

Imrie/Risley Paints

Letraset Decals

Badger Air Brushes

Micro Scale Decals

MANY SPECIAL OFFERS

LOWEST PRICES

Send 25c for new 28 page catalog #MA 2A

VIPER (Continued from page 40)

When you get this far, the model should look *great*, now the work really begins. That's right, now starts the rubbing, rubbing, and more rubbing! What I look for in a finish is not the shine, but rather the luster, and the only way to this luster is in the buffing or rubbing process. In my own estimation, most all epoxy-type finishes impart only a shine; real luster comes only from lacquer-based paints. A really great finish is made up of millions of microscopic scratches, reflecting the available light. The more minute these scratches are, the greater the visible luster. The actual grit of the buffing compound used in the final rubbing is therefore very important. This grit must be quite fine, and like wet-sanding, the more water used, the better the results. As in the sanding process, when you think you have it done to perfection, take a break, look at it again, and start over or at least continue.

I hope you'll try this design. If you don't make them yourself, the laminar wing cores are available from Wing Manufacturing Co., Box 33, Crystal Lake, Ill. 60014. I have written a complete, six-page step-by-step construction manual entitled "Building the Viper, My Way." This booklet is available for \$1.00. And if there are any questions you'd like to ask, please feel free to contact me at 1032 E. Manitowoc Ave., Oak Creek, Wisc. 53154. Besides, I know you'll enjoy being Viper-Bitten once you get airborne.

KITS

SEND STAMP FOR 24 PAGE CATALOG

9 HL GLIDERS
10 OLD TIME GAS
2 PEANUT SCALE
11 FF CONTEST GAS
NORDIC & OTHERS
MYLAR THERMAL STREAMER

F.A.I. Model Supply



10802 N. 33RD AVENUE
PHOENIX, ARIZONA 85029

PLANES - ARMOR
LEAD SOLDIERS
ILLUS. CAT. 4A \$1.00

The Hobby Gallery

P.O. BOX 4855

SAN JOSE CALIFORNIA



95117

BLUE RIBBON PART I

(Continued from page 18)

tested were the PS6 with Orbit's second generation IC amplifier.

The modeler cradles the transmitter in the left arm, and grasps the knob at the top of the stick with the right hand. This knob is for rudder control with rudder trim achieved by moving a small

Apollo 2Ch

2 Channel

Steering Wheel type.... \$119.95

Single Stick type..... \$119.95

Two Stick type..... \$129.95

A First Class Radio System
for Boats, Cars, and Airplanes

Royal Electronics
Corp.
2119 So. Hudson St.
Denver, Colo. 80222
303-756-2281



Send \$.50 for 26 page Catalog

new!! WRIGHT J-5 "WHIRLWIND" Scale Model Engine Kit

Early in its development the J-5 gained world-wide fame as the powerplant of Charles Lindbergh's "Spirit of St. Louis" transatlantic monoplane. Other historic aircraft powered by "Whirlwinds" included:

- Bellanca "COLUMBIA" (N.Y. to Germany)
- Fokker Tri-Motor "AMERICA" (N.Y. to France)
- Stinson Detroit "PRIDE OF DETROIT" (around the world)
- Early Ford Tri-motors and military planes.

The Williams Brothers kit representing more than a year of research and development consists of over 150 parts. Molded in two colors of plastic, each kit contains 9 cylinders, crankcase and accessories, including two magnetos, carburetor, oil pump, fuel pump, carburetor air heater, and a display mount.

Engine may be placed on stand, or installed in scale model aircraft.



SEND 25¢ FOR COMPLETE ILLUSTRATED CATALOG

181 B STREET • DEPT. M • SAN MARCOS, CALIFORNIA 92069

SCALE: 1½" = 1'

PRICE:
\$9.95

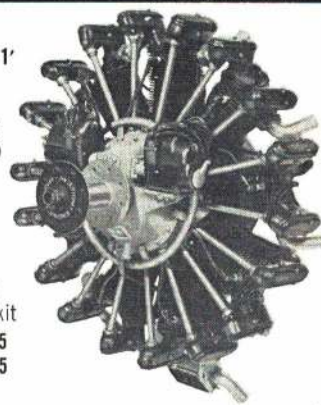

Also available:

Le Rhone engine kit

1½" Scale \$9.95

2" Scale \$11.95

lever protruding from the top of the knob. This is convenient since the right hand need not be removed from the stick to trim the rudder. Elevator trim is located at the right hand end of the transmitter and may be reached with the index finger of the left hand. Aileron trim is at the top of the case where the left thumb rests. At this point, room becomes a problem; the fifth channel is located on the lower right hand end of the case and necessitates either using the right hand for fifth channel (e.g., for flaps) or shifting the left hand to reach. The sixth channel is unique in that it is a toggle switch used for landing gear. Lest the preceding seem a bit tutorial, let us point out that we occasionally are criticized for failing to take into account the many newcomers who utterly fail to figure out where all these controls are by looking at the pictures.

Since the transmitter was on the 72 MHz band, the antenna is base loaded and is one full wavelength. Electronically, the transmitter is quite similar to the previous Orbit designs. Frame rate is approximately 50 per second. The transmitter operates on 9.6 volts with a radiated output of 350 milliwatts. Note that this is radiated output; input to the final is about 800 milliwatts.

Encoding is on a board separate from the RF board and consisting of discrete components. A free running multivibrator sets the frame rate and is followed by six half-shots for the six channels.

We were pleased to note that the new Orbit set uses an external, transformer isolated, dual-output charger rather than the earlier voltage dropping unit built into the case. This is much safer and more flexible—transmitters and airborne packs may be charged independently. Each transmitter has a buddy box arrangement and can be used as a master or trainer.

The receiver has undergone significant redesign. Nominal voltage is 4.8V, but the design permits full flight range on just 3.6V. All components are located on one board now instead of using a small top deck for the decoder. Our 1970 set used three dual J-K flip flops in flat packs for decoding. This has been replaced with an eight bit shift register in a 14 pin dual in-line pack which permits the change to a single deck. Receiver connections are made via miniature plug blocks.

The servo amplifier is a completely new design which incorporates an IC servo amplifier manufactured for Orbit by Texas Instruments. This is a bridge amplifier containing all the active components. Approximately twelve external passive components (resistors, and capacitors) are used for design optimization.

One item of note was the use of a 67 microfarad capacitor no bigger than a small grain of corn for power supply filtering at the servo. This appears to eliminate some of the hum heard from a number of other IC amplifiers examined. The no-load current drain for each amplifier is seven milliamps. Thus the no-load current drain for six servos and the receiver is approximately 90 milliamperes.

Orbit also presented a new 180° travel servo for evaluation. It is based on the use of the same amplifier but uses a feedback potentiometer modified to act as a limit switch thus assuring full saturated servo output drive until full travel is reached. This is a very powerful servo which exhibits over 0.9 in.-lb. of torque at any point in its travel.

The system includes complete mounting trays, mounting grommets and hardware, variety of servo output arms and wheels, and a frequency flag. The physical data and test characteristics are shown in Figure 1 and in the table. Operation was verified to be satisfactory at 0°F and at 150°F. The thrust measured for six servos, and the average, is shown in the table.

Preliminary flight tests were per-

BUILDERS — COLLECTORS BUY - SELL - TRADE

Did you know that there is a nationally advertised monthly publication designed just for you? A publication that deals in individual ads to buy, sell or trade model kits, railroad items, books, magazines, military items, etc.

Available at your local hobby shop or from the publisher — 35¢ per issue — subscription \$3.50 a year. Ad rates \$1.00 for 50 words or less. (One free ad with subscription)

The Collectors Journal

1225 Saxon Ave., Dept. MN
Bay Shore, New York 11706

DEALER INQUIRIES INVITED

MESSERSCHMITT 109E R/C Stand off SMI Kit



\$34.40

Plans \$4.95 — Fiber glass cowl \$9.00

Foam wing cores \$9.00

Aero Modeller Scale ref. 3-views, includes cockpit detail. \$1.50

All sheet balsa and strip to build model including wing sheeting to build model \$16.95. Please add \$2.00 for postage.

WHY BUY A SMI KIT? Best buy at any price — Save \$20.00. Fuselage is built on ¼" sq. box framework. Very little cutting of sheet balsa required. Parts template provided. Little need of pre cut parts in tail assembly or with the foam wings. Plans show built up wing construction. Many more plans and kits available.

61" Span
17½" = 1'
Power — .60

Radio Modeller plans by Brian Taylor, one of England's best scale builders.

"HOW" SCALE. Tailplane slightly enlarged. Original did fly on half tailplane after a midair. Spinner 3½" dia. instead of 3¾" Dia. Back of cowl and tank hatch do not coincide with scale lines.

SCALE fuselage section.

BOB HOLMAN PLANS

P.O. Box 741M, San Bernardino, Ca. 92402

NEW BEST IN SCALE CATALOG .50

SUDDEN SERVICE PLANS

Full-Size Plans — Shipped First Class Mail Within 48 Hours — No Extra Charge

- No. C801, Winnie Mae—Spectacular RC Vega for strong 60 engine in 2'-1' scale, foam and balsa, lots of details. By Monty Groves. Two big sheets. \$4.50
- Also, special 1 1/2'-1' version for FAI scale, 40 thru 60's. Two sheets. Order as No. 0802. \$4.25
- No. C803, Thermal Dart—Enlarged and improved rubber-powered beginner's delight by Frank Ehling. \$1.00
- No. 0804, BV-141 B—Asymmetrical WW II fighter bomber in profile for 049 engine by Terry Aldrich. Easy to make, good flyer. \$2.00
- No. 0901, Sorcerer—Pee Wee 02-powered, free-flight flying saucer uses sheet wing, easy to make by Tenderfoot builder. \$1.00
- No. 0902, Cloud 9—Intricate contest winning Wakefield by Roger Grogory. Plan shows streamlined prop/hub design. \$3.50
- No. 0904, Antoinette—Sigmorino/Zundel RC 98" wing, nearly scale, files well on .36, like powered glider. Plans 3 huge detailed sheets. \$9.00
- No. 0905, Mini Cat—Bud Atkinson scaled down the Cat series, for pulse or light digital and up to 19 engines. Easy to make RC sport flyer. \$2.75
- No. 1001, Phantom—Well-engineered RC Dyna-Jet-powered scale fighter by Ralph Saldívar is practical but noisy model. Highly detailed plane. Jet installation shown. \$4.00
- No. 1002, Hobbit—Simplified Nordic Al by Bob Stalick is steady on tow, all weather flyer. \$1.50
- No. 1003, Charger—1/2A powered sweeping stunter does full pattern on long lines safely. \$2.00
- No. 1101, Autogiro—Simple 049-powered model builds fast and gives unique performance. Pusher prop or motor. \$1.25
- No. 1102, Aerobile—Large scale CL or RC of a famous Waterman roadable plane. Uses 45-60 motor. Wing detachable, car drivable! Large single-sheet plane. \$4.00
- No. 1103, Akromaster—RC scale/stunt model or real aerobatic plane for 45-60 engine. Fast and responsive, easy to make, simple shapes. \$2.75
- No. 1104, Tardon—Formula II semi-scale pylon racer or stunt plane for 40 engines. Won event at 1969 NATS. Groovy flier. \$3.00
- No. 1201, Stiletto—Unique 1/2A proto model uses much-extended motor shaft for clean prop thrust and speed. \$1.00
- No. 1202, King Kong—Huge flat-land soarer for competition use has 12' wing of glass, foam, and balsa. By Sarpolus. \$3.25.
- No. 1203, IO-HI—Six-foot span, 049-powered flying wing is high-performance model with sporting flair. Huge plan. \$3.50.
- No. 0111, Dragon III—Fast graceful competition stunter by Phil Kraft. Uses big 60's and retracts. \$4.00
- No. 0112, Toothpick—Long thin winged combat CL ship is both fast and quick turning. For hot 35's. \$2.25
- No. 0113, Luton Minor—Delightful 10-powered semi-scale RC for three light servos is high-winged parasol monoplane. \$2.25
- No. 0211, Cobra—Steve Wooley's great, smooth-flying CL stunt ship for 35's. Light model, ideal for both FAI and AMA patterns. \$3.50
- No. 0212, Voodoo—Converted Goldberg kit for streamer-towing RC combat, by Ed Sweeney. Two servos with 19 engine. For new event. \$2.75
- No. 0213, Gullotie—Modified from CL for RC combat. Maneuverable, fast, responsive, and fun. Glides well. For two servos and 19 engine. For new event. \$2.75
- No. 0312, EKKO—A compact FAI pattern and sport model for 35 engines. All wood low-winger. \$3
- No. 0311, Skydancer—Two-channel-equipped RC boost glider using alleron and elevator control. Lofted by new, powerful rocket motor. \$2
- No. 0411, P-51 Mustang—Semi-scale 60-powered with ARF Lanier or Dee Bee wing on balsa fuselage. Realistic and quick construction. \$3.25
- No. 0412, Grouper—Unique in appearance, oval balsa fuselage hides a big 60 engine. Easy-to-make stunter for commercial ARF wings. \$3.25
- No. 0413, Dauntless—Low-wing scale profile FF model for sport flying on inexpensive 020 engine. \$1.50
- No. 0414, Nesmith Cougar—Accurate scale CL model of boxy homebuilt. Fine beginner's scale model using 19. A winner with detail. \$3.50
- No. 0511, Five Wagon—Contest free flight model for 1/2A, by James Clem. Diagonal-ribbed wing resists warps. \$1.75
- No. 0512, Platypus—Unusual-looking RC aerobatic seaplane, made with balsa-covered foam blocks. Uses a 60. \$3.00
- No. 0513, Troop Glider and Tug—Two models, one a twin-engine, 19-powered C-46 Profile, the other a scale CG-15 troop carrying WW II glider. Both on one large plan. \$2.75
- No. 0611, Phatom Stunter—Very realistic jet-like model of Blue Angels plane with typical stunt moments and airfoil. For 35-45 engines. \$2.75
- No. 0612, Crusader Stunter—Anhedral wing, ventral fins and full array of missiles and drop tanks. It is a unique but truly competitive flyer on a 35 or 40 engine. \$3.00
- No. 0613, Simple-Fly—Semi-symmetrical CG airfoil low-wing on box fuse. Performance for beginner on 29 or novice contest ship with a 50. \$2.50
- No. 0614, Sopwith Pup—Single or multi-channel, nearly-scale model for 10 to 19 power. Highly detailed plans. Stable flier. \$3.50
- No. 0615, Santana—Jon Davis' contest-winning towliner A/1. Uses fiber-glass boom, stiff wrap-resistant wing. \$2.00
- No. 0711, Phoenix 5—Don Lowe's latest in a series of swept-wing competition stunters for 60 and retracts. \$3.00
- No. 0712, Bonanza/Debonair—Build either V-tail or conventional version of this popular fast light plane for full-house radio and a strong 60. Fine-flying ships, foam wing construction. \$5.00
- No. 0713, I.F.O.—Would you believe a FF 020-powered flying saucer which really flies? Built-up construction looks real. \$1.00
- No. 0714, Helldiver—Semi-scale CL model of WW II torpedo bomber builds fast and is rugged. \$1.50
- No. 0811, Douglas Mailplane—Large FF scale of Western Air Lines M-2 biplane. For 09 power. Could fly with light radio. \$3.00
- No. 0812, Hot Canary—Unique Formula II/FAI racing biplane by Bob Sigelkoff. Although unusual-looking, it is fast and quickly built. \$3.25
- No. 0813, Pogo—Model of Owl Racer for Formula I features midwing, low stab, non-cheeked cowling. Very stable and plenty fast. By Bob Morse. \$3.50
- No. 0814, Flying Fortress—Not a scale plane, but a novelty CL flying medieval castel for a 19. \$2.75
- No. 0911, Fletcher—McCullough's magnificent tri-gear, low-wing crop duster scale job for 60's. Generous area and moments. All balsa. Highly-detailed plans on 2 sheets. \$7.50
- No. 0912, Killer—Fast, responsive combat plane. All-balsa for 35's has many wins. \$3.00
- No. 0913, ACE High—Featherweight 049-powered RO glider uses a set of ACE R/C foam taper and constant chord wing sets. \$2.25
- No. 0914, Sakitum—Highly-developed 40-gram Wakefield plane by Brian Donn features latest trends in gadgets and design. Well-detailed plan. \$3.00
- No. 1011, FAI Man—Competition FAI free flight job for screaming 15's. Simplified construction with warp-preventing wing. Build a winner. \$2.75
- No. 1012, Peregrine—All-out RC slope soaring racer for allerons and elevator. Balsa fuselage with foam wing. \$3.50
- No. 1013, Hi-Pro—Highly proficient slope/thermal soarer. Build several versions from these plans. Balsa wing and glass fuselage. \$3.50
- No. 1015, Marut—Named for the Wind Spirit. Designed for windy weather CL contests. Large-size jet appearance uses 45 engine. Two sheets. \$4.50
- No. 1111, Longster—Large-size free flight scale ship for 09 power, also ideal as small RC. Construction similar to real plane. \$2.75
- No. 1112, Buster—Built-up profile Goodyear racer well-streamlined and a winner. For hot 15's. \$1.75
- No. 1113, Bippi-Bipe—Delightful scale-like rudder-only or GG model for single channel and 09 engine. A fun plane. \$2.75
- No. 1211, Fireball—Jim Walker's great design presented as it was by Bruce Lund. For ignition 23's or smaller on glow. \$2.00
- No. 1212, Brooklyn Dodger—Sal Taib's great old-timer FF job presented as it was by Bob Harrah. For ignition 23-35 or smaller glow engine. \$1.75
- No. 1213, Canus—Sixty-powered and large-size FAI aerobatic RC plane. Very quick building. \$4.00
- No. 0125, Firecracker—FAI scale RC pylon racer with special fast airfoil and homemade retracts (in text), a winner by Bob Root. \$3.50
- No. 0121, Penguin—Unusual scale CL flying model of post-WWI pre-flight trainer. Simple and RC-able. Uses 19 to 35 engine. 3-views on plan. \$2.50
- No. 0122, Pay-Up—TedDee 020-powered AMA Pay Load event winner also nice for sport FF. Simple and sturdy. \$1.50
- No. 0123, Nifty Novice—049 thru 15 power for monoplane or biplane Tenderfoot CL trainer. With power, bipe is stunable. SPECIAL PRICE \$1.00. Decal included.
- No. 0124, P-38—Semi-scale WWII fighter with single 049 files rudder-only pulse RC with ACE mini-foam wings, others usable. \$1.25
- No. 0221, Big Flapper—Large high wing is docile flyer for a 60 engine and 4 channels. Nice trainer/sport plane. \$3.50
- No. 0222, BV-170—Three 35's power this sort-of-scale German profile fighter. It is big, pulls hard in flight, stunts too. \$4.75
- No. 0223, Canard Drop-Off—Rubber pusher sport flyer drops its prop and rubber when unwound, then drops a piggy-back glider. All balsa and files great. \$2.00
- No. 0224, Cardinal—Excellent FAI European-type RC pattern plane of foam/balsa construction. Up-to-date ship if for 60's, suitable for retracts. \$4.50
- No. 0321, Turbo-Pilatus Porter—Fine flying CO2 or Rubber powered FF scale model and scale floats for ROW. All on one plan. \$1.50
- No. 0322, Little Bird—Midwing RC pattern plane handles wide range of power up to 71's, yet is small in size. \$3.50
- No. 0323, Two For the Show—Biplane CL stunt for 049 Tee Dee. This one offers precision flying in small areas, great for practice. \$1.50
- No. 0324, 2T—ACE-foam-winged RC trainer for 049 power carries 2-channel bricks with case. Ample wing area for long glides too. \$2.00
- No. 0421, Quarter Pint—A 020-powered Tenderfoot free flight patterned after an antique design of 30 years ago. With decal. \$2
- No. 0422, RCX4—Bat-like winged sport RC plane for big motors, 4-channels, and crowd pleasing flights. \$4.50
- No. 0423, Squeeze-Banger—FAI combat anyone? Fast flying 15 ship from Canada is a winner. \$2
- No. 0424, Dragonette—Compact version of Kraft's Dragon Fil uses hot 40 and files just like a big one—fast and smooth. \$3
- No. 0521, Satellite 1000—Huge and highly-detailed plans for one of FF's most winning designs. For screaming 40's. \$8.50
- No. 0522, Lil' Rebel—Fast and very durable 15 Goodyear CL racer is a consistent winner. \$2.25
- No. 0523, Pegasus—A take-apart RC job designed for transportation in its own box. Full house with a 19, stunts well. \$2.50
- No. 0621, So-Long—miniaturized Old-Timer for 020 power event and sport flying. Easy to make. \$1.50
- No. 0622, Denight Special—Well updated four-year-old Forum I racer by deBolt has many unique features for speed. All balsa construction. Two-sheet plans. \$2.00

AAM PLAN SERVICE

733 Fifteenth St., N.W.
Washington, D.C. 20005

Please send the following plans by First Class mail, at no extra charge. I enclose \$_____ for payment.

For foreign orders please add 25% for postage.

Name _____

Address _____

City _____ State _____ Zip _____

PLAN NO. COST

_____ \$ _____

_____ \$ _____

_____ \$ _____

_____ \$ _____

_____ \$ _____

_____ \$ _____

Total: \$ _____

No. 0723, Quikie Mk 4—RC competitor for Class A and B. Conventional looking low wing flies easily, builds very fast. \$2.00

No. 0821, Capstan—For one- or two-channel RC, a small sport/scale all-balsa glider. Has a fine glide. \$2.00

No. 0822, Nemesis II—Howard Rush's winning AMA Combat ship. Ultra-light, balsa and silk, very quick. \$2.25

No. 0823, Apteryx—New style Mylar-over-foam wing on fast, tough, AMA Combat plane by Robert Meilen. Construction offers perfect airfoil and tapered wing. \$2.25

No. 0824, Ryan SC—Unusual 049 free flight scale model is low wing with excellent flight stability. Flies fast and handles wind easily. \$2.75

No. 0825, S.S.P. RC Helicopter—Gene Rock's very successful large trainer helicopter needs only 40 to 45 size engine. Designed for home builder with minimum machined parts, gyro-stabilized tail rotor, all-belt drive, 4-channel radios. Also recommended is Plan No. 0826 with full-size drawings for all special machined parts. \$2.00
AAM will present up-dates on the design during 1973 as experience of readers and designer shows need.

No. 0921, Hot Pants—Jerry Nelson's large-bodied, realistic-looking, home-built type RC Pattern design. Smooth flyer uses all-moving stab. \$4.00

No. 0922, Aqua-Vent Floats—Simple curves make these easy to build. Sized for 15 to 30 powered planes. Designed for quick lift-off with low power. \$2.50

No. 0923, Vertigo—A CL vertical take-off-and-landing biplane. Uses throttled 19 for power. Really flies, lots of fun. \$2.75

No. 1021, Bronco—A Class I or II Navy Carrier plane for two 19s or two 29s of the OV-1A C.O.I.N. fighter. The large plan sheets. \$6.00

No. 1022, Lockheed 81—Unique highly-detailed scale biplane of Lockheed's first airplane. Original dates to 1921. Design by M. Groves, uses a 40. Two sheets. \$7.00

No. 1023, Quasimodo—An odd-looking four-channel RC Sport job for 35s. Shoulder wing, tail dragger. A fun flyer. \$4.00

No. 1121, Warlock—Mid-wing, tandem bicycle retractable, all-flying stab, and swept wing are features of this 60-powered Pattern ship by Jim Wilmot. Large plan. \$6.50

No. 1122, Sweet Pea—"V" tailed CL stunter by Dennis Adamisin is consistent winner with semi-scale Good-year-racer appearance. Takes smooth 35 or muffled 40. \$3.50

No. 1221, Spitfire—Highly detailed, two sheet plans for 60-powered retract-geared CL scale model. A Nats winner and seventh in CL Scale World Champs. \$7.00

No. 1222, David—An Al Nordic for competition with A2s is stronger, smaller, easier to make, and has lower wing loading. \$1.75

No. 1223, Quicky 500—Glen Spickler's club pylon racer goes fast but is very quick-building, long-lasting, easy to fly and land. For TR type 40s. Great for grass-field sites. \$2.75

No. 1224, Snoopy—Sport flyer and trainer for 09 thru 35. Can use Top Flite Headmaster wing. \$2.25

THIS MONTH'S PLANS

No. 0131, 720 Turn—Clarence Haught design Class B FP. Conventional design, high pylon wing, big plan. \$4.00

No. 0132, Viper—Toledo Design and Finish winner, big State-of-the-Art Pattern ship by Dario Brisighella. Sr. for good 60s and retracts. \$2.00

No. 0133, Mo-Bipe—Contest-winning Navy Carrier profile fuselage biplane. Thin wings go fast and slow. Takes a throttled 35. \$1.75

YOUR AMA NUMBER PRINTED ON 25th ANNIVERSARY NATS SHIRT



Official Commemorative Two Color Insignia
AMA Number in LARGE 2" Characters
Contrasting Blue Trim
Sizes: Mens - S,M&L - Youth-M,L&XL
\$3.50 plus 50¢ postage per shirt
Send size & AMA number to:
Fagel Brothers - Suite 2401
3930 Pine Grove
Chicago, ILL. 60613



G45 SPACE COMMANDER Proportional System with Exclusive Integrated Circuit Servo Amplifier

Micro Craft offers the ultimate in dependability and economy. Our products are the result of continuous research, extensive field testing, incorporating the most advanced design techniques.

*All Sets Include Nickel Cadmium Batteries and Charger
Suggested List Prices.

*G25 2-CHANNEL, 2 Servos. 27MHZ \$119.95 / 72MHZ \$129.95
*Uses standard dry cell pen cells (not included)
G45 4-CHANNEL, 4 Servos. 27MHZ \$259.95 / 72MHZ \$269.95
G55 5-CHANNEL, 4 Servos. 27MHZ \$295.95 / 72MHZ \$299.95
G65 6-CHANNEL, 4 Servos. 27MHZ \$325.95 / 72MHZ \$329.95

PROVEN IN
THOUSANDS OF
TEST FLIGHTS

MICRO-CRAFT CORP. DEALER INQUIRIES INVITED. SEND FOR DESCRIPTIVE LEAFLET
314 FIFTH AVE., Dept. N.Y., N.Y. 10001

formed in a test airplane from our workshop and a couple of glitches were encountered (Green and white frequency). Receiver tuning was checked and was found to be off slightly. Ground range was about 15 feet with the antenna removed. The receiver was retuned and ground range was a normal 65 feet. This was investigated with Dick Dunham, the Orbit designer. The reason was found to be a slight drift in a particular brand of receiver crystal used for a short time. The problem has been corrected by change to the original supplier and by initiating "bake-in" of the units which used the substitute crystal.

Tests of the system were quite satisfactory. It has been our experience that

the Orbit designs are very conservative—plenty of power output, excellent receiver stability and sensitivity, and servos that are really steady. The problem encountered with the crystal is non-recurring. We had minor criticism of the system; the pins of the plugs are somewhat tedious to mate. This also was discussed with the designer and it was found that pin design has been changed to add a taper at the end so that engagement is easier. The stick neutral was found to be a little loose as shown by about one degree of non-linearity at stick neutral as may be seen in the figure. The author has found this to be characteristic of single stick transmitters in general—it is difficult to tighten up a

Changing Address?

Please let us know in advance
— five weeks notice would help!
For fast service, attach current
mailing address label in space
provided. Then PRINT full name
and address below.

Check correct box —
and enclose payment

One year \$9.00 Three years \$23.00
 Two years \$16.00 Renewal

Name _____

OFFER LIMITED TO

Address _____

U.S.A. AND CANADA

City _____ State _____ Zip _____

AMERICAN Aircraft MODELER

733 Fifteenth St. N.W.

Washington, D. C. 20005

New

Model aircraft fabrication/ finishing products (Superior to Epoxy)



FABRA-TEX CORP.
P.O. Box 310
Waterville, Ohio 43566
Phone (419) 878-5646



All purpose two part contact glue. Has initial tack & variable set-time which you adjust (10 to 20 min.). Designed for balsa-wood, plywood & plastic. \$2.95



Extra light filler. Has variable set-time which you adjust (10 to 30 min.), sands like chalk in 30 to 60 min. & hardens in 24 hrs. Lighter than other fillers. \$2.95



Extra durable primer/ finish paint. Produces fast, light & strong finishes. Can be used as base coat under monokote or solarfilm. Quarts \$4.99 Pints \$3.49

Monty Moncrief — President of Fort Worth Thunderbirds . . . National Fun Fly Champ chooses the power and dependability of



Other contests which Monty has won with his Fox Eagle 60: 1st Place Class A.. Texas Open, 1st Place Class A.. Oklahoma City, 1st Place Class A and High Point Category . . . Corpus Christi, Internationals. Monty is looking forward to many more wins with his Fox Eagle 60 and his beautiful model pictured above.

FOX EAGLE 60

Wt. 14 oz.
Disp.804
RPM 11,500
With 11-8 Prop

\$49.95



Fly American-Made Engines



5305 TOWSON AVE.
FT. SMITH, ARK. 72901

closed-bail, single stick with the added wiring, etc., that must pass through the tubular stick.

We understand that the industry is selling a high proportion of single stick transmitters, presumably to newcomers who feel it will be easier to fly. Unfortunately, we are not qualified to say, having flown two-stick for years. The single stick is much more difficult to design and fabricate for precision, thus costs a fair amount more. The choice is up to the individual, but we think the beginner should get the feel for both before buying.

Characteristics - Orbit 6-12

Dimensions*

Transmitter

8W x 6-3/8H x 2-1/8T

Receiver

2-5/8L x 1-9/16W x 13/16H

Servos (PS-6)**

2-1/8H x 3/4W x 2L

Airborne Battery pack (four 450 mah cells)

2-5/16 x 2-5/16 x 5/8

Total airborne weight

Approximately 12 ounces with 4 servos

Transmitter output

300 mw radiated

Receiver sensitivity

Approximately 2uV

Servo Thrust

2.8 lb. at 9/32 radius

Servo Torque

0.8 in.-lb.

System Accuracy

(End-to-End)

See Figure

* Dimensions—Inches

** Length includes mounting lugs, height includes output arm.

Jay Lewis Presents . . . The Hobby Market

SPECIAL
Limited Time Only!!

Buy an EK 6 Ch. Champion . . . \$349.95
or

Buy a RCM 800 6-channel . . . \$380.00
and

Get your choice of one plane
and one motor free!

Pick from below:

Ugly Stick	Fox 40 R/C
Fun Fly	Fox Eagle 60
Lucky Fly	Enya 45 BB
Kaos	Enya 60 BB
Sr. Falcon	Webra 40
Fledgling	K&B 40 FR or RR
P-51	Veco 50
P-40	Merco 29

Merco 61

Don't pass up this deal
Pro and Beginner alike
SATISFACTION GUARANTEED

Specials: Super MonoKote Opaque 3/15.00, transparent 3/16.80, metallic 3/19.50; Solarfilm opaque 3/13.50, transparent 3/15.00, metallic 3/18.00; Super Shoe 2.35; MonoKote Iron 10.00; Goldberg Main Retracts 7.95; Goldberg full set 14.75; K&B standard long or short plugs 5.50 per card; K&B R/C plugs 11.25 per card; Fox R/C Plugs 7.95 per card; Dremel tool 27.00; Dremel delux home workshop with accessories 40.00; control line kits: Lucky Sport, Flitestreak, Ringmaster, Buster, Shoestring, 3/16.50; Miss Behave, Nobler, Dolphin, Akrobat, 12.00; Midwest ME 109, P-51, Skyraider, P-40, Ugly Stick, Kaos, 38.50; P-51 30.00; P-40 33.00; Sr. Falcon 25.00; Falcon 56 14.75; Tigertail 67.95; Windward 18.00; Windfree 23.50; Motors: Fox 35 11.99, 36 11.00, 40 13.25; R/C Motors: Fox Eagle 60 34.00; Enya 45 31.50, Enya 60 III BB 42.75; K&B 40 RR or FR 24.00 Veco 61, w/muffler 49.95; Webra 40 43.00, 61 Blackhead 60.00 (plenty of Webra parts), Props by the Doz. 25% off.

Send check or money order to the Hobby Market. Sorry, no C.O.D.'s. Texas residents please add 5% sales tax. Add 30 cents for insurance. Phone Day-(817) 626-1182; Nite-(817) 731-3174.

PO Box 2172 Ft. Worth, Texas 76101

BLUE RIBBON PART II

(Continued from page 20)

Finishing a fiberglass airplane takes a little different method. The wings and stab were silked over wood. The control surfaces were finished with Francis resin and dope. The fuselage posed another problem. The seam line on the fuselage was sanded smooth and then filled with spackling compound. This makes for a seamless looking joint. Sand the fuselage with 320 wet to get a surface that will hold the dope.

I earlier said that Jim Kirkland has a winner and I mean that. This is not an airplane that is only for him. It performs well for anyone. This has got to be the smoothest flying airplane I've



M.n.M.
RADIOMODELS

929 S. CEDAR RD.
NEW LENOX, ILL. 60451
R/C PLANES - BOATS - CARS

P.O. BOX 28 - NEW LENOX, ILL. 60451
Phone: (815) 465-2898



R/C DISCOUNT CATALOG .50¢

SPECIAL CUSTOM PROPS

- highest quality maple
- perfectly balanced
- all popular 11" dia. sizes

PRICE: \$ 3.00 each

MOST ORDERS SHIPPED U.P.S. THE DAY RECEIVED

flown yet. Even with a lousy pilot, this airplane makes the pilot look good. The rolls are true and axial. Loops are a joy to behold because they are round. Retracts, and this airplane will let its ears fly back in the wind and go. But here is the cincher—when you get ready to land, this airplane will slow down. After you kill the power, give it a couple of seconds to bleed off the airspeed.

I tried many props and recommend using a regular TF wood 11-7/8" for all around performance. With this pitch, you do need a safe, low idle for landings. Add a dose of up trim and be prepared for smooth consistent SLOW landings.

Incidentally, this writeup primarily concerns the Intruder with fixed gears. I have 1 3/4" nose and 2 1/2" main wheels on it. The other two Intruders have Goldberg and Rom-Air retracts respectively.

I hope that those of you who chose this project are as happy and satisfied as I am. I have two Intruders and a third one on the way.

MARONEY

(Continued from page 66)

claims you get the effect of four control functions using only two servos. When ghosting along in light lift, holding a little up elevator drops the flaps to optimum camber position. When really moving out, or for inverted flight, holding down elevator gives negative camber effect for lower drag and more inverted lift. Coupling ailerons to rudder reinforces the turning power, and results in "instant," on-a-dime turns. The ailerons and flaps are combined in a single surface (flaperons) by use of a simple but ingenious crank assembly. This crank includes a snap-out connection to the wing pushrods, for necessary crash proofing. The moving stabilizer includes a "Flettner tab" elevator, just like the ones on many full-size planes (such as the "Cherokee" and "Cardinal"). This is not a balance tab, but moves in the same direction as the stabilizer, doubling the available elevator power for guaranteed spin entry. Building time required is short since most parts are cut to shape, requiring a minimum of trimming during assembly. A complete hardware package is included having pre-bent wing rods, fully assembled flaperon crank unit, all control horns and cranks, K-links, good quality hinges, wire for pushrods, etc. All wood is selected for suitability of grain and weight for specific application. Spruce and ply is used intelligently to hold down weight while keeping the model rugged. Parts are machined eliminating die-crushed parts!

The prototype flies well in winds from four mph to over 40 mph providing a wide speed range. Design is weighted in favor of

European CARD MODELS

PLANES, SHIPS, ARCHITECTURE; IN FULLY COLORED, THREE DIMENSIONAL, CUT OUT AND ASSEMBLE SCALE MODELS FROM PAPER. THESE DETAILED CONSTRUCTIONS SUPPLIED AS PRINTED SHEETS, CODED LINES, PLUS A "METHOD SHEET" IN ENGLISH, SUPPLEMENT FOREIGN LANGUAGE INSTRUCTIONS TO PROVIDE NECESSARY DIRECTIONS.

ONLY IN CARD

The JUMBOS
7-1463 DORNIER DO-X (1:100) \$1.94
7-1823 BOEING 747 (1:50) \$3.15

SIX MILITARY PLANES (FIVE TYPES) (1:50) \$ 4.08

special

Large Transports (1:50)
7-933 DC-7C 36" SPAN \$1.80 (\$ 3.30 Reg.)
7-989 CONSTELLATION \$1.80 (\$3.30 Reg.)
7-900 ELECTRA \$1.30 (\$2.30 Reg.)

#1204 SCHARNHORST 37" \$4.75
#1203 LEIPZIG 27.8" \$3.10
#1205 KARLSRUH 26.4" \$3.10
#1210 LUTZOW 30" \$2.75
#1021 ONASSIS' CHRISTINA 15" \$1.25 (WATERLINE 1:250)

7-1893 \$ 4.25
D-LZ 127 GRAF ZEPPELIN 1:200 FOUR FEET LONG

Catalog \$.25 (Free With Order)

Shipping Charge
\$.35 (UNDER \$ 2.50)
\$.59 (TO \$ 4.99)
\$1.03 (TO \$ 9.99)
*\$1.35 (\$10.00 & OVER)
* Calif. \$1.10

Foreign Orders
Postal Money Order or Bank Check, collectable in U. S. Funds without charge

California Residents
5% Sales Tax
NO C. O. D.

JOHN HATHAWAY
410 W. 6th St/Box 1287
San Pedro, Calif. 90731

FAI WORLD



CHAMPS
PRO LINE Electronics Inc.

WRITE FOR OUR NEW CATALOG

P.O. BOX 7733 • PHOENIX, ARIZONA 85011 • TELEPHONE (602) 264-3213

American Aircraft Modeler 87

ONLY
\$3.95

50¢ hand. chg.
Ind. Res. Add
2%

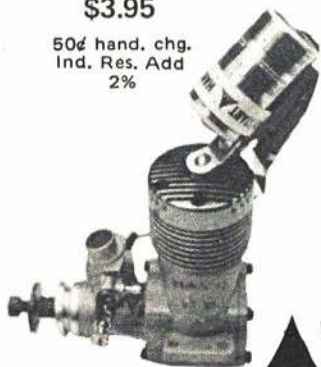

FOR KWIK HANDY STARTS

HAND|START

A POCKET SIZE UNIT
THAT PROVIDES HOT STARTS
AND IS VIBRATION PROOF!

- RECHARGEABLE GE NICAD
- DUBRO KWIK KLIP

PROVED THRU "CONTEST TOUGH" FIELD TESTING!



D A ENTERPRISES
BOX 335, HAUBSTADT, INDIANA 47639
MANUFACTURERS FOR THE AERO MODELER

slope soaring requirements, but has proved an excellent thermal machine also. This semi-aerobatic glider performs consecutive rolls, true spins and limited inverted flight capability. The kit is priced at \$28.00 and requires Washington State residents to add \$1.40 sales tax. Terms are cash with order, post free (add \$1.00 for air mail). Write Superior Flying Models (4001 South 275th Pl., Auburn, Wash. 98002).

FAI Summary: AMA's new FAI Activities Committee is now beginning to function with concentration on reviewing U.S. proposals for changing FAI rules and procedures, and also to establish a unified U.S. position on these as well as proposals from other nations. Past AMA President, John Patton is Committee Chairman supported by John Spalding, Committee Secretary and the following appointments to date: (1) All team selection program administrators: Dave Linstrum (FF Outdoor), Bud Tenny (FF Indoor), Laird Jackson (CL), Tom Rankin (RC). (2) All Contest Board chairmen: Joe Boyle (FF), Jean Paillet (CL), Bill Northrop (RC), Claude McCullough (Scale). (3) Various special interest representatives: Norm Page (RC Pattern), Cliff Telford (RC Pylon), Dan Pruss (RC Gliders). (4) Various major organization representatives: Bror Faber (NMPRA), Dick Lyons (NFFS). The committee makeup provides for several channels of communication for anyone interested in providing inputs to FAI rules-making. Any of these (Contest Board, team program, organization, etc.) can be used to submit ideas for consideration, AMA HQ can also be used—copies will be forwarded to the appropriate committee members.

RC RPV

(Continued from page 58)

installed. This gave the plane good performance and a speed of about 60 mph, or 1/10 the projected full-scale speed of 600 mph. A model air field was constructed to 1/10 scale, and the feasibility tests were ready to start.

Larry took up his position as "pilot" inside the control van, looking at the TV screen on which the picture from the TV camera in the nose of the Wave-master would be projected. Bob was outside, alongside the makeshift runway. Bob, having visual contact with the plane, held the master transmitter; Larry had the "slave" or "buddy box" transmitter in the van. Thus, Bob could position the Wavemaster until Larry, looking at the TV screen, achieved ground, horizon, and target acquisition. Then control shifted and Larry flew the model on the strafing runs.

A second experiment was simulated air-to-air combat. A semi-scale P-51 RC

1973 R/C PRODUCTS DIRECTORY

SIG MFG. CO.

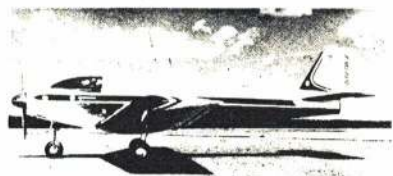

KOMET

Wing span 67" Area 670 sq. in.
Engine .45-.60 Weight 7 lbs.
Mat'l. Balsa fuselage, foam wing
Sug. retail price \$37.95 w/balsa
\$42.95 w/plywood

Designed by Maxey Hester and performs the complete AMA and FAI patterns in the hands of a sport flier.

PICTURES

SPECS

PRICES

SPECIAL PRE - PUBLICATION OFFER

TO BE DELIVERED JANUARY 2, 1973

OFFER EXPIRES DECEMBER 31, 1972

\$2.00

hundreds & hundreds & hundreds of listings

every manufacturer represented

most up-to-date information

only directory like it available

AFTER 12-31-72

\$2.25

post - paid

SEND TO: R/C PRODUCTS DIRECTORY
733 15th Street, N. W.
Suite 526
Washington, D. C. 20005

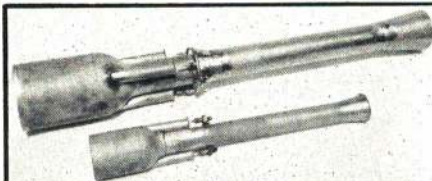

Engine Model JS-200		Engine Model JS-200	
Length	38 inches	Length	21 inches
Diameter	6 inches	Diameter	3 inches
Max. Thrust	Over 10 lbs.	Max. Thrust	Over 3 ounces
Price	\$88.00	Price	\$68.00

Small jet engines for Model Aircraft . . .
Boats . . . Race Cars . . . Experimenters.
Operates on propane fuel. No rotating or
vibrating parts. Throttleable between 50%
and 100% power.

THERMO-JET

BOX 1528 KERRVILLE, TEXAS 78028

(512) 367-2148

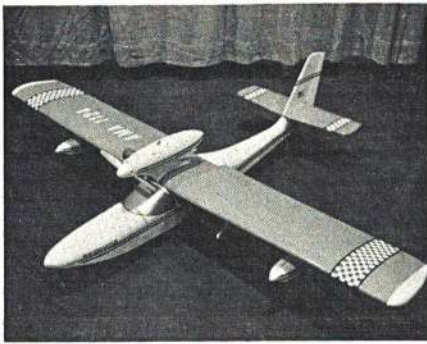

The Wavemaster seaplane before transformation into an RPV. Model available in ARF kit from King RC Distributors designed by Ken Willard.

model, flown by a third modeler, was chased by the Wavemaster with Bob Smith at the controls until the P-51 appeared on the TV monitor screen. Then Larry took over, got on the P-51's tail and closed in to firing range.

Finally, a simulated "kamikaze" mission was performed. A crepe paper barrier, approximately 15 ft. wide and three ft. high, was strung between two poles. A bull's eye was painted dead center. The Wavemaster was flown into acquisition position by Bob Smith. Then Larry, flying by reference to the TV monitor, directed the model towards the banner and scored a direct hit. The motion picture which recorded this is spectacular—to say the least—especially to an RC audience.

Once again, the techniques of the sport of RC flying were utilized to pursue an important objective of the U.S. Department of Defense; at a great savings to the program and, in turn to the American taxpayer. This low-cost feasibility demonstration showed both the capabilities and the limitations of the concept and pointed the way towards further sophistication required in order to increase the capabilities. All this at a cost less than one tenth of similar programs.

An "off-the-shelf" RC model, modified to accommodate the airborne TV camera and controlled by an "off-the-shelf" RC transmitter and receiver, demonstrated that there is, in addition to its recreational value, a technical and scientific utility capability of RC whose potential is only beginning to achieve a measure of recognition. It is this aspect of RC—which doesn't get headlines—that RC enthusiasts must continue to foster, promote, and publicize. And progressive companies, like Lockheed, who are using some of our equipment in research and development, are helping to improve the image of RC modeling at the same time they're saving money.

It's a good deal all around, and it's fun, too.

PEANUT SCALE!

PLANS • WHEELS & SUPPLIES

Complete catalog 25¢
W. C. Hannan, Graphics
Box A, Escondido, Ca. 92025



OUNCE & GRAM SCALE

ONLY \$3.50

Measure both ounces & grams. Just the thing for weighing out those wings, stabs, rubber motors & small R/C units. Great for weighing balsa wood. 9 Oz. or 250 Grams Capacity.

SCALE SPOKED WHEELS

9 SIZES
1/2" - 5/8" - 3/4" - 7/8"
1" - 1 1/8" - 1 1/4" - 1 3/8" - 1 1/2"



At last a light and strong scale spoked wheel for both indoor and outdoor rubber scale models as well as light gas jobs. Each wheel will support 3 lbs. static pressure yet weighs less than 1 gram. Made of silk thread and balsa wood with teflon bearings.

\$3.85 PR.



KOSMIC

- K/15 Glow w/Tuned Pipe \$32.95
- K/15 Glow FAI \$29.95
- K/15 Glow Marine w/Tuned Pipe \$36.50
- K/15 Diesel \$29.95
- Marine Gear Box \$16.95
- Spare parts in stock.

HAND LAUNCH GLIDER KITS

- M&P "Flash" 17" Span \$1.98
- M&P "U.S. Kid" 18" Span \$1.98
- M&P "Polly" 18" Span \$1.98
- M&P "Bo-Weevil" 17" Span \$1.98
- M&P "Sweepette" 19" Span \$2.25
- M&P "Mini-Flash" 11 1/2" Span \$1.39
- 4 K's "Lil Eaglet" 14" Span \$1.25
- 4 K's "Eaglet" 18" Span \$1.50
- Sig "Flip" 14" Span \$.79
- Sig "Pigeon" 12" Span \$.69
- Jasco "G-12" 12" Span \$.79
- Jasco "G-24" 24" Span \$2.25
- Jetco "Thermic B" 20" Span \$.98

FREE FLIGHT RUBBER KITS

- Jasco "X-12" 12" Span \$.98
- Jasco "X-18" 18" Span \$1.45
- Tern Aero "Starduster" 16 1/2" Span \$1.75
- Tern Aero "Gone Goose" 17" Span \$1.50
- Tern Aero "Tiger Moth" 20" Span \$2.50
- M'West "Gollywock" 32" Span \$4.95

Add 50¢ for postage, \$2.00 Deposit on C.O.D., Closeout List 25¢

MASTER CHARGE
BANK AMERICARD
AMERICAN EXPRESS

TELEPHONE 283-6446 area code 312

7 AMP STARTING CELL

ONLY \$5.95



KOH PELLETS 50¢

Our regular \$4.95 7 AMP. Nickel-Cad starting battery plus the new Dubro "Kwik-Glow" cord set... \$2.00. \$6.95 value..... ONLY \$5.95

BLUE MAX SYSTEM

4 Ch. Factory Assembled \$219.50
4 Ch. Semi-Kit \$179.50
4 Ch. Full Kit \$169.50

MICRO-MODELS SCALE OLD-TIMER (PRE-1942) FREE FLIGHT KITS .024-.049 POWER

These are scaled down versions of proven classic designs with full size detailed plans, select balsa, pre-cut (not die cut) parts & jap tissue. Ideal for R/C, using "Ace R/O" package.

- MM1. 1941 "Request" 30" Span \$5.95
- MM2. 1940 "Mercury" 36" Span 6.95
- MM3. 1940 "Clipper" 36" Span 7.95
- MM4. 1940 "Ranger" 30 1/2" Span 7.95
- MM5. 1938 "Twin Cyclone" 35" Span 5.95
- MM6. 1937 "Cavalier" 36" Span 7.95
- MM7. 1935 "Miss America" 36" Span 7.95

- FF 8. 1/2 A "Buzzard Bombshell" 6.50
- FF 9. B-C "Buzzard Bombshell" 22.95
- FF10. Austin IGN Timer (Sm. Med. Lg.) Ea. 2.25
- FF11. Smith IGN Condensers Ea. .50
- FF12. Hi-Tension Leads Ea. .25
- FF13. Ignition Coils (as available) 4.95
- FF14. D-T Timer 5.50
- FF15. M&P D-T Fuse .35

3 LINE BELL CRANK AND HANDLE



Combines motor speed control with elevator on U-Control models.

HANDLE..... \$6.95
B'CRANK-UP. OR INV. \$3.50

Stanton Hobby Shop Inc.

4734 NORTH MILWAUKEE AVENUE
CHICAGO, ILLINOIS 60630

BIGGEST SALE EVER!
the price is going up
SAVE 45%

**buy it
now!**

CHRISTMAS SPECIAL

Plans and helpful hints for the beginning modeler are featured. Instruction and information are stressed, but the biggest thing is FUN! The magazine is designed for the boy or girl from seven on up. Take advantage of the only model hobby magazine written for beginners.

FATHERS and GRANDFATHERS

Here is **THE** magazine for
your son or grandson!
We have planes, cars, rock-
ets, in every issue!

One Year
6 **BIG** issues
only

\$1.10 off newsstand prices **\$2.50**

or

Two Years
12 **GREAT** issues
only

\$1.70 off newsstand prices **\$5.50**

USE THE HANDY ENVELOPE TO ORDER!
OFFER EXPIRES DECEMBER 31, 1972

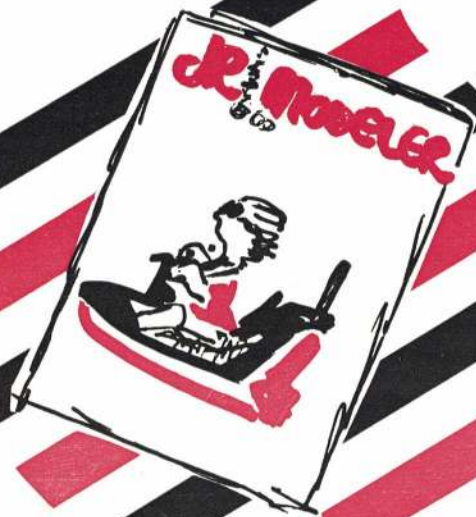

**FOR THE ULTIMATE IN
SCALE
THINK AEROTEC**

German WW I Fighter

ALBATROS D-5A

2" to 1' Scale—58-1/4" Span—.60 Disp.



A Custom Crafted Kit only \$89.95

French WW I Fighter

SPAD—XIII

2" to 1' Scale—53-7/16" Span—.60 Disp.



A Custom Crafted Kit only \$69.95

Plans only,	w/Rib & Formers
Albatros D-5A. \$9.95	\$31.95
SPAD-XIII 9.95	29.95
Fokker DR-1 8.95	29.95
Eindecker 8.95	27.95
Bcing P26A 9.95	31.95

All above 2" to 1' Scale

DR 1 Triplane 3" to 1' Scale Plans. \$14.95

Special engine & 3 inch accessories available—send 25 cents for catalog.

TRIAD wood ARF. only \$59.95

AEROTEC MODEL ENGINEERING, INC.
Box 116, Lincolndale, N.Y. 10540
(Dealer Inquiries Invited)

EDITORIAL

(Continued from page 15)

hobby happenings. Attendance is not by a small minority, but by all modelers, at least at the local level. Modelers like to get together to "talk alot."

MONEY SPENT ON THE HOBBY

We already know that modelers are an affluent bunch, well educated, and generally between 20 to 50 years of age. They are good spenders. The following chart relates the above list into buying power for each group. Please note the total spent. These figures are related to the total AAM readership based on single copy sales average. In addition, the retail value of sales as published in *Craft, Model and Hobby World* for modeling in 1971 was \$200 million.

Buying power is very important. It indicates the strength of our hobby and this magazine. We have the largest reader buying power of any model hobby magazine.

The figures were arrived at by multiplying our average monthly paid circulation, 86,000, by the percentage of the whole for each of the monetary categories. The number of readers in this group is then multiplied by the median of that particular monetary category. For instance 19.4% of our readers spend \$11-15 per month, therefore 86,000 readers x 19.4 = 16,684 readers x \$13 = \$216,892 per month.

**HOBBY HELPERS
FULL SIZE PLANS**

Group Plan 465 3 oz. 60 cents

Jimmie Matters's record-breaking Lockheed Vega—modeled as control line beauty by Walter Musciano. Spans 60"; length 34"; for .45-size or similar power.

Simplified control line autogiro—designed by Ole Dan Nielsen. Rotor diameter 34"; length 37"; takes .45 to .65 size engine with motor control.

Group Plan 966 6 oz. \$1.10

Lockheed Lightning P-38. Semi-scale stunt control-line model by Law McFarland, uses twin .19's with throttle control for shooting landings.

Thorp Tiger. Famous home-built aircraft in radio control model form by Jess Kriesser. Takes a .35 engine.

Group Plan #953C 1 oz. 45¢

Focke-Wulf FW 190 German World War II control line flying scale fighter model by Walter Musciano. 3/4" to 1' scale; takes engine from .14 to .29 cu. in.

A/2 Viking Nordic Towline Glider by British Champ Bill Farrance. These are HALF-SIZE plans with full size ribs and cross sections.

Group Plan #166 6 oz. \$1.10

"Interceptor Five" by Harold deBolt. Latest in famous designer's series of outstanding R/C Multi Class planes. Spans 67 1/2 inches; 50 inches long; uses .61 size engine.

For Special Handling of Plans only	8¢ per oz. 1st Class	Latest Catalog send 15¢ to cover handling
	11¢ per oz. AirMail United States and Possessions only	

HOBBY HELPERS
1543 STILLWELL AVE. • BRONX, N.Y. 10461

**You Just
Put Your
Hands
On A
Winner!**

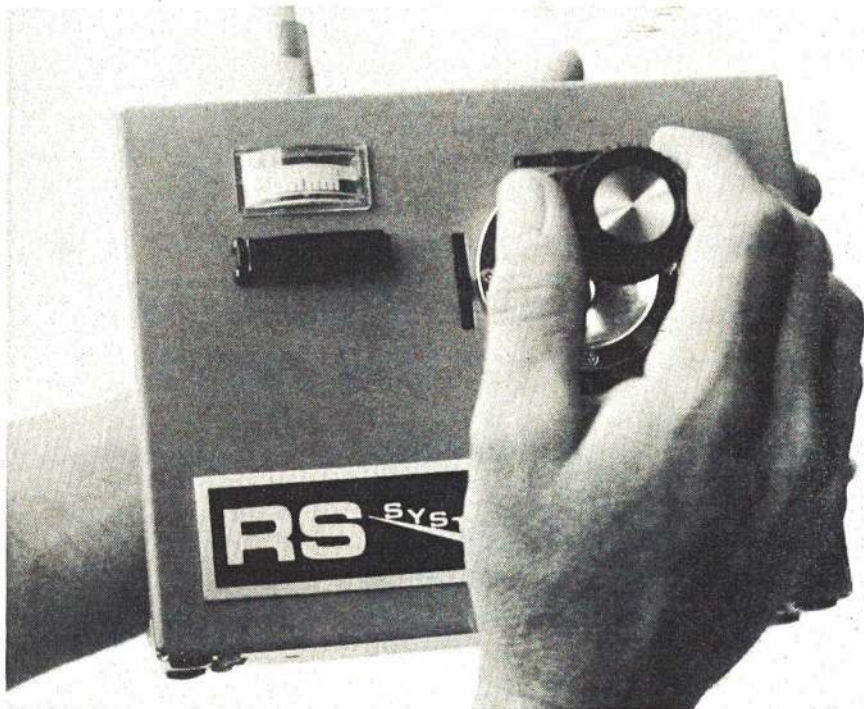

**WRITE FOR A FREE
BROCHURE TO:**

**RS SYSTEMS 2407 S. BROADWAY
SANTA ANA, CA.
92707**

Statement Required by the Act of October 23, 1962: Section 4369, Title 39, United States Code showing the Ownership, Management and Circulation.

1. Date of Filing: October 15, 1972
2. Title of Publication: American Aircraft Modeler
3. Frequency of Issue: Monthly
4. Location of Known Office of Publication: 733 Fifteenth Street, N.W., Washington, D.C. 20005
5. Location of the Headquarters or General Business Offices of the Publishers: 733 Fifteenth Street, N.W., Washington, D.C. 20005
6. Names and Addresses of the Publisher, Editor and Managing Editor: Publisher: Edward C. Sweeney, Jr., 5026 Eskridge Terrace, Washington, D.C. 20016. Editor: Edward C. Sweeney, Jr., 5026 Eskridge Terrace, Washington, D.C. 20016. Managing Editor: Anna Maria Nunez, 5952 Searl Terrace, Washington, D.C. 20016.
7. Owner: Potomac Aviation Publications, Inc., 733 Fifteenth Street, N.W., Washington, D.C. Stockholders: Catherine H. Sweeney, 4013 Douglas Rd., Coconut Grove, Miami, Florida; Edward C. Sweeney, Jr., 5026 Eskridge Terrace, Washington, D.C. 20016.
8. Know Bondholders, Mortgagees, and Other Security Holders, Owning or Holding 1 Percent or more of Total Amount of Bonds, Mortgages and Other Securities: None
10. Extent and Nature of Circulation:

	Average No. copies each issue during preceding 12 months	Actual No. copies of single issue published nearest to filing date
A. Total No. Copies Printed	125,315	133,775
B. Paid Circulation	36,400	36,900
1. Sales through Dealers and Carriers, Street Vendors and Counter		
2. Mail Subscriptions	47,501	52,562
C. Total Paid Circ.	83,901	89,462
D. Free Circulation by Mail, Carrier or Other Means:		
1. Samples, Complimentary, and Other Free Copies	400	510
2. Copies Distributed to News Agents, but Not Sold	40,827	43,528
E. Total Distribution Office Use, Left over, Unaccounted Spoiled After Printing	187	275
F. Total	125,315	133,775

I certify that the statements made by me above are correct and complete.
(Signed) Harvey E. Cantrell
Business Manager

SUPERSCALE
WW II SCALE AIRCRAFT PLANS



Send \$ 25 for DEPT. CA71
Brochure to: Box 201 Arlington, Texas 76010

The chart on page 6 indicates each monetary category and what it represents on a MONTHLY basis. There were 118 readers who did not know how much they spent. Because of their income level these were added to the \$16 to \$25 category.

WHERE IS THE MONEY SPENT?

Hobby Shops	50.3%
Mail order	33.6%
all others	16.1%

These figures are not different from national averages for most every other industry. The percents will change only slightly with economic situation of the nation. When the consumer has more money (than usual?) he spends locally.

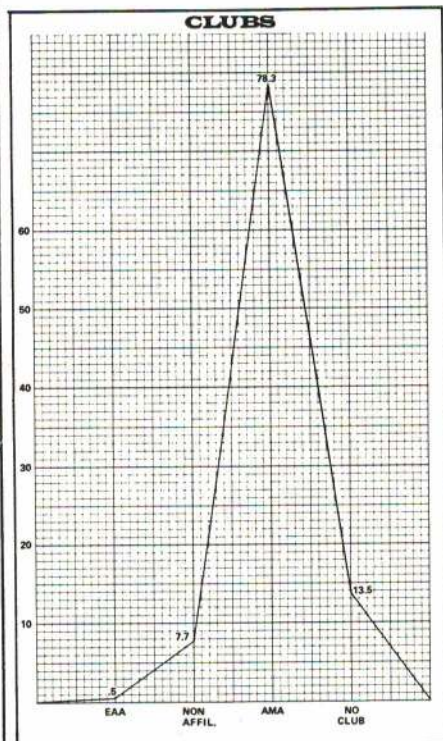

FINGER TIP ADJUSTMENT—NO SCREWS, NUTS, BOLTS OR TOOLS NEEDED

E-Z JUST

CONTROL HANDLES

"Hot-Rock", Ideal for everything from 1/8 A's to speed. Pre-formed loops for quick hook-up. Full-tested for 150 lbs. min. Hot fuel-resistant plastic handle. 4" size.

\$1.50

E-Z-JUST TEST STANDS. Quick, sure lock-up for any engine..... \$2.75

At All Leading Dealers

PHIL-LEYS

BUFFALO 25, N.Y.

IN CANADA

ACADEMY PRODUCTS



EVERYTHING FOR THE MODELER

Canadian Modelers: Canadian Dealer
Write for an ACADemy CATALOGUE. Inquiries Invited.
75 cents, Postage free. Wholesale only.
ACADEMY PRODUCTS LIMITED
51 Millwick Drive, Weston, Ont., Canada.

TRY US . . .

When in Cleveland, Have Fun, Visit Us . . . You'll Be Glad You Did!

LARGE STOCK FROM THE WORLD OVER

Airplanes, Ships, Railroads, Cars, Rockets, Plastic Kits, Accessories, Supplies, Books, Tools,

78 Page Catalog \$1.00

216-749-4750

NATIONAL HOBBY

5238 Ridge Rd. Cleveland, Ohio 44129

EXCLUSIVE FOR THE MODELER
FROM DEMBROS HOBBIES

CHECK THE STARS THAT
MAKE UP STARFLITE

STAR- FLITE

\$199.95



- ☆ Extra Transmitter Power Output
- ☆ Fixed Frame Rate Logic
- ☆ New Rand 2 Axis Sticks
- ☆ White Vinyl-Clad Trans Case
- ☆ Provisions for Buddy Box Installation
- ☆ Lowest Cost Basic—Full House System
- ☆ Charger and All Nicads Included
- ☆ New 2-Wire Battery Pack
- ☆ New 3-Wire Servos
- ☆ I.C. CHIP Receiver Decoder
- ☆ I.C. CHIP Bridge Servo Amplifier
- ☆ Small Size—Lightweight
- ☆ 90-Day Factory Warranty
- ☆ Choice of Servos—C-E1, C-E2, C-E3
- ☆ Choice of Flat or Square Battery Pack

27 MHZ w/C-E1 servos ● 72 MHZ, add \$10.00 C-E2 and C-E3 servos, add \$3.00 per servo

The full retail of this high quality radio will be \$269.95 — introductory offer of \$199.95 good 'til January 31, 1973

Dembros

HOBBIES, INC. 54 LAKE ST. WASHINGTON, D.C. 20004

AREA CODE 803 / 812-6482

COMPETITIVE PRICES Plus NO SALES TAX IN N.H.

For fast service send M.O. or bank check. We allow personal checks to clear before we ship. Bank-america and Master Charge accepted. Include M.C. Interbank Number. (lower left corner) and expiration date.

When he's pinched, he bargain hunts at the mail order shops.

MAGAZINE CONTENT PREFERENCE

As Editor, I'm glad to see that the magazine is well read as presented. Modelers do seem hungry for more product information and how-to-do-it features. Further, we find that modelers in each category read all the feature articles in each issue even in categories they personally don't participate in. However, the survey suggests some changes in the balance of the categories; future issues will reflect this.

ADVERTISEMENTS LIKED BEST

No tabular results will be shown since not all advertisers appeared in the May '72 issue. An interpretation of the results is: hobbyists want informative, clear, uncluttered ads. Factual information is preferred to institutional advertising.

OBSERVATIONS BY THE POLLSTER

Here I sit, pen in hand (a rather crippled hand), thinking that I must have been a little off my gourd to have suggested a Readership Survey. I did not think that we would receive such a response. Work makes me break out in a cold sweat.

But enough of this self-pity! We found out many things about you and what you like. You are a modeler who is different from the preconceived notion held by non-modelers. You are an educated modeler, skilled in the use of your hands and mind. In striving to get the most out of your hobby you are continually designing and redesigning your models.

You are dedicated to the hobby as indicated by:

- Your membership in AMA.
- Amount of money spent on modeling.
- Attendance at shows and competitions.
- Your modeling preferences.

We also gained an overpowering indication of where our modelers are coming from. The sound of a model airplane acts like a magnet. It will draw anyone within a mile radius—just to watch. The next time one of these non-modelers asks you a question answer him the best you can. The more people that enter modeling, the stronger our hobby will become.—Joe Wright.

M. E. DIESEL ENGINES

HERON .059 CU. IN.
\$14.95 P.P.

SNIPE .091 CU. IN.
\$15.95 P.P.

SNIPE R. C. — \$16.95 P.P.
SILENCER — \$4.45 P.P. EACH ENGINE

HOBBY HIDEAWAY DELAVAN, ILL. 61734



BRYCE PETERSEN'S

\$21.95

TOUCHDOWN



NEW all-balsa wing construction
Full size plans
Formed landing gear
All die-cut parts
Wing options:
48" trainer
42" performance (semi-sym w/ailerons)
Extra wing kits \$8.95
3 or 4-channel
.15-.25 engines
Length 34 inches
Weight 3 lbs.
Simple construction

Dealer and jobber inquiries invited

AT-6 TEXAN

High performance semi-scale
.29-.40 engines
53" wingspan
416 sq. in.
4 1/2 lbs.
all-balsa construction
as seen in Sept. R/C Modeler

\$38.50

AERO PRECISION
P.O. Box 152
Tipton, Indiana 46072



SPIN A WIN! FLY Tornado

Get MORE travel-from-torque!
Every Grish-engineered
TORNADO Propeller has true pitch...
delivers MORE of your engine's power.

PROPELLERS

YELLOW NYLON

Blade	Tractor	Pusher	each
5 1/2	3	5 1/4	30¢
6	3	6	35¢
7	4	7	50¢
8	4	8	65¢
5 1/2	3	5 1/4	below in white, too
6	3	6	9
7	4	7	9
8	4	8	85¢
9	6	10	1
10	6	11	1
11	8	11	1
12	8	12	1
13	8	13	1
14	8	14	1
15	8	15	1
16	8	16	1
17	8	17	1
18	8	18	1
19	8	19	1
20	8	20	1
21	8	21	1
22	8	22	1
23	8	23	1
24	8	24	1
25	8	25	1
26	8	26	1
27	8	27	1
28	8	28	1
29	8	29	1
30	8	30	1
31	8	31	1
32	8	32	1
33	8	33	1
34	8	34	1
35	8	35	1
36	8	36	1
37	8	37	1
38	8	38	1
39	8	39	1
40	8	40	1
41	8	41	1
42	8	42	1
43	8	43	1
44	8	44	1
45	8	45	1
46	8	46	1
47	8	47	1
48	8	48	1
49	8	49	1
50	8	50	1
51	8	51	1
52	8	52	1
53	8	53	1
54	8	54	1
55	8	55	1
56	8	56	1
57	8	57	1
58	8	58	1
59	8	59	1
60	8	60	1
61	8	61	1
62	8	62	1
63	8	63	1
64	8	64	1
65	8	65	1
66	8	66	1
67	8	67	1
68	8	68	1
69	8	69	1
70	8	70	1
71	8	71	1
72	8	72	1
73	8	73	1
74	8	74	1
75	8	75	1
76	8	76	1
77	8	77	1
78	8	78	1
79	8	79	1
80	8	80	1
81	8	81	1
82	8	82	1
83	8	83	1
84	8	84	1
85	8	85	1
86	8	86	1
87	8	87	1
88	8	88	1
89	8	89	1
90	8	90	1
91	8	91	1
92	8	92	1
93	8	93	1
94	8	94	1
95	8	95	1
96	8	96	1
97	8	97	1
98	8	98	1
99	8	99	1
100	8	100	1

3-BLADE NYLON
Metallic Aluminum Color

GRISH BROS.
ST. JOHN INDIANA 46373

HERE'S A SAMPLE OF OUR LOW PRICING...

TOP FLITE P-51 MUSTANG
Control line scale
37" span, .29-.35 engines
17.95 List price
14.35 Lindco Catalog
11.99 JANUARY SPECIAL!



ORDER NOW AND SAMPLE OUR FAST SERVICE!

We stock just about all the brand name or off-the-wall items you can think of—PLUS there's a 90% chance of your item(s) being in our catalog—AT A DISCOUNT! SEND FOR OUR 72-PAGE, ILLUSTRATED CATALOG NO. 53. (Please enclose \$1 for mail—refundable with \$10 purchase.)

lindco
model aircraft

Box 543FA Soquel, Ca. 95073

America's First Line of models...

CLEVELAND

World's Most Highly Priced Authentic Plans

FOR MODELS YOU'LL BE PROUD OF!
MODELS YOU'VE QUICKLY MADE ORDER SERVICE!

JUMBO SCALE BUFFS HAVE WE GOT 'EM!

FAMOUS OLD C-D PLANS RETURN!
1 1/2" SCALE GAS SIZE PLANS

Those "Terrific" Old C-D's Now in 1 1/2" Scale. Prices INCLUDE Patterns. Are Blow-Ups of 3/4" Jobs. Requiring Only Slight Beefing-Up.

G1 Great Lakes 271A	\$9.	G52 Mr. Mulligan	\$11.
G138 Spad XIII	\$9.	G60 Boeing P26-A	\$11.
G15 Fokker D7	\$12.	G64 Beech. C-17-B	\$12.
G188 Howard's Pete	\$12.	G72 Turner-Laird	\$9.
G218 C. Hawk P6-E	\$12.	G73 Superm. Spitfire	\$12.
G428 Howard's Ike	\$12.	G74 Messer. ME-109	\$12.
G48 Turner's W-W	\$9.	G75 Grum. Skyrocket	\$12.
G49 Hawk F11C-2	\$12.	G83 Grum. Wildcat	\$12.
G51 Comet Racer	\$12.	G129U Sopwith Pup	\$8.

MINIATURE TWIN-MOTOR C-D PLANS
COMPLETE with Patterns in 1/4" Scale (Take One-Half of 1/2" Scale Catalog Sizes) All Patterns Incl.

M35 Boeing 247	\$8.	M105 Wes. Whirlwind	\$6.
M45 Bomber B-10	\$8.	M115 D. Havoc A 20	\$9.
M51 Comet Racer	\$57.	M125 Mitchell B-25	\$10.
M75 Skyrocket XF5F-1	\$6.	M135 Marauder B-26	\$12.
M85 Lightning P-38	\$9.	M145 DH Mosquito	\$8.
M95 Hudson Bomb.	\$9.	M155 Bl. Widow P-61	\$12.
M100 Boeing B-17	\$13.	M165 Douglas DC-3	\$14.

NOW! MANY NEW MULTI-MOTOR DESIGNS.
Huge New Multi-Motor C-D "Dwarfies". These Plans Are Complete with Patterns. As Named Above. 1/4"=1 Ft. Scale (Or Divide SF Spans in Our Catalog By 3 and Multiply Answer By 2).

D45, \$10.	D51, \$6.	D75, \$8.	D85, \$12.	D95, \$14.
D100, \$17.	D105, \$7.	D115, \$12.	D125, \$15.	D135, \$16.
D145, \$12.	D155, \$16.	D165, \$18.		

MANY PATTERN SUPPLEMENT PLANS (PS) NOW AVAILABLE. SAME PRICE AS PRINTWOOD
SF 1/4" Scale Fans. You May Now Order P.S. Pattern Supplements for All Multi-Motor C-D Jobs. Prices Same As Printwood. Many others.

**THEY'RE ALL TALKING ABOUT IT!
THE NEW PICTORIAL C-D CATALOG**
Many More New Jobs Described in Our Pictorial Catalog in All Scales. (No Free Catalogs).

CATALOG: SEND 60¢ TODAY—3 YEARS \$1.10 DEDUCT 10¢ IF YOU SEND COIN OR CURRENCY
EXTRA CATALOG COPIES NOW 30¢ EACH

Most recently represented are WWII, WWII, Golden Era military and commercial, racers. Truly the serious design collector's paradise, for you'll not find such a gloriously splendid lot of designs anywhere else on earth! Just order a catalog and see for yourself. We guarantee satisfaction or your money refunded.

*Add 10% to ALL Plan and PS Orders, Except Catalogs.

CLEVELAND MODEL & SUPPLY CO.
103078 Detroit Since 1919 Cleveland, Ohio 44102

MODELER MAIL

(Continued from page 12)

actually loses 7.6 cents per copy for AMA members. Much greater income and profit is gained from newsstand copy sales, hobby shop sales, and direct subscriptions. Nearly all the present AMA members are former AAM readers. In other words, they now get their copies at cost and the magazine makes nothing on the sale. Furthermore, subscriptions and renewals of subscriptions especially are a magazine's best income-making source, even this is given up in selling copies to an association. In addition, the magazine bears all costs for production and printing the eight-page section. AMA supplies the raw copy, AAM typesets this copy, AMA does the layout, then AAM's art department prepares this for the printer. Of course there is some return for all this giving. AAM has built up the world's largest model magazine readership and good advertising support as a result.

AAM's relationship with the AMA came about because of my belief that a strong AMA is good for the entire industry. A strong industry is good for the magazine. Family ties and a long-time friendship with AMA were very much a part of the reasons. I know that these feelings will always be there.

Thank you again for your nice letter.

Ed Sweeney
Editor and Publisher, AAM

WING

PUSH RODS EXTRA LONG

THE BEST YOU CAN BUY!!

new...

FOR R/C PLANES, BOATS AND CARS. THESE 12" LONG PUSH RODS FIT ALL BRANDS OF LINKS, CLEVISSES AND RELATED ACCESSORIES. IDEAL FOR MECHANICAL RETRACTS. THE PRECISION ROLLED 2-56 THREAD IS A FULL 1" DEEP FOR MAXIMUM ADJUSTMENT. IDEAL HARDNESS. ROD DIA. IS .072 JUST A HAIR OVER 1/16" WHICH IS BEST FOR RIGIDITY. CAN BE BENT, SOLDERED OR CUT.

12" LONG
.072 DIA.
2-56 ROLLED THREAD

ITEM 210

SPECIAL OFFER !!

SEND THIS AD AND \$7.75 AND WE WILL SEND YOU 100 OF THE ABOVE RODS BULK WRAPPED.

PACKAGE OF EIGHT RODS \$1.39

WING MFG. BOX 33
CRYSTAL LAKE, ILL. 60014

VINTAGE R-C PLANS



SPINKS AKROMASTER

60" Wing Span, 2" Scale — Multi PLANS \$4.95
Vacuum Formed Plastic
Cowl, Wheel Pants & Canopy...\$9.50 (Both For — \$13.45)
A Fast, Acrobatic, Competition Airplane !!!



1930 KINNER FLEET BIPE
42" Wing Span, 1-1/2" Scale, Multi (Small Servos)
PLANS \$3.00

SEND 15¢ FOR 72" CATALOG TODAY TO —
DEALERS WELCOME
FAST POST PAID SERVICE

SID MORGAN
13157 Ormond, Belleville, Mich. 48111
ALSO AVAILABLE FROM... THUNDERBIRD Model Aircraft
870 Camstock Road,
Richmond, B. C.

Czech modeler seeks Pen Pal

I am a recent Ph.D. graduate of New York University. In preparing for publication of my first post-graduate essay, I have made the trans-oceanic acquaintance of a young Czech, Jaromir Jindrich, age 36, whose father is curator of the famed regional museum which is named in honor of their 19th-century kinsman with the redundant name of Jindrich Jindrich.

This is an extremely distinguished family, well-known to every Czech person, and perhaps the equivalent in Czechoslovakia of the American descendants of Benjamin Franklin. In addition to collecting and publishing virtually all the Czech folk songs, the patriarch Jindrich may also have aided the

GET TOP PERFORMANCE!

USE
VIBRA-TAK
Slide Rule Tach.

Check the RPM's of your motor accurately. Instantly know what peak your motor is operating... get top efficiency and smooth running power. Engine proven, VIBRA-TAK is a professional instrument built of polished, high stress aluminum. Carry it in your pocket or toolbox.

ONLY \$5
Including carrying case

Dealer inquires invited

Order from:
VERDELL INSTRUMENT SALES CO.

- CHECKS MOTOR SPEEDS
- INTERNAL COMBUSTION ENGINES
- ROTATING & VIBRATION EQUIP.
- GIVES DIRECT READINGS FROM 2000 TO 21000

P.O. BOX 212, EL CAJON, CALIF. 92020

DESIGNED FOR THE NEWCOMER TO R/C OR SPORT FLYER ●●●

Thor II



◆ Fully Custom Kit
◆ Accessories
◆ Full Size Plans
◆ Step-by-Step Instructions
◆ Finest Materials

terry PLANE, Inc. P.O. BOX 2429 ORCUTT, CA. 93454

\$28.50
FOB FACTORY
CA. RES. 5% SALES TAX

- WINGSPAN.....62"
- AREA...550 Sq INCHES
- ENGINE......15 to .29
- 1-2-3.....CHANNEL

INDEX TO ADVERTISERS

ACE R/C	80,81
AHM	72
Academy Products, Ltd.	92
Aero Precision	93
Aerotech Model Eng.	91
Aldrich, Geo.	77
Boyd, A.B.	78
Broz Entpr., Inc.	72
C&H Sales	73
CMI Quality Kits	61
Calgary Hobby Supply	73
Cannon Electronics	74
Cleveland Model & Supply Co.	94
Collectors Journal, The	83
D.A. Enterprises	88
Dembros Hobbies, Inc.	92
Du-Bro Products, Inc.	27
Dumas Products, Inc.	17
EK Products, Inc.	5
F.A.I. Model Supply	82
Fabra-Tex Corp.	86
Fagel Bros.	83
Fox, Mfg. Co.	86
GEM Models	78
Goldberg, Carl	11, 21
Graupner	34
Grish Bros.	93
Guillow, Paul K.	79
Hannan, W.C.	89
Hathaway, John	87
Heath Co.	77
Hobby Capitol	104, 105
Hobby Gallery	82
Hobby Helpers	91
Hobby Hideaway	93
Hobby Lobby	12, 13
Hobby Market	86
Hobby People	8, 9
Hobby Poxy	73
Hobby Shack	14, 15
Hobby World	78
Holman, Bob	83
Indy R/C Sales	69
Inky, Flite Boxes by	71
K&B Mfg.	33
K&S Engineering	75
Kayeff	57
Kraft Systems	Cover 3
Lindco	93
MnM Radiomodels	87
Micro-Craft Corp.	85
Midwest Model Products	51
Miniature Aircraft	82
Model Accessories Co.	41
Model Materials Co.	75
Model Rectifier Corp.	Cover 4
Morgan, Sid	94
National Hobby	92
Nelson Model Products	76
Northfield Precision	61
Octura Models	76
Pactra Ind.	79
Penford Plastics	82
Phil-leys	92
Pro-Line	87
RC Helicopters	95
RS Systems	91
Randy's Corner	79
Rocket City Specialties	74
Royal Electronics	82
Scientific	Cover 2, page 3
Sig Mfg. Co.	54, 55
Sonic-tronic, Inc.	69
Stanton Hobby Shop	89
Sterling Models	28, 29
Super Scale	92
Su-Pr-Line Products	77
Tatone Products	74
Tern Aero	76
Terry Plane, Inc.	94
Testors	75
Texas Models, Unltd.	72
Thermo-Jet Standard, Inc.	88
Tiny Tots	40
Top Flite Models	7
Tower Hobbies	26
Verdell	94
Vettco	78
Vortex Model Engineering	72
Williams Bros.	83
Wing Mfg. Co.	94
World Engines	70, 71
Ziac, C.A., Inc.	95

famous composer Peter Tchaikovsky in putting together his Symphony No. 6 (Pathétique), and it was so as to study this aspect that I first made contact with the Jindrichs.

After having provided me with extensive information on my topic, the younger Jindrich wanted me to help him in return. He has desired that I request a pen pal for him in your magazine, being a devoted fan of model aircraft. Is it possible that you could aid Mr. Jindrich in finding pen pals of your subscribers who represent the most competent devotees in America of the aspects of model aircraft in which he is most interest, i.e., CL Stunt and FF FAI Gliders, exchange of magazines, in English. His address is Machova 149, Domazlice, Czechoslovakia.

I myself am completely foreign to the topic of model aircraft, but I have noted down a few of the names of persons given in recent issues of your magazine who would seem to be promising candidates for becoming acquainted, through Mr. Jindrich, with the Czech scene: Gerry Geraghty (AMA 37258), of San Jose, California, who uses Czech models, and Danny Bartley of High Point, North Carolina, the national champion of CL (I don't know if this is the same as CL Stunt!). These are the only two people I have located in issues at the nearest library.

It would be quite nice if some assistance could be furnished to the younger Jindrich through your auspices.

Gene W. Marx
Jamaica, L.I., New York

LET'S GO UP!

LEARN TO FLY HELICOPTERS
WITH OUR AMERICAN BELL
JET RANGER



FOR THE MODELER WHO
WANTS THE BEST

The most complete helicopter kit on the market. Available at your dealer NOW! List price \$475
manufactured in the U.S.A. by

**RC HELICOPTERS,
INC.**
4550 White Plains Rd.
Bronx, New York 10470

212-324-3441
dealer inquiries invited

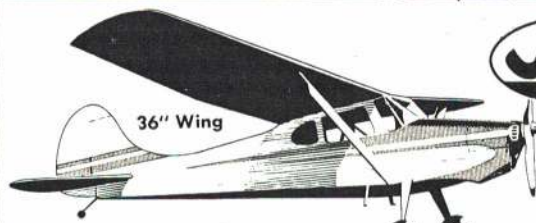

Bill Dean's **\$6⁹⁵** Kit #S-5
CESSNA "170"

More than a dozen contest wins to its credit. A detailed scale replica of the prototype, easily built from a well detailed set of plans. Fly with or without R/C Plastic cowl; die-cut balsa and ply parts; selected strip; gear formed; celluloid; decal set; shaped, tapered wing edges.

Free-Flight020 to .045



\$6⁹⁵
Kit #S-6
**PIPER
SUPER CRUISER**

All the scale realism you could hope for. The look, the feel, the performance of the full scale "Super Cruiser". Fly it with or without radio. Highly detailed plans, an attractive decal sheet; plastic cowl; formed gear. The balsa and ply parts are die-cut. Dowel; wire; covering.

Jetco RADIO
MODELS SCALE AIRCRAFT

FREE-FLIGHT, RADIO CONTROL
Radio Control045 to .074



JETEX
16" Wingspan **\$1¹⁹** Kit #J-2
"CUTLASS"

For Jetex "50" Power . . . Catapult . . .



22" Wingspan **\$1¹⁹**
Kit #J-3
"JET 50"

Fly it today. It assembles that fast!!! High thrust prevents looping; die-cuts; clay ballast; hardwood fuselage. Flies!

BEST IN KIT DESIGN

Jetco

C. A. ZAIC CO. INC., 883 LEXINGTON AVENUE, BROOKLYN, NEW YORK 11221

See your dealer today for these and other fine Jetco kits of all types. If no dealer is convenient, send us \$50⁺ additional, and mail orders will be filled direct.

Editor:
Carl Wheelley

MODEL AVIATION

Official magazine

A.M.A. NEWS



Academy of Model Aeronautics • 806 Fifteenth Street N.W., Washington, DC 20005

INTERESTED IN JOINING A.M.A.? Over 46,000 did in 1972. Details may be had by requesting FREE BROCHURE from above address.

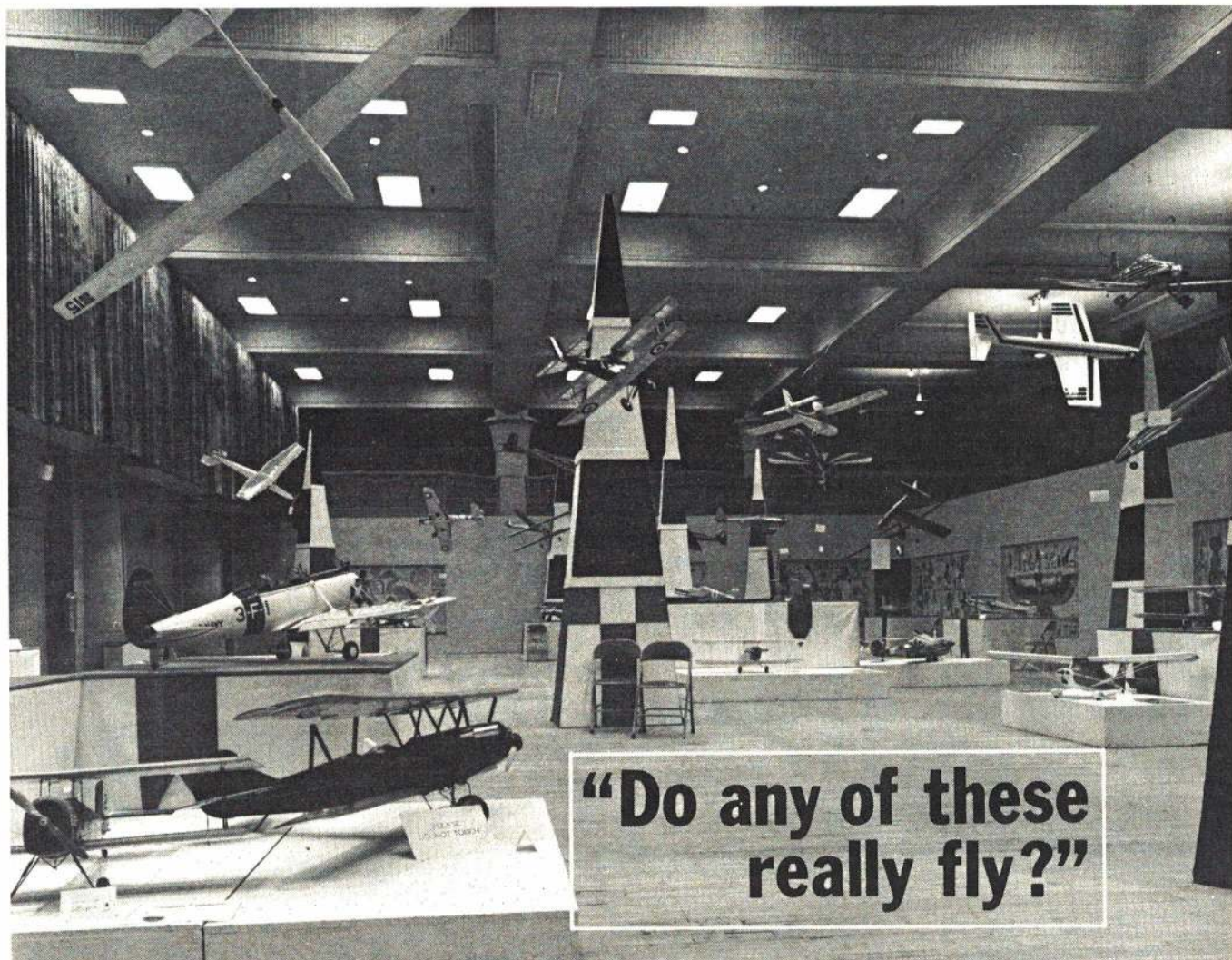

Winter is an excellent time for clubs and club members to engage in modeling promotions on a local basis. A tie-in with a shopping center or a large store yields obvious benefits for both the commercial concerns and the area's modelers. Read the John Wanamaker Contest report by AMA Public Relations Director Bob Lopshire for tips on how to do it plus a few pitfalls to avoid.

For twelve days the public flowed through the department store auditorium, some quickly, most slowly, some silently studying, others making excited noises at each stop—and almost all had questions, the most often asked being, “Do any of these really fly?”

The occasion was John Wanamaker's “Concours d'Elegance For Remote Control Aircraft,” and the object of all the study, excited conversation, and questions were the fifty-three Radio Control planes on display in a unique contest designed to acquaint the

public with RC activity on a firsthand basis, as well as provide a mid-winter activity for clubs in the Philadelphia area.

Along with the public asking if any of the planes really flew, the next most asked question was, “How much do they cost?” Upon hearing that simple outfits could be purchased for roughly \$70, and that the all-out rigs went for around \$500, including the kit for the plane, many grandparents decided RC planes were THE thing for their grandchildren (!) and many wives decided that now they knew what to get old sourpuss for Christmas next year.



Most people wanted to know, once assured that the planes did indeed fly, where they could see them fly, and while all were carefully given directions, one family posed a bit of a problem. They were from Michigan, far from downtown Philadelphia. This one was soon resolved, though, when they said that they lived in the Dearborn area. They were given the name of an AMA officer (Jack Josaitis) who runs a hobby shop in that area.

The questions went on to include technical ones by engineers, and some truly original ones by little old ladies who wanted to know how the planes could fly the Atlantic and where they landed on the other side, where the pilot sat, and declarations that no wonder the airmail service is so bad what with so little room to carry letters. One woman said that she had seen the things flying, and now that she knew they were radio controlled, she better understood why they had those two wires going to them from the ground: they were to carry the electricity for the radio. . .!

Of great puzzlement to the uninitiated was the difference between building from plans and building from a kit. To them, a kit had to be something like a Revell or Monogram plastic model kit—all the parts finished and ready to quickly glue together. Even with one plane sitting on a stand sans "clothing" so that all could see the construction, most people were convinced that it was some sort of freak, and that all the other planes were a magic combination of plastic prefabrication. No amount of explanation could convince many that such was not the case, even when taken to ships sporting a transparent MonoKote skin where the balsa frame shone bravely through. The perfection of the builders had them baffled, and several boys, out to impress their girl friends, assured their darlings that the planes were all made in a factory in Japan.

A film of ABC's Wide World of Sports TV coverage of the 1967 Nats in California was shown daily to create further interest in the show, and after watching the Pylon Races in the film, the audiences went back to inspecting the display with renewed vigor. By Golly! The things *do* fly!

There were eight categories of competition, with Wanamaker awarding trophies to



Scale and semi-scale airplanes are the types that the general spectator can identify with and appreciate most at exhibitions. Model shown is the 1938 Waco entered in the Wanamaker Contest by Adam Schaeffer, Jr., of the AMA chartered Valley Forge Signal Seekers.

the first place winners and AMA giving certificates of award to first through third places. The largest plane award was won by Dick Cannavvo of the Philadelphia Rangers with a Custom Cavalier. Smallest was easily taken by Dan McClain of the Valley Forge Signal Seekers with his 6" (yes, INCH) span Gnat biplane. Pattern was won by Bud Phillips of the Rangers with his Twister (He also took third place with his Grouper). Sport category was won by Rudy Black of the Delaware RC Club with an original make-believe mail plane (not much room for letters though), Pylon by Bill Moffa of the Philadelphia Rangers with a Minnow, Sailplane by Helmut Hess of the Bucks Country RC Club with a Windward. Howie O'Keefe's P-51, "Miss America," took first place in Scale for Henry Haffke of the Misguided Missiles of New Jersey, and no one had doubts when Dick Francis won first place in the Most Unusual Flying Object category with his "Flying Blind" an eight-winged plane that was evidently Venetian in origin (Dick wisely supplied in-flight photos that turned off all the doubting Thomases).

Among the fifty-three planes entered, almost every category and type was represented in the turnout, including the big show stopper for pilots, engineers, and the like. . . Carl Canter's Huey Cobra. While Carl was a nervous wreck for the entire period of the show, figuring that someone would get the complex gadget completely out of whack, it went untouched. In spite of the confusion on the part of some as to whether the planes were made in a factory in Japan or not, the public did respect the fact that, however made, there was a lot of work involved. A few kids, as expected, did touch, but for the most part, even the youngsters respected the work and love involved in each creation and kept their hands where they were told. . . in their pockets.

At a relatively slow point in the crowd flow, a German couple came into the large auditorium that housed the show and proceeded to slowly study each entry. They were quite serious and meditative, exchanging comments from time to time about various planes

Continued on page 102



Above: Another view of the display in the Wanamaker Auditorium. A combination of hanging and platform displays provided good visibility of the airplanes. Right: 1931 Curtiss-Wright Junior took 2nd place in the Concours d'Elegance judging for Scale. Builder is Graham Lomax of the Delaware Radio Control Club of Wilmington.





NEWS bits

Magazines & Membership

RC Modeler magazine has attacked the decisions of AMA's Executive Council (see Dec. '72 AAM-AMA News Section) relating to magazines purchased for AMA members and the effect upon the 1973 AMA dues increase. AMA chartered clubs got the other side of the story in recent mailings.

If you belong to a chartered club, be sure to ask your officers to read this informative piece or to make it available for individual members to read.

If you're not a club member and want to know the whole magazine story, send a pre-addressed, stamped (8 cent) return envelope to AMA HQ, and ask for a reprint of "The Magazine Controversy."

Meanwhile, membership renewals for 1973 are pouring into AMA headquarters at a rate equal to last year's record-breaking pace.

Indoor Electrics

No more "slow" winter months for the AMA chartered Lake Erie Gas Model Club

(Ohio) whose members have re-discovered electric power for models flown indoors from a pylon. Fishing line is used to tether the models, with power from an HO model railroad power pack being transmitted through light-weight wires. At the pylon a sliding brush arrangement is used for coupling the power pack to the wires; at the airplane end all the club members have standard miniature two prong connectors—for interchangeability of models.

Most club members have been using an inexpensive slot car motor which is said to provide power at least comarable to that of an .020 engine, but suitable for indoor flying. The motors weigh just under two ounces. Thus mounting must be near the center-of-gravity if proper balance is to be maintained.

These electric planes may be flown from a tether as short as 6 feet, but a much longer tether may be used if more space is available. According to LEGMC Secretary Dick Woodward (AMA 36375) whose words appeared in the newsletter of the Cleveland Aeromodel Society, these models are also ideal for public displays.

Christmas Model Gifts

That time of year when parents and grandparents are apt to be giving ready-built airplanes to youngsters is right around the corner, and many AMA chartered clubs are already preparing for it. The idea, which has much appeal to the press and thereby obtains good publicity for the club and modeling in general, is for a club to conduct a clinic for those boys and girls who are given ready-built CL models for Christmas—to teach them how to start and operate the engines and how to fly the airplanes.

But don't expect the publicity to come without some work. Let your plans be known to the newspapers, radio and TV stations, and also post signs at hobby shops and any of the other stores selling this kind of model.

Among the clubs hosting such clinics last Christmas was the AMA chartered Tulsa Glue Dobbbers. Twenty-five "pupils" registered for their two-hour course, the majority in the 9-12 age bracket. Each had at least one flight, and some had as many as three—interspersed with club members flying their own aircraft to show and to interest the newcomers in more advanced airplanes.

Two Tulsa papers had extensive articles concerning the demonstration a few days before the date, and one of the papers had a nice pictorial follow-up afterwards. Two TV stations showed flights and interviews that evening. Great PR!

Pete Hendricks' Stearman PT-17 Sport Scale model is built from Sterling kit, ST power.



Left: Christmas food boxes for needy families is a community project of the Sky Devils CL Club of Kansas City. Walt Garret photo. Below: On behalf of the GSLMA Bob Underwood (R) presented a token of thanks to G.A. Buder, Jr., whose family donated land for the St. Louis Buder Park RC and CL flying field.

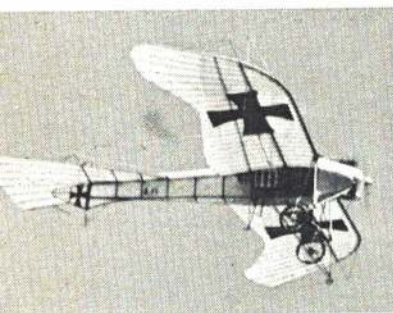
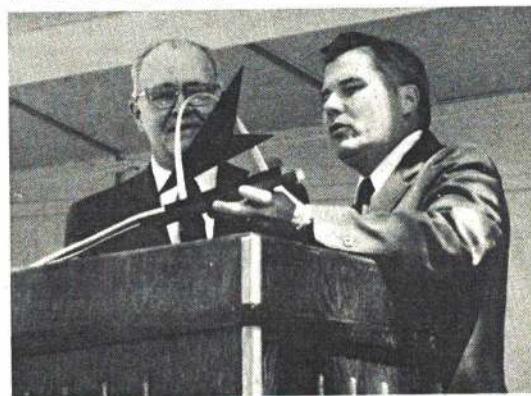

Left: Winner of the FAI class of the AMA sanctioned West Coast RC Scale Championships last August was Mel Ford's Taube. Bird-like airplane model has exceptionally slow flight. Submitted by M.B. Groves. Middle: Dan Frey, age 15, obviously likes the profile Me. 109—for CL Stunt and Slow Combat. He's a member of the Circle Airs Club of Wauwatosa, Wisc. Submitted by Donald Hoover. Right: Contest Director Bud Tenny presents awards to Junior Easy B Indoor event winners of the 1972 Spring Jubilee Meet at Dallas. Shown (L-R) are Tenny; Jimmy Clem, Dallas; Mark Kilgo, Garland; Ian Yanagisawa, Dallas.



Congratulations to Our U.S. Air-Modeling Teams

Saturday night banquet at the RC Masters, AMA President John Clemens at the rostrum preparatory to presenting the President's Award to the host Rocket City Radio Controllers. Seated at the head table (L-R): Huntsville Mayor Joe Davis, Mrs. Gary Martin, Gary Martin, Maynard Hill, John Patton. Martin is president of the Rocket City Club. Hill and Patton, together with Tom Rankin, formed the Competition Jury.



PRESIDENT'S MEMO

Our entire AMA membership and the whole United States should be bursting with pride over the showing our American modelers have made in World Championship events this year. We sent a Control Line team to Finland, a Scale model team to France and an Indoor team to England—all for World Championships competition. Since the results of these meets have been reported elsewhere I will simply say that I would, as president of AMA, like to thank and congratulate the members of those teams and their managers for representing the AMA membership and the United States so ably and honorably. It is sure a good feeling to be on the same "46,000-member team" with these folks! Now to project forward.

SOUTHERN HOSPITALITY—and the RC MASTERS TEAM SELECTION. We went to Huntsville, Alabama, to watch 32 of the world's finest Radio Control flyers compete for a place on the team of three who will represent AMA and the United States in the Radio Control World Championships to be held NEXT YEAR in Italy. In all of AMA's activities around the country during AMA's many years, I don't think there has ever been such warm welcoming and fine hospitality as we found in the heart of the South there in Huntsville! The host club, the Rocket City Radio Controllers, went "all-out". My first clue to this was when the plane that Don Downing and I were on arrived two-and-a-half hours late—with the airport over twenty miles from Huntsville and the plane that far off schedule, we were smilingly met at the airport gate by a Rocket City Club member! He drove us to the headquarters motel after gathering up our baggage—all but Don's competition plane, which had been lost in the flight delay.

Accommodations were excellent and the prices right. The flying site was ideal, and the meet itself was beautifully run. The banquet on Saturday night at the Sheraton Motor Inn was delightful, and lent a dignity to air-mod-

eling that we are eagerly seeking. Mayor Joe Davis of Huntsville was on hand to extend the city's welcome to those of us who were truly from all over the entire United States. I personally had the pleasure of presenting my own tribute, the President's Award, to the Rocket City Radio Controllers through their president, Gary Martin. Gary asked Mayor Davis for the trophy to be placed in the Huntsville City Hall.

As for the flying in the Masters, well it was simply the world's best flyers picking their own team of three special flyers to represent the United States. Competition went "right down to the wire," and I think the resulting team is excellent. Jim Whitley's previous team experience and precision should be a great aid to the other two "real comers," Norm Page and Jim Martin. I am just full of pride and excitement over our new team!

Summarizing the Masters, my congratulations and best wishes on behalf of AMA's 46,000 members to the new U.S. Pattern RC Team! And our congratulations to the Rocket City RC Modelers for having so effectively called the country's attention to air-modeling in the Southeast of these United States.

The RC Masters was the best example yet of teamwork between AMA as a national organization and one of our chartered clubs. AMA HQ and AMA-FAI officers, particularly Team Program Administrator Tom Rankin (now team manager), worked for many months in advance with Rocket City Club officials. Altogether about 15 AMA officials, including 10 judges from all parts of the U.S., joined in this big effort to produce a miniature version of a world championships. All involved deserve a big hand for helping to make this a most professional event. Our thanks also to Huntsville's Mayor Davis for hosting those of us from the rest of the country. As Jim Kirkland said to me, "How's it feel to be in God's country?"

A PLEASANT SUBJECT FOR A FUTURE "PRESIDENT'S MEMO." It is a beautiful thing to see more and more of the wives and families entering into modeling and AMA's activities. It is especially handsome to

see the wives taking over many of the official chores and offices of the model clubs, and working in the operation of many of the contests. We even have a bunch of ladies as official AMA Contest Directors. More about this later, you darlings!

AMA DUES INCREASE. Considering that we are getting some letters of deep protest to the announced AMA dues increase, I thought it might be appropriate to repeat my remarks from the September AMA Monthly Mailing, which goes to chartered clubs. The dues increase was voted by the Executive Council (which included a voting representative from YOUR DISTRICT) after l-o-n-g and searching consideration. The increase is actually overdue by about two years, considering the continual increases in simple cost-of-operation that AMA has faced. The darned machine simply won't run without money! AMA is being forced to face ever-increasing responsibilities, and is working hard to provide more services and protections. And we simply can't expect quality people to work in our office, and responsible companies (insurance, attorneys, and so forth) to serve us without our meeting the universally increased costs that they face.

While reading the letters of protest (comparatively few actually) about the dues increase, I am wondering if those same people have written indignant letters to their grocer, the landlord, the auto manufacturers, the clothing manufacturers, the airlines, Disneyland, Six Flags, the magazines, and the local movie when they raised their prices! The dues asked are really a small amount to support all the pleasures and privileges of organized modeling; so come on, let's ante in and quit griping. Remember that even postage stamps have gone up in price SEVERAL TIMES since our last dues raise, and AMA uses A BUNCH OF STAMPS!

BE A PART OF THE WORLD'S LARGEST SPORTING AVIATION ORGANIZATION, THE ACADEMY OF MODEL AERONAUTICS.

*John E. Clemens
AMA President*



RC MASTERS

Thirty-two of the nation's best RC Pattern flyers assembled in Huntsville, Ala., last September 22-24 for the RC Masters Team Selection Tournament which was organized by the AMA, sponsored by members of the RC industry and hosted by the AMA chartered Rocket City Radio Controllers. At stake were the three highly prized positions on the U.S. team for the 1973 RC Aerobatic World Championships planned for Gorizia, Italy, next September.

Last month's "AMA News Extra", page 103, gave the basic placing information for all the entrants. The pictures this month are of the winners and some of the others who worked hard to earn the privilege of competing.

Some have said that of all the RC contests held in the U.S., including the Nats, the most seriously attended and contested was this year's RC Masters. And it was a great contest, an example for future major modeling events to shoot for in quality. A great team has been chosen to represent the U.S.!



Above: AMA film producer Jay Gerber records flight by Don Coleman and his Sweetater—16th place. Below: Two Rocket City RC'ers man the instant-relay scoreboards, an innovation by Jay Gerber first tried with great success at this year's Nats.



Above: the U.S. 1973 RC Aerobatic World Championships team. L-R: Jim Whitley, Team Manager Tom Rankin, Norm Page and Jim Martin. If you guessed that their respective planes are the Daddy Rabbit, Mach 1 and Ban-shee, you're right! Rankin, who was named to the team manager post in accordance with procedures described in the July 1972 AAM, served as administrator of both the current and previous RC team programs.

Left: William Richards, 18, (R) checks throttle in preparation for official flight. His dad holds the Mach 1 as Huntsville official checks time. He placed 20th.



Jim Kirkland cranks up under watchful eye of official who has started time. Kirkland's own design plane is named Nutcracker.

AMA Renewal Time

DECEMBER 15 IS CRITICAL DEADLINE TO RENEW AMA MEMBERSHIP WITHOUT LOSING SERVICE, MAGAZINES.

Owing to the publication lead time, the very least to be expected for members whose renewal applications are received by AMA HQ after this time is that their March American Aircraft Modeler will reach them late. This is because the March issue is mailed in January, and the address tapes of AMA members are prepared for the publisher during December.

Those who wait until after the critical deadline will have 1973 subscriptions initiated from scratch—just like new members, with a six week lag in magazine renewal service.

The February AAM, which is printed and mailed in December, is the last magazine to be mailed to 1972 AMA members—all 1972 memberships expire December 31, 1972.

Renewal notices were mailed to 1972 members in early October. Any AMA member

who has not received his 1973 bill for dues by the time this issue reaches newsstands should notify AMA HQ immediately.

Thinking of joining AMA for the first time? Right now (by December 15) is the best time to do so because, by joining early you will receive maximum value—12 issues of American Aircraft Modeler plus all AMA benefits during each month of 1973. Use the handy form on page 103.

New for '73

Two very useful additions to the AMA membership package this year are a full color vinyl AMA Bumper Sticker/Safety Code and a collection of more than 20 coupons for free and special introductory reduced rate offers from model industry firms—both exclusively for AMA members.

The special coupon offer was conceived by AMA HQ as a cooperative effort with the industry to make it easier for AMA members to sample sponsors' products or to obtain special benefits and services. The effort recognizes AMA members as the leaders among all modelers. The total value offered amounts to more than \$30 in savings!



Above: Alan Dupler (L) placed 13th with his own design Trion. Below: Two-time World Champ Doc Brooke placed 9th.



Above: Lew Penrod, assisted by brother Dick, flew a Tiger Tail to 17th. Left: Another Tiger Tail placed Steve Ellison (R) 5th, just short of team—assisted by Whitley.



Above: Painting by AMA PR Director Bob Lopshire (ctr.) for Masters Program cover was raffled off to help contest expenses (it about broke even). Don Downing was the lucky winner—presentation by Mrs. Don Bowman.

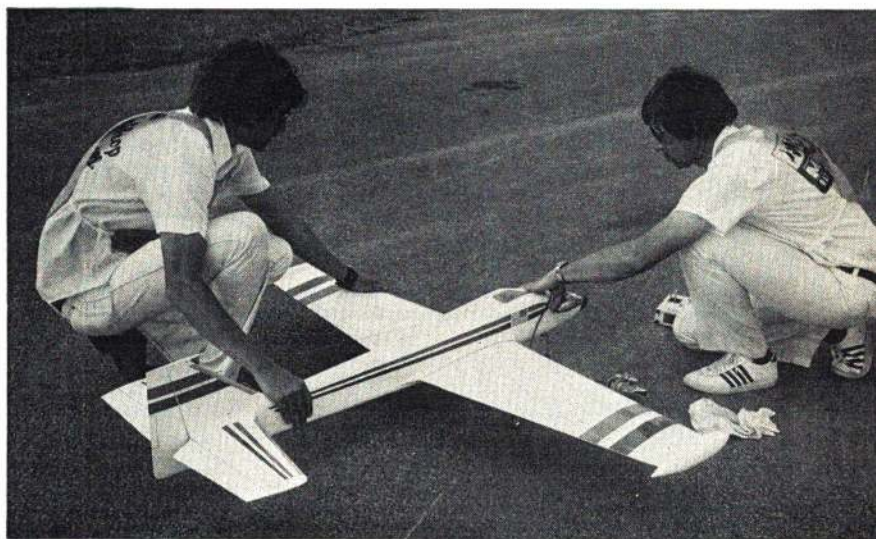

Right: Jerry Worth, assisted by Mike Mueller, preps for flight—29th place. Pantera X-9 won Toledo Design 1st.



FAA Advisory Circular and AMA Insurance

Publication of the Federal Aviation Administration Model Aircraft Operating Standards in AAM (November, page 49) and in other magazines, plus direct distribution to all AMA members, has raised the question of effect on AMA insurance. In particular, members want to know if AMA insurance remains in force should a model happen to fly higher than 400 feet—the maximum height specified in the circular.

The answer is that failure to follow the advice of the FAA circular will not invalidate AMA liability insurance.

Does this mean that there is no need to follow the FAA standards? Not at all! In fact it is absolutely essential that we each do everything within our power to conduct our operations so as to eliminate any dangerous situations between models and full scale aircraft. This must be done to assure the future well being of model flying activities.

The AMA recommendation is to follow the FAA Model Aircraft Operating Standards, including the maximum flight altitude, whenever possible and especially when flying models in an area where nearby flight of full-scale aircraft might be expected. In such a situation, models should not be operated unless the flyer has someone else with him for the sole purpose of watching for full-scale aircraft and supervising the flying so as to prevent accident possibilities. In addition in such situations, if you are expecting to fly a model higher than 400 feet, it is strongly recommended that you first notify the nearest FAA airport control tower or air route traffic control center.

WANAMAKER SHOW

Continued from page 97

and evidently enjoying the display as if in a museum of art... until they reached an Eindecker entered by a youngster in a club to the north of Philadelphia. The couple went into hysterics and finally, when the woman could catch her breath, she approached the AMA member on duty to explain that the German WW I plane had a string of victory flags painted on the side of his plane... all WW II GERMAN flags. Believe it or not, they were the ONLY people to spot this, and the show was seen by MANY modelers! (Heinrich, de uter guys duzzn't like dat you fly mit dem." "Vy nodi? I Godt bad bredt or sumsing?" Nein dumkopf! You godt bad aim!")

A great number of truly outstanding planes turned out for the show, such as Bob Karlsson's PT-19, Rudy Black's E-2, an ersatz mail plane that looked like it was a real Scale effort, Don Mill's Gere Sport that had metal-work beyond belief, (it lost out in Scale because of a covering material that Don is still cursing... it sagged miserably just before judging, as did some of the other "easy-to-use materials". Matter of fact, most of the planes covered with the "miracle" coverings were a sad mess by the end of the show, due to the cold display auditorium. Back to the ironing board...).

So how did all this come to be? It all began as a two-fold idea, a promotion for the store of course, but one originally suggested by AMA as a promotion for the then coming RC World Championships in Doylestown, Pa., September of 1971. The store management decided that with other promotions running for the Championships, they would like to do something entirely different, and since they had wanted an aviation display for years, they would make this into something special. While material was sent out that tied the contest to the Championships, new material sent out updated the event to February of 1972 as a month-long contest. As with all large organizations, though, communications got a bit snarled, and the final outcome was a shorter than announced contest time of two weeks of display to the public. This shifting of times caused considerable confusion to the clubs invited, mainly because clubs meet but once a month, and club secretaries don't always pass on all the nitty-gritty they receive.

Because it was decided to include all clubs within a 100-mile radius of Philadelphia, and roughly 175 clubs were involved in the invitations, each club was limited to a maximum of five entries; this was based on the idea that if half the invited participated, there would be close to 500 planes for the show! Wanamaker has a large auditorium, but 500 would more than fill it. That one-tenth of the expected entries arrived was a bit disappointing, but only to AMA and Wanamakers. The public was thrilled and RC made a giant step forward in the Philadelphia area.

Why the low turnout? Several reasons. Apathy on the part of many clubs which failed to see the value of "selling" RC to the general public for their own good, the hard-to-reach center city location of John Wanamakers' main store, the fear of some clubs that their efforts would not be good enough, the skimpy prize list. Some clubs not receiving the mailed-out material as sent by Wanamaker and AMA due to the changing of club officers at year's end, and finally, the threat of a snow storm that hung over the area on the day the planes were due for delivery to the store.

Another factor was learned from hindsight: the area of participation sought was too large, combined with an unnecessary restriction on the number of entries per club. It would have been better to draw from only the city and its immediate suburbs and to contact all individual AMA members in the area rather than just the clubs. Another lesson: adequate insurance must be provided by the store—some excellent models were not entered because the builders were not willing to risk damage by the public. No damage occurred, but a minimum of \$1,000 insurance per entry would relieve anxieties and attract more top class models. Along the same line, good security is needed in such a project—regular policing of the display area should be provided to protect the models.

Is the program still a good idea? Yes, definitely! Designed as a pilot program to be offered to clubs all over the U.S., lessons were learned to make the program better in all respects. Originally only an idea, the idea has now become a tangible event that any club or group of clubs can put in motion by using the guidelines established in this test run. These guidelines will be available to any interested

group by the time this appears, and for any club wishing to help themselves by way of public promotion, this method offers one of the better means of accomplishing it. This type of static display allows the public to get close, ask questions, and to become involved emotionally in something they would otherwise never see... unless their travels happened to take them by a flying field... a rarity in most cases.

A key PR aspect of such a display project is that, when done with a large department store or shopping center, good publicity can be expected. Newspaper, TV and radio ads resulted from the Wanamaker program. Such stores also have publicity and display departments for dressing up and promoting the display—many signs, banners, photos and other eye-catching aids are available, including big outdoor signs in most places.

As a result of the Wanamaker project, AMA recommends suburban shopping centers as the best source of display sponsorship. Such centers usually have excellent (and free) parking—a vital ingredient for good public attendance—which simplifies delivery and pick-up of models. Also, instead of depending upon a single store sponsor, the entire center can participate, with publicity signs in all stores.

Aroused your interest? Like to try it in your area? If so, drop a line to: Academy of Model Aeronautics, Wanamaker Contest, 806 Fifteenth Street, N.W., Washington, D.C. 20005.

Contest Calendar

Official Sanctioned Contests of the Academy of Model Aeronautics

DEC. 3—TUCSON, ARIZ. (A) Winter Snow Fest. Site: Rodeo Park. T. Snow CD, 237 E. Roger Rd., Tucson, Ariz. 85705. Sponsor: Cholla Choppers Model Airplane Club.

DEC. 3—VAN NUYS, CALIF. N.A.R. Flightmasters 4th Annual "Jumbo Rubber Scale" Meet. Site: Van Nuys Basin, C. Hatrak CD, 3825 W. 144th St., Hawthorne, Calif. 90250. Sponsor: N.A.R. Flightmasters.

DEC. 10—MIAMI, FLA. (AA) Dade Parks & Recreation Dept. Indoor (Cat. I) Contest. Site: Youth Fair Exhibit Hall. R. Myers CD, 3935 SW 125th Ave., Miami, Fla. 33165. Sponsor: M.I.A.M.A. Club.

DEC. 10—ELSINORE, CALIF. (A) Thermal Thumbers Wakefield FF Annual Meet. Site: Lake Elsinore. M. Keville CD, 5407 Pimenta Ave., Lakewood, Calif. 90713. Sponsor: Thermal Thumbers.

DEC. 29-31—JACKSONVILLE, FLA. (AAA) 19th King Orange FF (Cat. II) & CL Internationals. Site: Imeson Airport. J. Wagner CD, 283 E. 8th St., Hialeah, Fla. 33010. Sponsor: Jacksonville Free Flight Team.

DEC. 31—FRESNO, CALIF. (A) Fresno Monthly FF (Cat. I) Meet. Site: Near Kerman. F. Ginder, Jr. CD, 5740 E. Ashlan Ave., Fresno, Calif. 93727. Sponsor: Fresno Gas Model Club.

DEC. 29-31—JAN. 1—WINTER PARK, FLA. (AA) Tangerine International RC Championships. Site: R.C.A.C.F. Field. W. Schoonard CD, 2080 Sharon Dr., Winter Park, Fla. 32789. Sponsor: Remote Control Assn. of Central Fla.

APRIL 28-29—FT. WORTH, TEX. (AA) 3rd Annual "Lone Star RC Airobotic Convention". Site: Benbrook Lake. L. Stanfield CD, 1813 Montclair, Ft. Worth, Tex. 76103.

JUNE 2-3—BATON ROUGE, LA. (AA) "Cajun Classic" Baton Rouge 12th Annual RC Meet. Site: Kleinpeter Field. H. Roberts CD, 9243 Hampton Way, Baton Rouge, La. 70814.



**OVER 46,000 JOINED IN 1972
7,000 more than the year before !**

YOU CAN TOO!

AMA* MEMBERSHIP OFFERS:

- liability insurance • special discounts • official rules manual • competition privileges
magazine subscription • exclusive decals • aid to air youth • national recognition

Subscription to American Aircraft Modeler is included with AMA adult membership—includes AMA News. Members under 19 can purchase the magazine at a special, low, AMA rate.

Discounts on special items stocked by AMA Supply & Service Section—books, magazines, pins, decals, etc.

Special Help for Youth Members: Membership fee, with full competition privileges, eligibility for AMA scholarships, only \$3.00 for either Juniors (up to 15) or Seniors (15 thru 18). (Does not include magazine subscription—cost with magazine subscription only \$7.50.)

Official Rule Book included with all AMA memberships. This manual details the specifications by which different types of models are built and flown and clarifies most of the specialized model aviation terms—a real aid to understanding model magazine reporting.

*The Academy of Model Aeronautics—a non-profit organization, organized in 1936; guided by regional officers elected from among the membership. National headquarters is in Washington, D.C. AMA members have privileges in other organizations: National Miniature Pylon Racing Association (NMPRA) open only to AMA members. Membership in the Nat'l Free Flight Society (NFFS) is \$1.00 less to AMA members. All AMA members are automatically part of the National Aeronautic Association (NAA) and the Federation Aeronautique Internationale (FAI); may become voting members of NAA—with other special benefits—for half price, and may obtain an FAI sporting license for international competition.

Liability Insurance is included with all AMA memberships. Bought separately, this insurance would cost more than the adult AMA membership fee. Coverage is for \$300,000!

Special Offer Coupons—New for 1973, a combination of more than 20 free and special introductory reduced rate offers from model industry firms included with all AMA memberships—altogether worth more than \$30 in savings!

Super Decal Sheets—a big 9" x 12" sheet contains AMA wings and FAI emblems in many sizes; another 7½" x 9" vinyl self-stick decal contains an attractive bumper sticker and also the official AMA Safety Code.

Competition Privileges: All AMA members are licensed to enter the National Model Airplane Championships and all other non-restricted meets (over 500 each year—fun-flies, local, state and regional meets, and record trials); to establish national and international records; to compete on U.S. teams in World Championships (two held per year).

TO JOIN AMA USE THE FORM BELOW: AMA membership ends each year on December 31, regardless of the date a membership application is received. Late-year membership policy is as follows: those who apply between August 1 and September 30 pay full one year rate, but will receive half-year credit toward the next year's membership—they must, however, use this credit by July 1 of the next year; those who apply between October 1 and December 31 pay full one year rate and receive full membership for the following year, plus whatever days of membership remain in year of application.

APPLICATION—1973 AMA MEMBERSHIP

Academy of Model Aeronautics, 806 Fifteenth St., N.W., Wash. D.C. 20005

FOR THOSE 19 OR OVER BY JULY 1, 1973

Includes all membership and competition privileges—and American Aircraft Modeler subscription.

Open\$15.00

New Renewal (number _____)

FOR THOSE NOT 19 BY JULY 1, 1973—Check One Only!

FILL IN DATE OF BIRTH Mo _____ Day _____ Yr _____

JUNIOR OR SENIOR—No magazine\$3.00
Includes all membership and competition privileges—except American Aircraft Modeler subscription.

SAME AS ABOVE—with subscription\$7.50

MAIN INTEREST (Check only one): CL FF RC INDOOR SCALE ALL

1973 Membership expires Dec. 31, 1973

Name _____

HQ use only

Address _____

City, State _____ Zip _____

21st ANNIVERSARY SALE

Kits and Motors

- 101 Joy Jenny Bipe. \$49.95 Net \$37.00
- 102 Mooney Chaparel. \$55.00 Sale. \$38.00
- 103 Midwest. Ez Juan Sail Plane. Net \$20.00
- 104 Midwest Snorky Trainer. Net \$8.00
- 105 Piper J 3 72" kit. Sig Mfg. Co. 2" scale or clipped wing cub. \$23.95. Sale \$18.44
- 106 Stirling P-51 Mustang. or Spitfire \$39.95. Net \$30.00
- 107 Giffow P-47D. \$11.95 kit. Sale \$8.00
- 108 Midwest Ez Juan 9" Glider for RC. Net \$20.00
- 109 Midwest Cessna Cardinal. \$21.95. \$15.55
- 110 Dee Bee Piranna 50" for 35RC. \$41.95. Sale \$28.88
- 111. Dee Bee Super Eyeball \$59.95 Sale \$39.95
- 112 Mirage 42. \$41.95 Sale \$28.88
- 113 Aero Precision. AT 6. 50" wing. \$39.95. Sale \$28.88
- 114 Super Eyeball. Dee Bee. \$59.95. Net \$39.95
- 115 Dee Bee Cardinale. \$39.95 \$30.00
- 116 Midwest Trisquire. \$17.95 Sale \$11.11
- 117 ST 23RC. This is an engine in great demand. \$23.98. While the supply lasts. Sale \$20.00
- 118 ST 15FAI speed with spinner. \$20.00
- 119 McCoy 19RC. \$14.95. Net to you. \$10.00.
- 120 OS 35RC. or OS 30RC. stacked to ceiling. \$24.50 Sale \$16.66
- 121. K&B 40RC. rear and front rotary. \$37.00. Net. \$25.00
- 122 - Black Ross 60RC. twin. \$145.00. Sale. \$125.00
- 123 - Webra 40RC. Blackhead. \$63.40. Sale. \$42.22
- 124 Cox Baby Bee. Net. \$4.00
- 125 42" Ringmaster & Fox 35. Sale. \$17.50
- 126 Midwest Flea Fli 10. \$24.95. Net. \$16.66
- 127 Merco 49RC. \$44.95. Sale. \$33.33
- 128 Cox Medalion. 15 RC. Sale. \$14.00
- 129 Cox Medalion 09RC. Sale. \$12.00
- 130 Cox Tee Dee 051. Sale. \$9.00
- 131 Cox Pee Wee 020RC. Sale. \$7.00
- 132 Cox Tee Dee 049. Sale. \$9.00
- 133 Cox Tee Dee 010. Sale. \$9.00
- 134 Fox 1/4 35. \$16.95. You pay: \$12.
- 135 Fledgling. tri gear top wing trainer for 23 & up. 56" wing span. \$24.95. Yours for \$16.66
- 136 Groupner Middle Stick Net. \$39.00
- 137 Hegi Burda Piper 72" Net. \$40.00
- 138 Pilot Skywagon. \$49.98 Net. \$37.00
- 139 Dee Bee Eyeball. \$55.00 Net. \$35.00
- 140 Stanford Super Midget. Net. \$29.00
- 138 Dubro Cherokee Arrow. list \$39.95. Sale \$27.00
- 139 T 2 Glider. superior models. \$29.95. Sale \$22.22
- 140 Dubro Aero Commander. \$39.95 kit. Sale \$24.00
- 141 VK Nieuport Bipe. \$44.95. Sale \$28.88
- 142 VK Fokker Triplane. \$47.50. Sale \$34.00
- 143 Lancer Kit. Net \$19.50
- 144 Midwest Flea Fli 10 kit. Sale \$16.00
- 145 Falcon 56 RC \$19.95. Sale \$14.44

To Dealers, Clubs and Hobbyists:

If you live in California, Texas, Florida, New York or Illinois, we can have United Parcel Service deliver your order on your doorstep before your local supplier can. Like most hobby distributors or mail order discount houses, we carry all of the most popular demanding radio control lines. But, unlike most suppliers, we are a full-function hobby distributor and will offer you cash or trade-in for your old motors, used radio sets, built-up planes. It is not unusual for us to have 20 or 30 sets of *one* brand of RC units in stock at one time. Our inventory is never under 100 built-up airplanes. We have a firm offer of a new EK 6 channel champion or MRC4 channel #724 set for an M-5, 5 cyl motor or 4 cyl Elf Engine. Trade even. We know of no other distributor that will offer this much. We would offer you a catalog, but manufacturers' continuous new price increases forbid it. But do send for our special on-hand and just-arrived discount sheets. Besides our one of a kind built-up RC planes, and low-priced full house used proportional sets, we have an exclusive new radio set - Digital U.S.A. - that we retail at \$175.00 - 4 channel - 2 stick. This unit has been reported to have more range and in sight control than the higher priced sets and is priced right to sell. Also we have the exclusive MG - Scale wheels in all popular sizes - with partial removable hub for mechanical brake inserts. Try us for that 23 hour service.

In the meantime, if you see anything advertised you would like to have, just clip out the ad and mail in with your remittance. Also, our special professional counseling is free for the asking. Our batting average for getting our customers airborne is 999 out of 1000 - don't be left out. Call us for those COD orders - we are here day and night. Special this month only - Blue Max 4 ch 2 stick Series II - \$330.00 - Sale \$205.00

Kits and Motors

- 146 Sterling Ringmaster. \$7.95 kit. Sale \$6.00
- 147 VK Cherokee. \$39.95. Net \$27.77
- 147 Touchdown Trainer \$21.95 Sale \$16.50
- 148 VK Cherokee Babe \$27.50 Sale \$18.18
- 149 OS 10RC \$14.98 Sale \$10.00
- 150 OS 20RC \$21.50 Sale \$14.00
- 151 KB40 No. 8056 or 8013 RC. Sale \$20.00
- 152 McCoy 19RC with Perry carb. \$17.00
- 153 McCoy 35RC with Perry carb. \$20.00
- 154 Dubro Cherokee Arrow. List \$39.95. Sale \$27.00
- 155 T 2 Glider. superior models. \$29.95. Sale \$22.22

Motor and Kit Combo

- 201 TF P 40 and Veco 50 RC. value \$100.00. Special Sale \$66.66
- 202 Lanier Comet II plus Webra 61 RC. Sale \$95.00
- 203 VK Triplane kit and webra. 61 RC. retail \$141.50. You pay \$88.88
- 204 Midwest Trisquire (this plane will forgive you) or Headmaster and ST 23RC (trainer combination). \$41.45 value. Sale \$30.00
- 205 Testors no. 4900 Cosmic. Wind UC 1/4 049 engine. list \$12.95. net \$9.50
- 206 Cox PT 19 trainer with Baby Bee 049. Sale \$9.95
- ALL LANIER KITS IN STOCK AT LOWEST PRICES.
- 207 Texan AT 6. 53" wing plus OS-20RC. \$63.50 value. Sale \$44.44

Specials

- 801 Wing super olymic retrac unit. \$18.00 new. Sale \$13.33
- 802 Ace dual charger \$9.95.
- 803 EK nicad pak & harness for LR B 3 ch. \$21.00 \$17.77
- 804 EK charger for above \$5.55
- 805 Tatonne no 030454 custom engine mt for RR 40RDC (K&B). \$4.95 net. Sale \$3.25
- 806 Assortment 1955 1970 all magazines. Sale 50 for \$25.00.
- 807 SALE IGNITION ENGINES 10 ASSORTED GOOD TO START COLLECTION AND FOR SPARES. \$250.00
- 808 Testors Dope 1 oz. bottles. nitrate or buterate 10 cents each 4 oz. bottles. 25 cents each.
- 809 20 sheets 1 16th x 4 x 36 balsa \$12.00 Net \$8.00
- 810 20 sheets balsa 1 16th x 3 x 36 \$8.00 Net \$5.50

Motor, Kit and RC-Unit

- 701-Lanier Comet II, Fox Eagle 60RC and Digital U. S. A., 4 ch., completely installed, ready to fly. Just gas up. \$300.00. All new.
- 702-Canyon Schweiger 1-26 sailplane plus EK. log 3 ch., \$150.00 value. All for \$110.00. Super Star Sale!
- 703-Dee Bee Cardinal (\$39.95) Digit Midget 3 ch. (\$200.00) ST 23 RC (\$23.95). All for \$199.95. Super Sale!
- 704 - EK Champion. 6 ch., single stick \$369.95; P-40 \$49.95; plus OS60RC \$59.95; total value \$479.85. Sale \$355.55
- 705 - EK Champion. 6 ch. 2 stick \$349.95; Pilot Skywagon \$49.95; plus Veco 50RC \$50.00; total value \$449.90. Sale \$333.33
- 706 - EK. 3 ch. \$119.95; Midwest El Juan Glider \$29.95; total value \$149.90. Sale. \$114.44
- 707 - EK. 3 ch., 3 servos \$159.90; Pronto \$17.95; ST-23RC \$23.98; total value \$202. Sale. \$159.95 Super Special
- 708 - MRC. 4 ch., single stick \$320.00; Dee Bee Cessna Cardinal \$39.95; OS 35RC \$24.50; super special value \$384.54. Sale. \$272.22
- 709 - MRC. 3 ch. \$210.00; Midwest Trisquire \$17.95; OS20RC \$21.50; full retail value \$288.45. Sale. \$175.00
- 710 - MRC 4 ch., single stick, TX. rec., 2 servos \$200.00; AF1 Glider Monterey \$29.95; total value \$229.95. Sale. \$166.66
- 711 - Blue Max 4 ch., 2 stick, built-up \$330.00; Contender \$34.95; Webra 40RC \$63.95; retail \$428.90. Sale. \$266.66

Proportional Sets

- 301 EK 3 ch \$119.95 Sale \$90.00
- 302 EK 3 ch. and extra \$40.00 servo \$159.95 Sale \$120.00
- 303 EK 3 ch servo & pak & ch for rec. \$188.00 Sale \$137.77
- 304 New Ek Logiptrac 3 ch set with 2 servos list \$119.95 Sale \$90.00 With 3 servos \$120.00
- 305 Digital U.S.A. 4 ch 2 stick \$175.00 Digital U.S.A. 6 ch. 2 stick \$200.00 Series 1938 These prices are below retail costs of semi kits. Small receiver amplifiers are in the servos and not in receiver. Completely assembled from EK products components
- 306 MRC 4 ch single stick, complete set \$310.00 Sale \$240.00
- 307 New 1971 OS 2 ch complete with Airborne nicad pak retail \$139.95 Sale \$100.00
- 308 New Digit Pylon 4 ch single stick, small servos regular \$265.00 Sale \$205.00

Let Hobby Capitol U. S. A. help you make this a "model" Christmas.

RADIO CONTROL, U-CONTROL, FREE FLIGHT (and old time free flight) CAPITOL of the U.S.

Phone (615) 256-1169

EST. 1951

Home (615) 352-4380

HOBBIY CAPITOL U.S.A.

★903 Church Street, Nashville, Tennessee 37203★

Built-up RC Planes

- 601 PT-17 biplane 70" wing, all yellow, wheels, rods, silked \$195.00
- 602 P-40 very clean, silked rods, flaps, wheels very clean and deluxe \$195.00
- 603 Contender colorful for 40-60 engine \$125.00
- 604 Middle Stik for 30-45 engine \$125.00
- 605 Antic with wheels and rods, no trouble to fly \$225.00
- 606 Vic's custom Great Lakes Trainer \$225.00
- 607 66" P-51 D, flaps, wheels, rods \$150.00
- 608 Shoestring for 40 engine \$70.00
- 609 Rand Little Hawk ailerons, very clean for St 23RC, will do full pattern, \$55.55 Special!
- 610 New Orleans pattern ship, deluxe \$140.00
- 611 Built-up RC car racing corbra orbit 3 ch radio, all working, 3 servos, Veco 19RC, all installed including charges, like new \$260.00
- 612 Debolt Cobra, very clean, gloss finish, silked, webra 40RC (\$63.95), new 5 ch, MRC 710 on 72MC (\$350.00), all mounted, ready to go, Full value \$425.00
- 613 - Sr. Falcon, Topwing for 45-60, silked \$95.00
- 614 P-51-B, rivet detail, retracts for 60RC \$125.00 Sale!
- 615 - VK Navaho, topwing for 45-60, very deluxe \$125.00
- 616 - Skylark - 56 - ailerons, silked \$50.
- 617 Debolt Jenny, top wing trainer, steerable nose \$75.00
- 618 - Immaculate Aeromaster Biplane \$195.
- 619 - Lanier Minnow \$75.00
- 620 - Original Jet Sabre Pattern semi-scale clean \$115.00
- 621 Skylark 62, silked, new 1/4 Enya 45RC \$225.00
- 622 Trainermaster, deluxe with ST 56RC, \$160.00
- 623 Middle Stik deluxe \$140.00
- 624 Sig Chipmunk 1/2 pylon racer \$70.00
- 625 Skylark Deluxe \$225.00
- 626 DH Moth biplane for 35RC, silked \$110.
- 627 VK Cherokee, silked, a good trainer for pattern \$110.00
- 628 Sr Falcon, topwing for 45-60, silked \$95.00
- 629 P-51 B rivet detail, retracts for 60 RC \$125.00
- 630 Skylark 56 with ailerons \$75.00
- 631 New Nimfire, all red, clean \$80.00
- 632 Cessna Skylark 62, ailerons \$95.00
- 633 66" P-51 D, with flaps, silver \$120.
- 634 Royal Products Sr. Skylark 72" wing built light, will fly with 60 \$175.00
- 635 Tri-pacer, built-up, 58" wingspan, all new, steerable nose gear, McCoy 29RC, silked, very deluxe, very scale, red and yellow \$150.00
- 636 Taurus for 50-60 engine, silked, beginners low wing pattern ship \$95.00
- 637 Built-up, new silked old time, free light buzzard bombshell \$110.00
- 638 Andrews Trainermaster, silked, neat and built right \$140.00
- 639 Twin Cessna 310 with two ST 35RC, been tested, flaps, rods \$200.00
- With Heath RC 5 servos, all working, all installed \$360.00
- 640 Consolidated spirit, high wing trainer 54" wing for 19.25 engine, very clean, silked \$65.00
- 641 70" PT 17 Biplane, all yellow, silked, rods, wheels \$175.00
- 642 P-51 B with retracts, all new, scale color \$125.00
- Professionally built Thunder Stormer contest pattern ship \$135.00
- 643 Commanche, all white and red trim, 72" wing, steerable nose gear, all rods & wheels \$175.00

Let HOBBY CAPITOL U.S.A. help you make this a *model* Christmas



Pictured is Carl Miller, Manager of Hobby Capitol U.S.A.

Built-up RC Planes

- 644 Twin Skylark, 2 OS 15RC, ready for radio, wheels, rods, steerable nose \$140.
- 645 66" P-51 flaps, racing red color, deluxe, clean, professional workmanship, built light and strong a scale finish \$175.00
- 646 Lanier Transit, built-up, top wing trainer \$45.00
- 647 Midget 1/4 Pylon Racers, chipmunk ME 109 P-51 minnow, top dawg, all for 15RC engines \$40.00 each.
- 648 Williams Bros. La Jolleta for 40RC, very clean \$125.00, Deluxe \$125.00
- 649 Scale Ecoupe 62" for 50-60 engine, all white and red trim, brilliant finish \$150.00
- 650 Major Model Folke Wolfe 190 for 40 engine \$129.95
- 651 Yak No. 18 sig, silked, tri-gear, 72" wingspan, scale finish plus markings \$125
- 652 Royal Products Zero Jr. mounts for OS40RC, silked, WW 2 colors, built to fly \$125.00
- 653 Royal Products Lil Stinker for 60-71 engine, deluxe, scale sunburst finish \$225
- 654 54" deluxe, silked, monocoque, yellow and black trim, ideal scale for 40RC flaps, ailerons, steerable tail wheel with rudder \$200.00
- 655 Original jet sabre pattern, semi-scale clean \$115.00
- 656 Quik Fli III, tapered wing, silked \$125.00

- 657 Trainermaster deluxe, with ST 56RC \$160.00
- 658 Baker's Top Dawg for 1/4 Midget Pylon for Fox 15RC \$60.00
- 659 Miss Bikini, low wing sport plane, high gloss finish, white and blue trim, silked and very clean \$75.00
- 660 Cobra, hobby poxi-finish, very clean, built from mag. plans \$125.00
- 661 Deluxe stormer, silked, very clean, a good top wing trainer \$125.00
- 662 Deluxe astra hog 72" low wing with fly slow with 45.50 engine \$125.00
- 663 PCM 8 Glider \$50.00
- 664 J & J T-Craft ailerons \$75.00
- 665 Original class II Pylon Racer, very nice 600 sq in. for 40 engine \$90.00

MISCELLANEOUS

SUPER MONOCOAT—still \$6.10 a roll, 3 for \$17.77, and 10 for \$55.55.

- 401—MG, mirror finish, nylon hub wheels, Scale like 3" Sale. \$2.00 pr.
- Scale like 2 3/4" Sale. \$1.85 pr.
- Scale like 2 1/2" Sale. \$1.65 pr.
- Low Bounce 3" Sale. \$1.65 pr.
- Low Bounce 2 3/4" Sale. \$1.50 pr.
- Low Bounce 2 1/2" Sale. \$1.40 pr.

Used Proportional Sets

- 401 C-ship 5 ch. with extra airborne pak, 8 servos, 2 rec. all for \$200.00
- 402 Bonner Digmite, 4 ch., 4 servos, working, clean \$140.00
- 403 F & M 5 ch., working, 5 servos, complete \$140.00
- 404 F & M 3 ch., 3 servos \$95.00
- 405 C-ship 5 ch. set with 4 servos, complete set \$135.00
- 406 Heathkit built-up, like new, 5 ch. with four KP servos, working \$150.00
- 407 Kraft KP6B 6 ch., 2 stick, 13 servos, 2 receivers, 1 TX, pak & ch. cord, all for \$225.00
- 408 Dee Bee Eng. Quadruplex CL 5, complete set, like new with 4 servos \$125.00
- 409 Orbit 4 ch. single stick, complete, working \$150.00
- 410 Sampey 404, single stick, 4 ch., 4 servos \$95.00
- 411 710 MRC, 5 ch., 2 stick, 4 servos, working \$160.00
- 412 OS DP 4P, complete, working set \$150.00
- 413 Digit migit 3 ch., 3 servos, complete, working set \$100.00
- 414 Krift KP2B, complete set, no batteries \$75.00
- 415 Bonner 8 ch., 4 servos, complete, working \$155.00
- 416 MRC 2 servose, complete, like new \$95.00
- 417 Heathkit 5 ch., like new, complete, working \$160.00
- 418 Sampey 404, single stick, 4 ch., servos, Sale \$75.00
- 419 Like new Heath on 72MC, 5 ch., with 5 KPS, 9 servos, very clean and working, complete set \$175.00
- 420 Orbit 6 1/2 rec. (2 1/2" X 1 1/4" X 3/4") micro DS 3 rec., 4 servos, pak and charger, all on 27.145 MC \$110.00

Please order by number

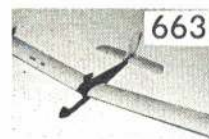
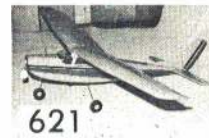

Used RC Gear

- 501 Used transmitters, reed servos, always \$8.00 each
- 502 6 ch., C-ship, SL-6, multi reed, 3 servos, wired \$55.00
- 503 Orbit 10 ch. TX, rec. with medeo reed bank & 5 servos, transmitters, nicad pak all for \$70.00
- 504 C-Air GG set, TX, rec. and ghost actuator, clean, Sale \$50.00
- 505 OS Pixie, small TX, rec. SH, 2 servos like new \$30.00
- 506 Like new mule TX on 27.195, rec. & SN, Esc \$25.00
- 507 C-Air GG set complete with nicad & Rand Dual pak, like new, Sale \$60.00
- 508 Like new Ace Commander TX, nicads in TX, chargers, nicads for rec., rec & small adams actuator doesn't look like it's been used, All for \$50.00
- 509 C-Air 6 ch. rec. & TX, 3 servos, charger & pak \$50.00
- 510 Very clean F & M 10 ch. matador & midas rec., 5 transmitters, nicad pak & charger, All for \$70.00
- 511 F & M Hercules TX, rec, 5 transmitters, medco nicad pak, all wired \$60.00
- 512 Ace RC Kraft 10 ch. TX & Sh. rec \$30.00
- 513 Kraft Custom 10 ch. TX, rec., all SH, multi reed, 5 servos, nicad pak, All for \$65.00
- 514 Tone transmitter monitors, used \$5.00
- 515 Shows R O Pulser \$5.00
- 517 F & M 10 ch. Reed 5 servos, Nicad Pak \$60.00
- 518 C-Air Mule Mark II, single ch., TX \$11.00
- 519 Deltron No. 109 TX & rec., single ch \$12.50
- Babcock BCT-18 TX & BCR-18, rec. \$18.00
- 520 C-ship JSH, rec. in box, (S49 98), Sale \$10.00
- 521 CG Pioneer Rec, like new \$8.00
- 522 Rand Dual Rand Pak (\$75.00), like new \$22.00
- 523 CS Rec. C & S Mark V, actuator and Nicad Pak \$15.00
- 524 C & S Pulsi Tran, CS 504 and Falcon III TX, like new \$15.00
- 525 Ace Sim-Pulse TX, Sim Plus \$15.00
- 526 Ace Pulse TX, rec. actuator, nicads & ch \$60.00
- 527 Testors Simpulse TX, rec., nicads, actuators & ch \$40.00
- 528 Royal GG 1 TX, rec. Rand Single Pak & ch \$60.00
- 529 C-Air GG Set, TX, rec. Ghost actuator, battery box \$40.00

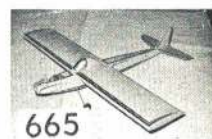
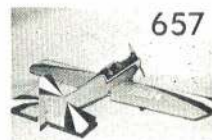
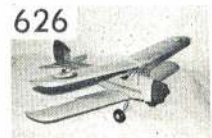

RADIO CONTROL, U-CONTROL, FREE FLIGHT (and old time free flight) CAPITOL of the U.S.

Phone (615) 256-1169

EST. 1951

Home (615) 352-4380

HOBBY CAPITOL U.S.A.

★903 Church Street, Nashville, Tennessee 37203★

QUALITY HOBBY SHOPS

Quality Hobby Shop spaces are sold on a six-month basis at \$7.00 per month, payable in advance. All insertions must be consecutive. No mention of mail-order business is permitted. Closing Date: 10th of third preceding month.

NEW YORK—BUFFALO

Factory authorized Orbit and Micro-Avionics sales-service center. New Orbit and Micro radio systems at very best prices. Complete stock of parts and accessories. Immediate service on all Orbit and 1970 Micro systems. Guaranteed reconditioned previously owned Orbit systems always available.

ORBIT NORTHEAST

3833 Harlem Rd. 14215 (716) 836-6860

OHIO—CLEVELAND

We carry the most complete line in Ohio for your model airplane hobby. Also large HO train dept., Boats, R/C, motors, parts, supplies, dope, balsa, tools, books, magazines, etc.

NATIONAL HOBBY, INC.

5238 Ridge Road (216) 749-4750

MASSACHUSETTS—CAMBRIDGE

Model planes, motors, railroads, ships, radio control equipment and accessories—also slot racing supplies. Open 9:00 AM to 5:30 PM daily & Thurs. evenings.

CROSBY'S HOBBY CENTRE

1704 Massachusetts Ave. (617) 547-4389

NEW JERSEY—IRVINGTON

The oldest established hobby shop in New Jersey. Everything in trains, ships, planes and rocketry. Hours 10 to 7 daily, 10 to 1 on Sunday.

THE HOBBY SHOP

758 Springfield Ave. (201) 372-6211

PORTLAND—OREGON

Portland's Headquarters for Radio Control Equipment, all major brands all at discount prices. "Shop American," "The Friendly Shop."

AMERICAN PET & MODEL AIRPLANE SUPPLY COMPANY

4308 S.E. King Rd. in the Disco Mart shopping center. Ph. 654-8777 Zip: 97222

SOUTH CAROLINA—BEECH ISLAND

Near Augusta, Georgia. Headquarters for Radio Control Supplies—kits—motors and hard to get items. Building of kits or custom model. Open 9 a.m. till 11 p.m. plus Sundays till 1 p.m.

MILLER'S HOBBY SHOP

315 Laurie Drive (803) 822-0565

COLON, REPUBLIC OF PANAMA

The only hobby shop in the country. Model Planes, Motors (radio controlled), ships, H.O. and N. Gauge trains, complete stock of parts and accessories.

KELNIA S.A.

Front Street, Colon, P.O. Box 2086, Zone 3, Telephone, 47-7040. Warehouse in the Free Zone of Colon.

MICHIGAN—DETROIT (FERNDALE)

Trains, planes, stamps, coins, R-ways. Over 50,000 items for hobbyists. Mich. largest antique train collection. Look for our 55' RR crossing sign, Arnold Rapido.

MODELS HOBBY CENTER

22524 Woodward Ave. (Zip 48220) LI-3-2242

GEORGIA—DECATUR

HO Railroads, Planes, Model Car Racing. Open 11 AM to 10 PM. Metro Atlanta's Friendly hobby shop.

HOBBY HOUSE DECATUR SPEEDWAY

130 E. Ponce de Leon 378-2253

HONG KONG—KOWLOON

The most complete stock of aeromodelling and hobby supplies in the Far East. Sole agents for Graupner, O.S. and Min-X and agents for Vernon, Frog, Solarbo and many others.

RADAR CO., LTD.

2 Observatory Road Kowloon, Hong Kong K-680-507

AVONDALE ESTATES, GEORGIA

Southeastern factory repair center for Micro Avionics and Orbit systems. Complete stock of parts. All work guaranteed. Parts in stock for Blue Max and most systems. Authorized factory service center for Testors planes and radios.

HOBBY DISTRIBUTORS

4 Avondale Road, P.O. Box 102, Avondale Estates, Georgia 30002

ALABAMA—BIRMINGHAM

If it's hobbies, we have it. Most complete line in Southeast. Model airplanes, motors, trains, slot cars, Radio Control equipment—cars, planes, boats and accessories.

SPIVEY DISCOUNT

1303 Tuscaloosa Ave. 205-785-9690

RHODE ISLAND—PAWTUCKET

Radio Control, Model Planes, Motors, Ships, Rocketry, Arts Crafts, Slot Racing, Parts and Accessories, H.O. & N Gauge Trains, Open 6:30 P.M. to 10:00 P.M. Daily & Saturdays 12:30-5:00 P.M.

R & M HOBBIES

81 Columbus Avenue (Zip 03860)

(401) 728-4320

OHIO—JAMESTOWN

Radio Control Specialist. Have done professional building and consultation for research work. Retail stock consists of Radios, Engines, Mufflers, Kits (Arf. & Balsa), R.C. Helicopter Kits & most support items for R.C. Discount prices. 15 years experience at your service. 6-10 Eve. 10-6 Sat.

MID-OHIO RADIO CONTROL

3949 N. Lake Shore Drive 513-675-2613

VIRGINIA—ARLINGTON

Washington D.C. Area? Try us First! Model aircraft, R/C, U/C, F/F., R/C Cars, boats, engines, accessories, equipment, publications, tools, unimat lathes and parts. Hours: Mon, Thurs, Fri: 10-9, Tues and Sat: 10-6.

ARLINGTON HOBBY CRAFTERS

625 N. Giebe Rd., Arlington, Va. 22203

522-6442

SOUTH CAROLINA—NEAR BOWMAN

Located on Road 36 just off I-26. Complete U-Control Center on 12-acre flying field. Big Discounts! Open 4 to 8 weekdays and all day Saturdays. Plenty of help for beginners. Flying every Sunday afternoon.

ACTION HOBBIES MODEL AIRPORT

Route No. 1, Box 53AB Bowman, S.C. 29018

MEXICO—MEXICO CITY

The most complete stock of aeromodelling and Radio Control supplies in Mexican Republic.

Factory authorized Kraft System, Pro Line System, Webra and H.P. Engines.

Sales and Service center, all best items and the best prices.

We accept Bancomatic & Bancomer Cards.

MATHELIN MODELISMO

Retorno 3 DeGral. Ignacio Zaragoza No. 47

Mexico 9, D.F. Tel: 5-71-75-07

WEST VIRGINIA—PARKERSBURG

Planes-R/C and Control Line, Engines and Accessories. All kinds of Goodies! Kraft Radios, Sig Products, Lionel Trains. Also HO and N gauge trains and accessories. HO slot track in stock. HO slot cars and parts. Craft and Hobby supplies.

WILSON HOBBY SHOP

Park Shopping Center, Parkersburg, W.Va. 26101 1-304-428-0713

COLORADO—COLORADO SPRINGS

Complete line of U-Control, Free Flight and Engines. Headquarters for R/C. We feature Royal Classic, Lee Engines, Sig Products. Master Charge. Discount to AMA Members. "We Fly What We Sell."

CUSTOM HOBBIES

2408 E. Platte Ave., Colorado Springs, Colo. 80909 (303) 634-7400

NEW MEXICO—ROSWELL

Radio control specialists serving the Southwest with all major brands of R/C equipment. See us for discount prices on kits, engines, radios, and any other supplies you might need.

AIRPORT R/C MODEL DEALERS

P.O. Box 387, Roswell, New Mexico 88201

AC 505 - 623-5734 or 622-4817

CLASSIFIED ADS

Rates: 30¢ per word (including name and address). Minimum—14 words. Send remittance with copy and order to: AMERICAN AIRCRAFT MODELER, 733 Fifteenth St., N. W., Washington, D. C. 20005.

R/C equipment sale. Stamp for catalog: J-F ELECTRONICS, 314 South 13th Avenue, Yakima, Washington 98902.

DIRIGIBLE. Build and fly 12' long remote controlled airship. Plans and book \$5.25. LTA Products, 15-A, William Street, Closter, New Jersey 07624.

BUILD THE U.S. COUPE D'HIVER that finished in the top 1/3 in France last year. PLANS \$1.50. FREE FLIGHT SPECIALTIES, 6255 S.W. 47th Pl., Portland, Ore. 97221.

SAVE \$K. KWIK Set epoxy 8 oz. \$4.95. Motor Klen varnish remover 1.40. Styro Stik foam wing adhesive 16 oz. \$1.79. Amber latex no rot fuel line 6 feet \$1.50 add 35 cents postage. Standard discount to dealers. GAS MODEL PRODUCTS, 110 Valley View, Southgate, Ky. 41071.

ELECTRIC FLIGHT IS HERE. ALPHA POWER UNIT—ELECTRIC PROPULSION SYSTEM FOR MODEL PLANES. CLEAN, QUIET, ALWAYS STARTS. GUARANTEED PERFORMANCE. LIGHTWEIGHT - 6.5 OUNCES. HIGH THRUST - 5 OUNCES. LONG RUN - 8 MINUTES, RECHARGES IN 1/2 HOUR. FLIGHT TESTED ON RC AND FREE FLIGHT PLANES. Files many planes "off the shelf" up to 1.5 lbs. loaded. CARL GOLDBERG SKYLANE, including DIAMOND, NORDIC 72 are just a few. ALPHA POWER UNIT includes Recharger, Motor, Prop, NiCad Battery. Completely assembled, ready to fly. \$45.50. F.F. Timer, RC Motor Controller also available. \$1.00 postage and handling. Send for FREE BROCHURE, FREE PLANE PLANS. Dealer inquiries invited. GALLER ELECTRONIC INDUSTRIES, P.O. Box 87, South Walpole, Massachusetts 02071.

CASTLE LION HOBBIES—WEBRA 61 RC—\$61.95. MRC 3CH-27MHz \$135.95, 5CH-27 MHz \$249.95, 5CH-72MHz \$266.75. Conn. Res. add 7% sales tax. No personal checks. Add \$2.00 postage and handling. P.O. Box 635, Branford, Conn. 06405.

SEASONS GREETINGS TO ALL OUR CUSTOMERS AND FELLOW MODELERS IN MAKING 1972 OUR 10th YEAR OUR BEST YET. NEW YEARS SPECIALS: SUPER TIGRES, G19 CAR \$26.75, G15 FI \$20.75, G15 FI RC \$24.75, G15/19 FI RC \$24.75, 23RC \$19.95, G21/29 RV ABC \$27.95, 40 RC \$23.95, 51 RC \$30.75, G65 RV ABC \$44.75, WANKEL 30 RC \$70.75. ALL POSTPAID. MOST SUPER TIGRE AND MAX ENGINES IN STOCK. ALSO PARTS. DON'S SALES, P.O. Box 224, Ft. Thomas, Ky. 41075.

PLASTIC KITS, Books, magazines, air brushes, compressors. Send large, stamped, self-addressed envelope for information. TOWNSELY, 512 El Portal Drive, Santa Rosa, Calif. 95401.

SCALE R/C PLANS. GRUMMAN TBF-1C* 1-1/8" scale, wingspan 60 3/4". GRUMMAN F6F-5 HELLCAT* 1 1/4" scale, wingspan 53 3/4". RYAN FR-1 FIREBALL* 1 1/2" scale, wingspan 60". BOEING F4B-4 1 1/4" scale, wingspan 52 1/2". GEE BEE R-1, 1932 PYLON RACER 2" scale, wingspan 50". Full size scale plans, two sheets 36 x 54" \$5.50 per set. *Scaled from measurements on actual aircraft. Send 20 cents for brochure. AER-O-SCALE, P.O. Box 3413, Granada Hills, Calif. 91344.

CURTISS HAWK P6E, Plans & Construction Manual, 2" Scale \$8.50 P.P.D. 1 1/2" Scale, \$6.50 P.P.D. CURTISS GOSHAWK F11C-2, Plans and Const. manual, 2" Scale only, \$8.50 P.P.D. BARRON'S ENTERPRISES, 1213 Holly Spring Lane, Grand Blanc, Michigan 48439.

WORLD WAR II R/C SCALE plans and kits. Illustrated catalog 25 cents. BUD NOSEN, Box 105A, Two Harbors, Minnesota 55616.

Fiberglass Wings, machine cut cores. Machine wrapped Epoxy skins laminated to styrofoam. Wings available for Koos A-6 Intruder, Californian Gladiator and many more. Send 10 cents for literature. \$24.95. Retracts add \$3.00. T&L GLASSFLITE WINGS, 20408 71st East, Sumner, Wash. 98390.

HAND CUT KITS: Beautiful Velle Monocoupe, rubber-powered \$7.95, plans \$2.25. The J3 Cub, 1/4A R/C or F/F kit \$14.95, plans \$3.00. Stamped envelope brings photo sheets from Flyline Models, 10643 Ashby Place, Fairfax, Va. 22030.

BIG SAVINGS! Complete line of R/C & U/C accessories. (Rev-up) props 7/4 to 1/4. Cos. S.T., O.S., Fox, K&B engines in stock. K&B Schn. 15 R/C \$28.95, O.S. 25 R/C \$19.95, Fox 36X \$12.95, Andrews (H Ray) \$16.95, DuBro Sea Bird \$42.95, Goldberg Shoestring \$6.95 and Devcon 2 1/2 oz. \$1.89. Just a sample of many items in stock. Postage paid on all orders. Send for free price list. B&N HOBBY CENTER, 5200 Rye Drive, Dayton, Ohio 45424.

OLDTIMER has those supplies we used long ago—Bamboo, nitrate dope, Pirelli, Tissue, Plans, Teflon washers, etc. List 8 cent stamp. OTM, 7454 W. Thurston Cir., Milwaukee, Wisconsin 53218.

CUTTING TOOLS, Precision tools, mills, reamers, dial calipers, more. Catalog 25 cents. RED, WHITE & BLUE Company, Box 654, Flagstaff, Arizona 86001.



Peace and Goodwill

MAY THE SPORT OF RADIO CONTROL
CONTINUE TO CONTRIBUTE TO UNDERSTANDING
AND FRIENDSHIP THROUGHOUT THE WORLD

KRAFT SYSTEMS INC.



Our most sophisticated piece of Equipment is the one at the top

It's the finished MRC-System. And it rests on a broad and versatile technological base.

MRC's overseas manufacturing facility is the largest complex in the world devoted solely to the design and production of R/C systems. Nothing is left to chance. Every component, subassembly, assembly, and finished system is monitored, checked, and measured through all stages of production. Every unit is bench tested and field evaluated. One out of every six manufacturing employees does nothing but test and inspect. That's only the beginning. When the system arrives at our

50,000 sq. ft. plant in Edison, N.J. we do it again. We bench test every unit for the second time. Then we put it through its paces again as a field operating system at our specially equipped field range.

In all, MRC's Edison, N.J. R/C test and service department is the best equipped in the industry. We've got the world's most advanced instrumentation. Shown above is just a small portion of the equipment, including Dana RF Digital Counter, Tektronix Digital Oscilloscope, Hewlett Packard Spectrum Analyzer, RF Commu-

nications' Synthesizer RF-Generator, Anritsu precision Field Strength Meter.

So when you finally do put your hands on an MRC R/C system, you can start enjoying it immediately. Because you'll have purchased one that has passed the industry's most rigid quality control procedures with flying colors. MRC's test checklist is indeed enormous. But so is our reputation for quality. MRC-F-710-5 channel, 27 and 72 MHz — available with Rotary or Linear Servos. MRC-F-713-3 channel, 27 and 72 MHz — available with Rotary or Linear Servos.