

THE WORLD'S ONLY RC SCALE MODEL MAGAZINE

INDOOR MICRO-SCALE:

AIRCO
WITH FULL
SIZE PULL-OUT
PLANS
(PART 2)
DH 6

Flying Scale Model

**ANDRAESON
BA-4**

**FULL SIZE
FREE
PLAN
WORTH £14.95**

30" WINGSPAN FOR
ELECTRIC POWER

www.flyingscalemodels.com



MASTERFUL

BIG, BIG BEAVER!

PLUS: SCALE THREE-VIEWS ● FULL SIZE STORY

REVIEW

WARHAWK!
DURAFly's CURTISS P-40N

ARTF WARBIRD COMES
COMPLETE WITH
RETRACTS INSTALLED!

**SMALL
TORQUE**

CONTRA-ROTATING PROPELLER
MECHANISM FOR SMALL ELECTRIC
AND RUBBER POWER



SHOWTIME

GAYDON GOSSIP! LMA SHOWCASE

February 2016
No. 195 £4.95



GET YOUR HANDS ON **ULTRA POWER**



CHARGE *...your passion*



OptiFUEL™ is one of the fastest growing brands in Europe with competition winning Nitro fuel products for the RC Model sector, now OptiFUEL™ is delighted to add a new brand OptiPOWER™ which will be the flagship brand for the new range of RC Chargers and LIPO cells.



> **ORDER NOW** FROM YOUR LOCAL RETAILER
FIND YOUR SPEC @ www.optipower.co.uk

OptiPOWER™
...your passion

THE ISSUE AHEAD...

FORMATION...

FLYING SCALE MODELS - THE WORLD'S ONLY MAGAZINE FOR SCALE MODEL FLYERS



14



26



32



ON THE COVER

Andreas Engels' DHC-2 Beaver was a hit at the 2015 LMA Cosford show and well it might be at a scale of 1:2.5 and with a wingspan of 148.6". Vallach five-cylinder four stroke powered, It weighs 202 lbs including approximately 12,000 rivets in its metal construction.

FEBRUARY 2016 NO.195

4 CONTACT

Just for starters

8 KIT REVIEW CURTISS P-40N

All wired up with retracts installed. Ken Sheppard test Durafly's ARTF warbird

14 TYPE HISTORY: CURTISS P-40 SERIES B TO N

Overshadowed by later WW2 fighters, the P-40 possessed vital availability when others were far from ready and proved a valuable machine within its capabilities

20 P-40 SCALE DRAWING

1:60 fine-line three-views show P-40D to P-40N and Kittyhawks Mk I to IV

22 SCALE SOARING

Successful end-of-season Ghost Squadron aerotow meet

26 FULL SIZE FREE PLAN FEATURE ANDRAESSON BA-4B

A 30.7" (778mm) wingspan 1/6 scale, electric powered model of the Swedish home-build aerobatic biplane designed by Peter Rake

32 QUIET ZONE

Peter Rake presents the final part of his micro-scale DH6 with pull-out plans for the wings

38 TECHNO SCALE

More scale web sites to click on

40 MASTER MODELS DHC-2 BEAVER

Andreas Engel's massive all-metal DHC-2 wowed the crowd at LMA Cosford 2015

46 BEAVER SCALE DRAWING

1:60 scale three-views showing the Beaver on wheels, floats and skis

48 SUBJECTS FOR SCALE DHC-2 BEAVER

A true workhorse-of-the-air and one that might even go on to score a century in service!

52 LMA GAYDON 2015

Alex Whittaker makes his first visit to the Gaydon indoor exhibition and likes it!

60 SMALL TORQUE

The late John Ralph conducted these successful experiments with contra-rotating propeller systems for small and electric and rubber powered free flight models

Editor: Tony Dowdeswell
Publisher: Alan Harman
Design: Peter Hutchinson
Website: ADH Webteam
Advertising Manager: Sean Leslie
Admin Manager: Hannah McLaurie
Office Manager: Paula Gray

FLYING SCALE MODELS is published monthly by ADH Publishing, Doolittle Mill, Doolittle Lane, Totternhoe, Beds, LU6 1QX. Reproduction in part or whole of any text, photograph or illustration without written permission from the publisher is strictly prohibited. While due care is taken to ensure the contents of Flying Scale Models is accurate, the publishers and printers cannot accept liability for errors and omissions. Advertisements are accepted for publication in FLYING SCALE MODELS only upon ADH Publishing's standard terms of acceptance of advertising, copies of which are available from the advertising sales department of FLYING SCALE MODELS.

EDITORIAL ADVERTISEMENT

& CIRCULATION: Doolittle Mill, Doolittle Lane, Totternhoe, Beds, LU6 1QX.
Tel. 01525 222573 Fax. 01525 222574.
Email: enquiries@adhpublishing.com

CIRCULATION TRADE ENQUIRIES:

Seymour Distribution, 2 East Poultry Avenue, London, EC1A 9PT
020 7429 4000.

NEWSTRADE: Select Publisher Services, 3 East Avenue, Bournemouth, BH3 7BW.
01202 586848
Email: tim@selectps.com

SUBSCRIPTIONS: Doolittle Mill, Doolittle Lane, Totternhoe, Beds, LU6 1QX.
Tel. 01525 222573. Fax. 01525 222574.

PRINTING: Symbian Print Intelligence, Calverley House, 45 Dane Street, Bishop's Stortford, Herts, CM23 3BT.
Tel: 0870 870 1670; Fax: 0870 870 1675

(c) Copyright Flying Scale Models 2016 ADH Publishing.

The paper used on this title is from sustainable forestry

CONTACT

The British Large Model Association is not a numerically large group, but it is, nonetheless, big in ambition and predominantly one dedicated to scale flying models. All of that comes through at their annual static show-and-tell get-together, now well established as an autumn event at the Heritage Motor Centre Motor Museum, Gaydon, near Banbury, Warwickshire.

Their ambitious approach comes through loud and clear in our report of their October event, in this issue, and in particular for the spread of modelling subjects that their members tackle - some of them subjects never previously attempted - and maybe never will again.

The sight of some of these certainly bring back memories for anyone who has had a life-long interest in matters aeronautical and who has enjoyed a life long enough to trigger such memories from many past decades, reaching back to a misspent youth!

The one at the show that really hit me between the eyes was the Blackburn Beverly, built, though still incomplete, by the late Malcolm Porte, and now in the hands of the Langar Model Club for completion. At 1/10th scale, it spans 162" and for me, brought back memories of my time in the Air Training Corps (2204 Sqdn).

One of the annual events for ATC cadets was the annual AOC's inspection that, one year in the late 1950s, took

place at RAF Benson, Oxfordshire, then an RAF Transport Command base and home to Blackburn Beverlys.

AOC's Inspections always took place on Sundays and after the morning Inspection, cadets were treated to 'air experience' in whatever aircraft the station had on hand - which that year was Blackburn's cavernous aerial tortoise that went everywhere to the last vestiges of British Empire outposts around the world, at the ultra-rapid rate of about 150 mph!

That weekend, leave for Beverly aircrew had been cancelled and they were on standby for an emergency deployment to Aden (now Yemen), then a British 'Protectorate' where long-brewing trouble with the locals was boiling over.

So for we ATC cadets, our 'air experience' was as passengers in Blackburn Beverly's - and what an experience it was, as at least two of these all-silver giants were hammered around at low level to the ear numbing rattle of four Bristol Centaurus engines in vibrational harmony with the totally non noise dampened airframe interiors. It was, indeed, an 'air experience' never to be forgotten. How anyone endured it all on those long runs to the last vestiges of British Empire, I dread to think!

Anyway, enough of all that! Just to say here - hats off to the continual scale modelling ambition of the Large Model Association members, which continues unbounded.

Long may it continue.



ME-163
950MM



YAK 52
1200MM

SCALING NEW HEIGHTS

SCALE DETAILS SUCH AS RETRACTABLE LANDING GEAR, FUNCTIONING FLAPS, NAVIGATION LIGHTS, ACCURATE IN SERVICE COLOUR SCHEMES, SCALE DETAIL PROPELLERS, POWERFUL BRUSHLESS ELECTRIC MOTOR.



SEA FURY
1200MM



P-40N
1100MM

DURAFLY

TAVHS

HobbyKing.com

www.flyingsca



NEVER MISS AN ISSUE
SUBSCRIBE TODAY!

www.adhpublishing.com

£42

Get your copy delivered to your doorstep before it reaches the newsagents by subscribing



www.adhpublishing.com



01525 222573



enquiries@adhpublishing.com



JOIN THE ELECTRONIC REVOLUTION

Enjoy FSM on your iPhone, iPad, Android phone or tablet PC.

Visit the App Store or Google Play and search for "Flying Scale Models" or visit PocketMags.com to purchase single issues and subscriptions to read on your device or PC.



Available on the iPhone
App Store



Google play

lemodels.com

Follow us on Facebook
facebook.com/pages/Flying-
Scale-Models/495012097186048

Follow us on Twitter
@ScaleModelFlyer



- MASTER MODELS
- TYPE HISTORY
- IN DETAIL
- SCALE DRAWINGS
- FREE PLANS
- CONSTRUCTION
- TECHNIQUE
- SHOW REPORTS
- FLYING COLOURS
- HOW TO'S
- GLIDERS
- ELECTRIC
- SCALE INDOOR
- SCALE REVIEWS
- SCRATCH BUILD

ALSO
AVAILABLE
FROM ADH
PUBLISHING...



www.adhpublishing.com/shop



SUBSCRIBE FOR ONLY **£44**



SUBSCRIBE FOR ONLY **£55**

SEE THE ADH
WEBSITE FOR MORE...



REVIEW



Warhawk

The Curtiss P-40N Warhawk ARTF from D



wwk!

Duraflly tested by Ken Sheppard

The Curtiss P-40 was one of the most widely used fighters of WW2 seeing more combat in more theatres globally than any other fighter from either side of the conflict. The last production model, the P-40 N was considered by pilots to be the best version of this versatile aircraft, so it's not surprising that one of the leading brands of foam scale ARTFs on the market should choose to model it.

From the first moment you clap eyes on the major assemblies in the box, you can see that the Duraflly P-40N captures beautifully the classic lines of this fighter, with super-smooth paint and surface finish with scale panel lines, and apparently - for the first time with a Duraflly 1100mm warbird - a factory-installed power train suitable for both 3S or 4S power set-ups, with no modifications required. A scale-sized three-blade prop and accurately profiled spinner completes the powertrain.

Also supplied with the kit are multiple decal sheets, allowing you to choose from five national markings, showing just how many countries used the P-40 in WW2. One of the key features of the full-size P-40 is its 'fold-rearward-and-twist' retracting main undercarriage. This has been reproduced and is factory installed, using 100° metal trunnions.

As one has come to expect, all the electronics are pre-installed, ready to connect to your choice of seven-channel Rx, with all lead ends clearly identified. Access to all the electronics is via the top 'engine' hatch, forward of the canopy (and pilot) and suitable air intake and air egress holes allow a flow of air over the battery and ESC. The model also has a bomb drop facility, using a unique 'reversing polarity' switch operated by the 7th channel. Quality is definitely the name of the game here.

Although not readily apparent on first inspection, Duraflly state that there is a higher-than-average level of reinforcement in the wing, due to the wing and retract geometry and, at an AUW of 45-49oz

(depending on the number of battery cells you decide to use), the P-40N is the heaviest single-engine Durafly warbird to date. However, it is also claimed that it boasts a well-designed wing and that, combined with its optimal power system, will ensure that the P-40N is Durafly's most enjoyable and realistic flying warbird yet - we'll see, a little later! Apparently, a 2,200mah 65C 3S lipo will give good scale performance, but a 2,200mah 25C 4S pack will really bring this model to life for sport and aerobatic flying!

The Build

The instructions are excellent and cover the assembly of the model very clearly, but as most of the work has been already done, there's not much to do, although I recommend first deciding what decal set you are going to use - and fit them BEFORE any assembly work!

However, the build work required is restricted to fitting the tailplane/elevator panels onto the carbon rod joiner through the fuselage and applying the two retaining screws either side, fitting the servo horns (two screws per horn) and adding the supplied pre-formed pushrods (not adjusted to length as supplied).

You then connect up the servo leads to your preferred Rx, bolt on the wing (four bolts), fit the lower cowling flap plastic moulding (two self-tappers), then fit the prop and spinner (the individual prop blades have to be screwed to the spinner backplate).

After that, you install the 3S (or 4S) lipo in the fuselage (as far forward as possible, snap on the canopy (the front lug holds the battery in place, whilst a small magnet retains the canopy at the rear) - and that's about it!

A pitot tube for the port wingtip and radio masts for the fuselage and fin are supplied, but in my experience, they don't last long at the field, or more likely, in the car. I left them off.

Decals

The individual decals are covered with clear vinyl sheet cut to shape, which need to be detached from the paper backing sheet, applied to the model and then the top clear vinyl cover is carefully removed by pulling back close to the decal surface, rather than at 90° to the surface and the remaining decal (very thin) fixed by using a low temperature cloth-covered covering iron. The result is very impressive when done correctly.

The USAAF scheme is the most complicated - and the most colourful - so consequently needs the most care. At first, I opted for the RAF scheme, but on checking my reference books, it would appear that all RAF Warhawks were painted in the normal two-colour camouflage rather than all-over drab green, so rather than spray on another partial layer of paint, I decided to take the easy way out and chose from the Russian, Dutch and Australian decals supplied. But they weren't as attractive as the US scheme, so - careful but colourful, it was!

Setting up

Set up the throws to the recommend values (they are just about right for scale like aerobatics, although I put in a bit more aileron after the first flight) - and check the CG - there is a 10mm recommended range, but I always balance on the front of the band i.e. in this case, 55mm from root wing LE. With the 4S battery in

“ From the first moment you clap eyes on the major assemblies in the box, you can see that the Durafly P-40N captures beautifully the classic lines of the fighter ”





The factory fitted electric retracting UC is a good fit in the wheel wells - note the hinged doors covering the oleo legs.



The wheels down showing more detail of the uc installation.



The top hatch gives access to the battery pack - note the pack is angled to get it fully forward.



View of the motor installation before the spinner and prop are fitted.



The moulded wing seat is very substantial and a very good fit with the wing.



Detail of the fin/rudder and the steering tailwheel linkage.



The two tail blades pushed together to show joiners and retaining lugs.

place, no extra lead was needed (note that the pack has to be inserted semi-rotated along its axis in order to get it as far forward as you can) ... and you are ready to go!

Whilst the instructions give low and high rates, no elevator/flaps mix is recommended. Whilst I anticipated no great trim change with the lower flap setting, I did think that a little 'down' elevator would be needed for the full flap deflection, so mixed in a couple of

degrees, and would recommend that anyone building this model do the same.

When fitting the flight pack, note that the pack has to be rotated slightly to get it to fit as far forward as it can. The retracts operate quite slowly and with a satisfying whine of the worm gears - whether they are up to the rigours of grass strip operation, we'll see! I would recommend first flights are made with the bomb not fitted, but it has to be said that all through the flight-testing, the retracts worked fine,

so no belly landing needed and secondly, if the wheels stay up for any reason, you can always jettison the bomb before attempting to slide in on the belly!

OK, all set up and a couple of flight packs fully charged, lets go flying!

Flying

Having flown quite a few ARTF foam warbirds of this size over the last few years, I was expecting the P-40 to have quite a bit of punch, even on the battery cells,



One of the flaps in full 'down' position - a little 'down' elevator mixed in is advised.



The prop blades a positively located and retained with a single self-tapping screw into the spinner backplate.



Well done, Durafly! A suitably suited pilot is supplied in the cockpit, ready for action.



Underside view showing the cooling air exit points - rear of the cowl and two holes in the rear fuselage belly. Note also the flap linkages.



The clever bomb release - the black mark on the end of the bomb pylon indicates the magnet which holds it in place.

SPECIFICATIONS:

Manufacturer: Durafly
Distributor: Hobbyking
Wingspan: 1100mm (43")
Servos: 7 x 9g micro (fitted)
Motor: 3536 900kv outrunner (fitted)
ESC: 45A brushless (fitted)
Prop: 10" x 5" 3-bladed (supplied)
Battery: 11.1v or 14.8v x 2200mAh 3/4S (recommended)
Weight: 1300-1400g (45-49oz.)
Function: 6/7-channel (Tx/Rx required)(optional bomb drop)
Kit part No: 9306000180-0
Price: \$195.43 (price varies with exchange rate)

requiring less than full throttle for scale-like flying, but the motor/prop/battery combo doesn't give it an overly high top end speed on the lower cell count pack, but more than enough for 'scale' flying, to these eyes; comfortable if you're flying in a gentle breeze, but perhaps a little on the edge if flying in anything stronger (bearing in mind this is a bit heavier than other Durafly foam fighters). Admittedly this was a first impression and I have gotten used to her over the dozen flights since that first flight, but to be honest, I am happier with the four-cell pack - you've always got the throttle, after all!

Having said that, from the off, the Warhawk proved to be a sweet little flier - looks good in the air and yes, those retracts handle grass with no problem - needs a up little elevator held in until she gets up to speed, but nothing unusual in that. Control response is positive, although I made a mental note to 'up' the aileron throw before the second flight. The stall is controllable - a wing does drop, but not

viciously and easing off the sticks and adding some power soon gets her back under control. Loops are large with no screw out and the rolls are barrelly without any rudder.

The first flight provoked quite a few flattering remarks from the assembled throng (they DO love a first flight!) and I have to say that despite its diminutive size, the Durafly P-40N definitely has 'presence' in the air. After a dozen flights and several outings in the boot of my car, she is beginning to look a bit war-weary, as most foam models do when transported and stored in one-piece format, but everything still works as it should, the retracts have certainly proved rugged on grass and the real test, I suppose, is that I love flying it, especially with the 4-cell pack! Recommended.

One final word of advice - when you drop the bomb, make sure the plane is close to you and low, it's easily lost if you hit the switch too early and/or too high! ■

AERODETAIL CD AVAILABLE FROM ADH

ONE OF THE LATER VERSIONS OF THE FAMOUS CURTISS WARHAWK, THE WW2 FIGHTER AIRCRAFT THAT SAW SERVICE IN JUST ABOUT EVERY COMBAT THEATRE OF OPERATIONS.

www.adhpublishing.co.uk/shop



The British Model Flying Association

Protecting and promoting
UK model flying for over
90 years.

BMFA

£25 Million liability cover
for all lawful recognised
model flying activity as standard.

Join at www.bmfa.org/join

2016 Fees

Senior £33, Junior £17,

Family Partner £22, Family Junior £13

Join via the website, over the phone or send payment with this advert

*Membership year runs to 31st Dec 2016

Mr/Mrs/Miss..... D.O.B.
Address.....
Postcode Tel:
E-mail Make Cheques payable to BMFA



BMFA, Chacksfield House
31 St Andrews Road, Leicester,
LE2 8RE
T: 0116 2440028
E: admin@bmfa.org

www.bmfa.org

Solarfilm

IRON-ON COVERING MATERIAL FOR FLYING MODELS

TO RECEIVE A SAMPLE PACK CONTAINING ALL PRODUCTS
& AVAILABLE COLOURS SEND FOUR FIRST CLASS STAMPS TO:-

 **Solarfilm Sales Ltd.** Ackhurst Rd, Chorley, Lancs. PR7 1NH England
Website www.Solarfilm.co.uk Tel 01257267418 Fax 01257276203

The Curtiss P-40

Overshadowed by later WW2 fighters, the P-40 possessed vital availability when others were far from ready and proved a valuable machine within its capabilities

During the two decades preceding the outbreak of WW2 in 1939, the Curtiss Company established itself as one of the dominant suppliers of fighter aircraft to both the US Army Air Corps and the US Navy, although, during that period, successive orders for new types were sparse by any standards - as was the case with other major air arms world-wide. Much of the Curtiss production of the period centred on the established biplane fighter layout and included the in-line Curtiss Conqueror powered Hawk P-6E for the USAAC and its radial engine variant, the F11C Goshawk.

By the early 1930s however, the era of the

fighter biplane was clearly fading in favour of the monoplane, spurred on by the development of new, more powerful engines. To ensure that they did not lose their ascendancy in the field as suppliers of fighter aircraft, in 1934 Curtiss embarked on design, and prototype build, of their radial engine Model 75 and the following year submitted this for a new USAAC fighter contract in which they found themselves in competition with the Seversky Company.

Neither aircraft actually met anticipated performance, but in this instance, it was the Seversky P-35 that took the initial contract. However, by the following year Curtiss had



eries

YOU BEND 'EM, WE MEND 'EM! Busy scene at No.7 Aircraft Salvage Unit, R.A.A.F Noomfoor, during 1944. That's quite a number of Curtiss Kittyhawks in various stages of distress. Judging by the bent propeller blades, the two nearest examples appear to have been wheels-up landing cases.



The XP-40 prototype as it first appeared, with fuselage underside air scoop at the wing trailing edge position. Later, during the prototype stage, this was moved forward under the nose.



Early P-40B , prior to USA entry to WW2 after Dec 7th 1941 attack on Pearl Harbour, Hawaii. This one is the squaron commander's aircraft, of the 33rd Pursuit Squadron.

applied improvements to their design, which then received a further USAAC production contract as the P-36.

Both the Seversky and Curtiss designs employed radial engines, but by 1937 the Allison Company introduced their in-line liquid cooled powerplant and Curtiss installed one in a P-36 airframe, the result - the prototype XP-40 - which first flew in October 1938 with Allison V-1710-19 engine, achieving 342 mph at 12,200 ft. - better than the Rolls Royce Merlin powered Hawker Hurricane (at least at that altitude), but inferior to the early Messerschmitt Bf 109 and Supermarine Spitfire.

Meanwhile, against a backdrop of a worsening international political situation, the USAAC was planning expansion and revised its performance requirements for all kinds of combat aircraft. However, the level of performance enhancement specified and the anticipated procurement numbers envisaged, could not be achieved simply by issuing a specification to an aircraft industry where available production facilities reflected previous procurement levels. Aircraft like the Lockheed P-38, Republic P-47 and (before long) the North American P-51 Mustang would take time to bring on stream.

Thus, despite its relatively modest performance, the P-40 was immediately available and when in April 1939, the US War department

awarded a contract for 524 P-40B aircraft at a price of almost 13 million Dollars, it was the largest US warplane contract placed since 1918.

Subsequently, throughout the Second World War, in an progressive and extensive range of variants, the Curtiss P-40 could be found in almost every theatre of action, and while the basic design stemmed from the Curtiss Hawk 81A, successive modifications gave the machine a confusing variety of names and alphabetical appendices. The official USAAF designations went from P-40B through to P-40N, the Curtiss designations from Hawk 81A to 87A, and the names from Tomahawk (P-40B & C) to Warhawk (P-40D to N) for the Americans and Kittyhawk in RAF Service!

For all that, the P-40, never an outstanding fighter by general standards, had two main attributes: it was available at times when fighter aircraft were urgently, sometimes desperately needed, and the type had an almost legendary reputation for absorbing battle damage.

At the beginning of 1940, an improved version of the Allison V-1710 liquid-cooled engine became available and Curtiss decided to re-design the P-40B/C (Tomahawk I/II) utilising this new 1,150 hp power unit. This resulted in a shortening of the overall length by six inches, a raised thrust line, and a consequent reduction in undercarriage leg length.



Classic Pacific island scene, with R.A.A.F Kittyhawk Mk.IVs (P-40N) undergoing routine servicing in the open air.



No.84 Sqdn RAAF Kittyhawks in formation over the Torres Strait island archipelago, right at the extreme northern tip of the eastern side of the Great Australian Bight. Machine in foreground is a Mk.IV, others Mk.III's. As with all RAF/Commonwealth aircraft in the Pacific combat theatre, the red centres of the roundels are omitted to avoid confusion with Japanese 'meat ball' insignia.



GOOFERS, technical term for off-duty flight deck crew, watch as P-40Fs of the 325th Fighter Group, USAAC, range on the flight deck of USS Ranger prior to launch on their way to Cazay airfield, Morocco during Operation Torch, for the invasion of North Africa in January 1943.

The fuselage cross-section was reduced and the radiator enlarged and moved forward. Cockpit area armour plate was fitted and the fuselage guns deleted, the armament now consisting of four 0.5in Browning guns in the wings. In May 1940, a British order for 560 of these machines was received, naming them Kittyhawks Mk. I, the US Army placing their quantity order for the more formal P-40D. The first flight took place on May 22nd, 1940. After delivery of 20 Kittyhawk Mk. Is, a further modification resulted in the armament being increased to six wing guns, the Mk. Is becoming Mk. IA (P-40E-1).

The British Kittyhawks were sent to North Africa, commencing action on New Year's Day, 1942 over the Western Desert, forming the equipment of Nos. 94, 112, 250, 260 and 450 RAF Squadrons, No. 3 RAAF and Nos. 2, 5, 7 and 11 SAAF. Further machines were sent to Canada, and a large number to the RAAF and RNZAF in the Pacific theatre.

On operations, several faults became apparent, the main one being that the Allison engine had a poor performance at altitude, as in the Tomahawk and in an effort to rectify this, Curtiss experimentally fitted a British-built Rolls-Royce Merlin 28 engine to a P-40D airframe, which proved to be a successful marriage. Production, using the Packard-built V-1650-1 Merlin, was eventually to a total 1,311 machines in the P-40F series, externally recognisable by the absence of the upper air scoop on the engine cowling. 250 of these machines were purchased with Lease-Lend funds for the RAF as the Kittyhawk MK II, but were re-allocated before delivery, going instead to the Soviet Union and to the Free French Air Force in North Africa. A large number were also retained by the US Army.

Another failing of the Kittyhawk (and all early P-40s) was a marked lack of directional stability, manifest in yawing during high-speed dives and in a

“ Curtiss emb...
P-40 would be o...

Line-up of P-40N Warhawks of 7th Fighter Squadron, 5th Air Force, USAAC, South West Pacific Area, at Cape Gloucester, New Britain, in June 1944. Warhawks and Kittyhawks were a substantial force in the South West Pacific combat zone.



A flight of P-40E and Fs.. The one in the foreground is a P-40E, showing the fin leading edge extension, while the other two are Packhard Merlin powered P-40Fs as identified by the lack of air scoop on top of the nose.



P-40N of the 45th Fighter Squadron on Nanumea Island, Elice Islands chain, South Pacific, December 1943. Colour is Coral pink overall to blend in with the coral island terrain.

tendency to 'ground loop' on take-off and landing. Regarding landings, a special technique had to be followed of touching down on the main wheels and then allowing the tail to drop, any attempt at a 'three-pointer' usually resulting in what the pilots described as an 'interesting arrival'! A modification in the form of a dorsal fin cured this tendency to some extent, being fitted to some late production Kittyhawk Mk. I/IIAs and standardised on the P-40K, the latter having a more powerful Allison engine of 1,325 hp. This model was known as the Kittyhawk Mk. III in the RAF, which slightly confused the recognition experts when another Mk. III made its appearance, without the dorsal fin and having a 2 f. 2 in. extension to the rear of the fuselage, which moved the fin noticeably aft of the tailplane. This was the P-40M, the structural modification also being applied to late-series P-40Ks and to the Merlin-

powered P-40F.

By 1944, the performance of existing P-40 variants, both American and Commonwealth operated, had fallen far behind that of fighter aircraft in general, and Curtiss embarked upon a major effort to improve the basic design to a degree where the P-40 would be of full operational value to the end of the war, which was now in sight. A new lightweight structure was devised, together with a general survey of components to see if further weight could be removed. The result was the P-40N, the fastest variant of all in its early form, with a maximum speed of 378 mph at 10,500 ft. Powered by the 1,470 hp Allison V-1710-99 or -81, the P-40N was known as the Warhawk to the US Army. But the 586 examples delivered to Great Britain under Lend-Lease were designated Kittyhawk Mk. IV, and while Nos. 250 and 450 Squadrons of the RAF were equipped with

this Mark in Italy, the majority went to the Far East and the Pacific for the RAAF and RNZAF. As the Kittyhawk Mk. IV progressed through its career, several modifications were inevitably ordered, including changes in engine Marks, increase in external stores capability, fitting of non-metallic self-sealing fuel tanks, new radio and oxygen equipment, and more obscure more minor alterations. But the only plainly visible change was the introduction, from the P-40N-5 onwards, of a frameless cockpit hood, the fuselage aft of the cockpit and under the rear perspex being cut down to a forward-sloping rectangular cross section for better rearward visibility.

The service history of the Kittyhawk and its US Army Warhawk counterpart is an impressive one and cannot be adequately covered in anything less than a full-length book. Never the fine-edged weapon that the Spitfire, Messerschmitt

.....
 worked upon a major effort to improve the basic design to a degree where the
 of full operational value to the end of the war, which was now in sight ”



109 and Mustang were, the Kittyhawk was a tough, hardy, machine, a redoubtable fighter-bomber and fighter too, in capable hands. Over 3,000 Kittyhawks were delivered to the Commonwealth Air Forces, including 1,500 Mk. I/IAs, 616 Mk. IIIs and 586 Mk. IVs. Of these totals, the RAAF received approximately 1,050 machines, and the RNZAF over 500.

From June, 1942 RAF Kittyhawks in the Western Desert, together with Squadrons of the SAAF and RAAF, were converted to carry bombs beneath the wings and fuselage to a total weight of 1,000 lbs and so armed, not forgetting the six 0.5 in machine guns, wrought much havoc among Rommel's forces. When used for

escorts to the light bomber Squadrons, they scored many successes in air-to-air combat, even against the superior Me 109 and Fw 190 and some returned to base with battle damage which would have brought down aircraft of less sturdy construction. The pilots of No.112 Squadron RAF were quick to follow the example of the American Volunteer Group in China, painting the fearsome 'Shark' motif on the eminently suitable noses of their mounts. The P-40 and Kittyhawk were noted for somewhat garish embellishment of their noses, and apart from sharks' heads there were tigers' heads with gaping jaws on a US Army unit in the Aleutian Islands, and an

enormous grinning skull on a Warhawk Squadron in Burma!

In the Pacific, the Kittyhawks of No.15 Squadron, RNZAF fought alongside their American allies from the island base of Guadalcanal in 1943. The first RAAF Squadrons in action were Nos. 75 and 76 which were sent North to defend Port Moresby in early 1942, where there were many air battles with Japanese fighters and bombers, the results of which scotched the rumour that the Kittyhawk was no match for the Japanese Zero. A decisive victory for the 'Aussies and Kiwis' was scored at Milne Bay in August 1942, when the incessant attacks by the Kittyhawks smashed an offensive by the Japanese Army, who were about to decimate a small American and Australian force, and then intended to take Port Moresby.

After the end of 1942, air-to-air combat became rare and the Kittyhawks became fighter-bombers and ground strafers to great effect.

Several examples of the Kittyhawk remain to this day throughout the world, carefully preserved, and several are in flying condition in the United States. The work of preservation by devoted enthusiasts cannot be better illustrated than that carried out by the Museum of Transport and Technology in Auckland, New Zealand, who rebuilt a Kittyhawk in



LAST OF THE LINE. One of the three P-40Q prototypes with bubble cockpit canopy and cut-down rear fuselage. Originally, a rounded wing tip shape was applied as with previous versions, but later, like this one, the tip shape was changed to a Mustang-like square-cut. Although offering a better performance than any previous P-40, it really did only what other in-service USAAC fighters were already doing.



two years from components rescued from all over that country, service sources, schools, garages and junk-yards.

Final variant of the Curtiss P-40 line was the P-40Q, which was an attempt to lift the performance to match that of the P-47 Thunderbolt, P-38 Lightning and P-51 Mustang, and to stave off the possibility of an end to production. Using the Allison V-1710-121 engine capable of delivering 1,425 hp., three prototype/development examples was produced, the first had the cooling radiators in the wings, in place of the chin type and was converted from a P-40K, with the standard cockpit canopy. The two that followed, featured a bubble-type cockpit canopy and one at least had clipped, squared-off wing tips similar in planform to the P-51 Mustang.

This variant achieved 422 mph at 25,000 ft with two-stage supercharger installed, but although this performance generally match that of existing USAAF front-line fighter types then in service, there

presumably was no reason to introduce a new fighter type that did no more than complicate training, maintenance diversification and spares inventory. No orders for the were forthcoming and production of the last of the P-40 line ceased in November 1944.

Criticism and praise have both been heaped on this long serving fighter aircraft of which nearly 14,000 were produced, in all variants, over a four year period. If considered against a backdrop of the 1940 air battles over Britain or even the subsequent epic daylight escort incursions into northern Europe, it was never up to the mark, but below 12,000 ft over the desert of North Africa it could out-turn a Messerschmitt Bf 109 and in the Pacific combat zone, could deliver an effective dive-and-zoom attack on the agile Japanese A6M Zeros and Ki-43 Oscars, so it was hardly a failure, just half a generation behind the later Allied fighter type alongside which it serviced.

Such then, was the Curtiss P-40 in its long and faithful service - never the best, but surely one of a fighter type deserving of recognition.

However, the P-40Q had one final hurrah when the second XP-40Q was an unauthorized starter in the 1947 Thompson Trophy race at Cleveland, Ohio. It was in fourth place when it caught fire and had to drop out of the race. ■

Restored and currently airworthy P-40M carries the 'Tiger's Head' nose art of type type applied to some aircraft of the 11th Air Force operating in the Aleutian Islands.



WING OF MK. IV BU-B. SHADED AREA IS WHITE, AND R.A.A.F. ROUNDLSIMILAR TO THAT APPLIED TO FUSELAGE. UNDERSURFACES EXACTLY SIMILAR. NB, WHITE AREA DOES NOT INCLUDE GUN MUZZLES.

N.B. UPPER WING ROUNDELS (R.A.F.) BLUE OUTER, RED INNER.

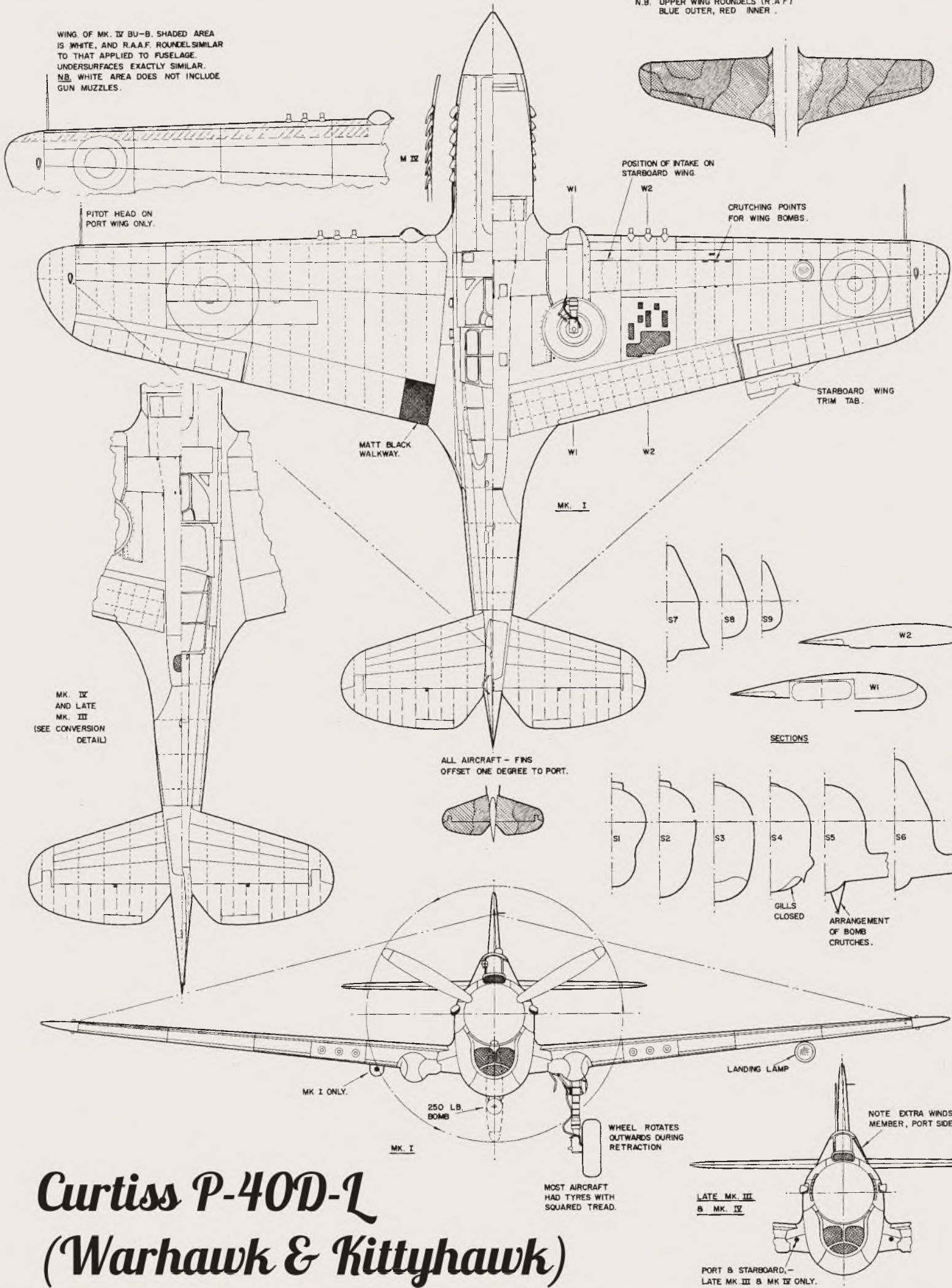

Curtiss P-40D-1 (Warhawk & Kittyhawk)

LATE MK. III & MK. IV

PORT & STARBOARD, - LATE MK. III & MK. IV ONLY.

MOST AIRCRAFT HAD TYRES WITH SQUARED TREAD.

MK. I

MK. I ONLY.

MK. IV AND LATE MK. III (SEE CONVERSION DETAIL)

ALL AIRCRAFT - FINS OFFSET ONE DEGREE TO PORT.

SECTIONS

GILLS CLOSED ARRANGEMENT OF BOMB CRUTCHES.

LANDING LAMP

WHEEL ROTATES OUTWARDS DURING RETRACTION

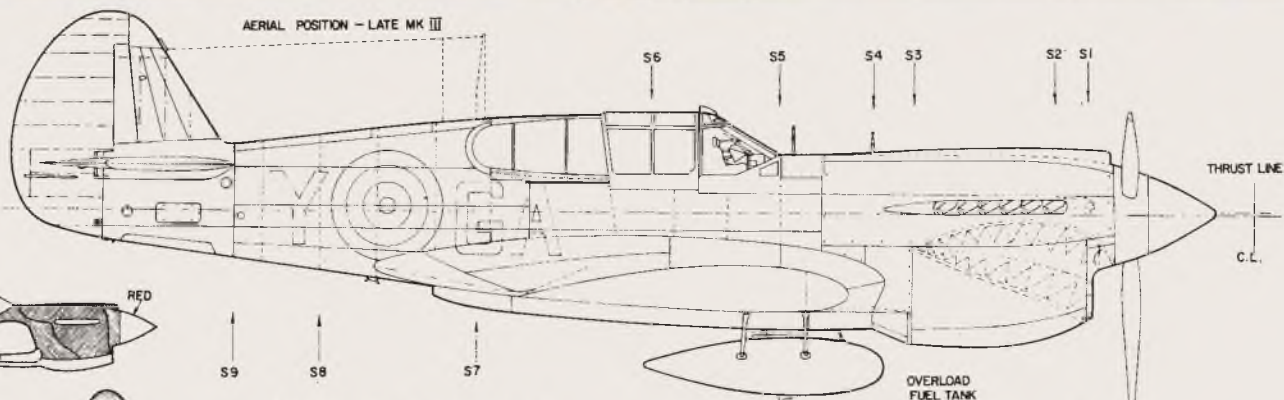

NOTE EXTRA WINDSCREEN MEMBER, PORT SIDE



KITTYHAWK MK I, N° 112 SQN R.A.F.
DESERT AIR FORCE,
GAMBUT, LIBYA, MAY 1942
(SGT. PILOT H.G. BURNLEY)

SERIAL N° OMITTED
TO SHOW DETAIL

COLOUR SCHEME GA-Y

-  MIDDLE STONE
-  DARK EARTH
-  AZURE BLUE

SERIAL NUMBER - BLACK
SQN. CODE LETTERS - WHITE
ROUNDELS -
NORMAL RED, WHITE, AND BLUE.
FUSELAGE ROUNDELS HAD
YELLOW OUTER RING
ALSO SEE PLAN VIEW

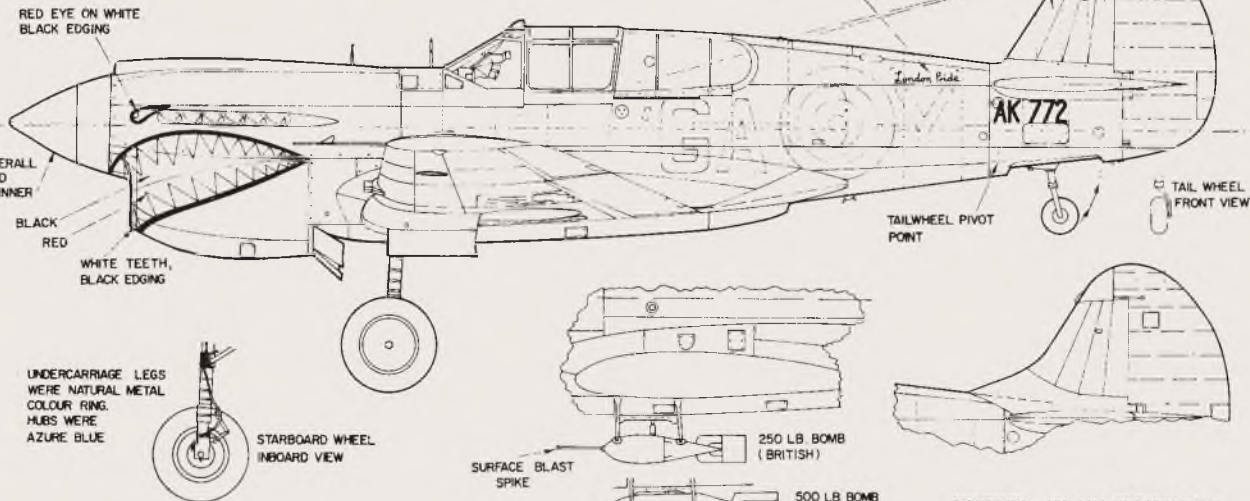

UNDERCARRIAGE LEGS
WERE NATURAL METAL
COLOUR RING.
HUBS WERE
AZURE BLUE

STARBOARD WHEEL
INBOARD VIEW

CONVERSION - MK. I/1A TO EARLY MK. III
ALSO FIT EXHAUST PIPES SHOWN BELOW
ON MK. IV. (U.S.A.A.F. P 40 K, AND
SOME LATE P 40 E.S.)

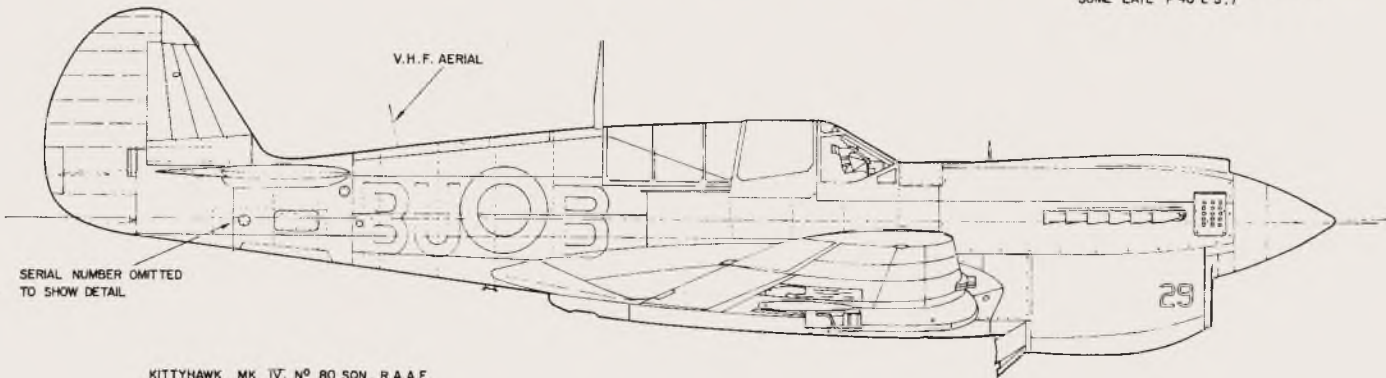

KITTYHAWK MK IV, N° 80 SQN, R.A.A.F.
1ST TACTICAL AIR FORCE,
MOROTAI, S.W. PACIFIC, LATE 1944.
(GP. CAPT. G.C. ATHERTON)

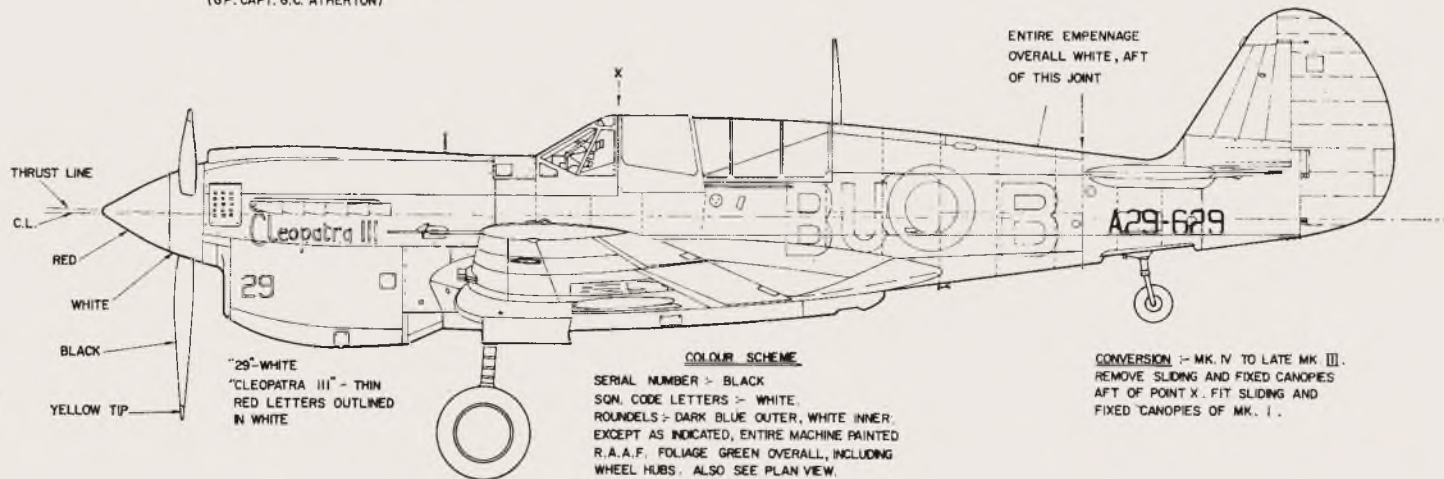

ENTIRE EMPENNAGE
OVERALL WHITE, AFT
OF THIS JOINT

CONVERSION - MK. IV TO LATE MK. III.
REMOVE SLIDING AND FIXED CANOPIES
AFT OF POINT X. FIT SLIDING AND
FIXED CANOPIES OF MK. I.

COLOUR SCHEME

SERIAL NUMBER - BLACK
SQN. CODE LETTERS - WHITE
ROUNDELS - DARK BLUE OUTER, WHITE INNER.
EXCEPT AS INDICATED, ENTIRE MACHINE PAINTED
R.A.A.F. FOLIAGE GREEN OVERALL, INCLUDING
WHEEL HUBS. ALSO SEE PLAN VIEW.
NOTE - TO OBTAIN FOLIAGE GREEN
(R.A.A.F. CODE N° K3/177)
MIX TWO PARTS HUMBRÖL MATT 30
TO ONE PART HUMBRÖL MATT 31

SCALE 1:60

On Silent Wings by Chris Williams

SCALE SOARING

I would imagine it to be highly unlikely that 2015 will have gone down in anyone's diary as a premium flying year, but for the scale soaring fraternity, the last event of the season at Middle Wallop certainly put the crack in the Christmas Cracker. For starters, courtesy of that nice Mr. Putin, a high pressure system all the way from Russia wrapped the UK in it's chilly embrace, and the strong breeze that was forecast failed to materialise, giving us some lovely smooth air to fly in, even if the lift was hard to find. As if that weren't enough, we had been promised a fly-by from the Avro Vulcan, which was in the final days of its flying career, an event keenly anticipated by all concerned (the fly-by that it is, not the final grounding).

In the days preceding the Aerotow, things did not look quite so rosy, though. New management at Middle Wallop had seemingly resulted in a ban on all types of model flying activity on this military base, as a variety of new brooms sought to sweep clean. With John Greenfield out of the loop due to family

concerns, it fell to tug pilot Pat Marsden to climb the mountain of paperwork that was required to make things happen, one of the spin-offs of which was that I felt it necessary to nominate him Man-of-the-Match!

As usual, there was much to see and admire as my pal Motley and I rolled up. Paul Bartlett's Duo Discus was one such machine, rendered more interesting by the sight of its red moustache. There was a time when the sight of a propeller perched on the front of a glass machine would cause a rash of pursed lips amongst the purists, but these days they have been forced down off their high chairs, because such things can now be found on the front of full size glass sailplanes.

Known as 'sustainers' the idea is that, should a glider pilot find himself low and out of ideas at the end of days soaring, he can unfurl said propeller and use it as a get-out-of-jail-free card. So, you still need an aerotow to get off the ground, but once airborne, the sky is your oyster. Paul's Duo was made by *Paritech*, to that company's very high standard (and price!), and was impressive indeed to

see in action.

Long-time Middle Wallop fan, Brian Sharp had come down all the way from Scotland, bringing with him his 1:3.5 scale ASW 20 from the newly revamped Pat Teakle kit and his 1/3rd scale own-design BGA 351. Over the weekend, he was the keenest of all to get a flight, and his face was never far from the ever-present glider queue. Being of Scottish descent, his reasoning was quite simple: the £300 cost of his weekend had to be divided by each flight accomplished. Obviously, the more flights he achieved during that time, the lower the unit cost of each flight! By my reckoning, the final cost-per-flight ratio must have worked out at around 10p!

During the Saturday evening, somebody came up with a pretty bright idea. Antonia Gigg's better half Mel was credited with the brainstorm and his notion was this...

During the half-hour stand down the next day, when the Vulcan fly-past was due to take place, might it be a good idea to place all the gliders in a delta formation on the ground in the hopes of catching the eye of pilot as he



At the front of the triangle of gliders, a Greenley tug, of course!



Paul Bartlett's impressive Paritech electrified Duo Discus.



Author's 2-seat Minimoa 2a drops its wheels (Barry Cole pic).



Steve Fraquet's 1/4 scale Goppingen Wolf gets its 1st tow under new management.



Mark Richards Swallow gets airborne behind Ray Watts' Red Bull tug.

flew by?

As V-hour approached, the tugs fell silent and the last of the gliders landed. (Brian, probably). There was a spate of feverish activity as the gliders and tugs were manhandled, with money changing hands to see who's model would be at the front of the formation, it turning out to be a tug, unsurprisingly. Once the task was completed, the crowd fell silent, eyes scanning the Eastern horizon. "...there she is..." someone shouted, and a dot became visible, trailing a thin plume of smoke. Soon, the familiar shape hove into sight, and a groan went up: it looked as though she was going to pass well to the North of us. As she came nearer, the pilot made a discernable turn to the left, and there she was, low and almost overhead, to the familiar turbine whine accompaniment.

The Vulcan then made a complete 360 and, could we believe it, came past once more. Now, it is believed in some quarters that the pilot saw the delta formation of gliders on the airfield and, filled with a natural human curiosity, came around for a closer look. This is a theory to which I subscribe wholeheartedly, and may God rot the socks of anyone who says different.

There is often talk of the 'Vulcan Howl', a noise peculiar to that particular machine. Well, there is another that makes a similar sound. Out for its annual outing, my 1/3rd scale DFS Habicht was once again cavorting in the skies above Middle Wallop. The Habicht was a German glider from the 1930s, designed specifically for aerobatics. It is reputed to have dived down into the arena during the 1936 Olympic Games with enough retained

energy to glide off again and land somewhere, so far unspecified by History. I find my 30lb model somewhat intimidating, if a lot of fun; hence its limited annual appearance. Flights are short, somewhere around two minutes each, as it is absolutely mandatory that aerobatics are committed as much as possible. This usually culminates in a



The perils of turning back! This L213a runs out of energy on the final turn.

relatively high speed pass and roll, during which a distinctive howl is heard. It's always fun to watch the uninitiated duck and turn white, muttering, "... strewth, wot the heck was that ..!"

In case you are wondering, the howl is caused by the strips of Mylar on the undersides of the wing vibrating in the slipstream when the ailerons are at full deflection. (To hear the howl yourself, Google 3RD SCALE HABICHT IN HD and hear it from the on-board video).

Staying on a personal note, there is another downside to using something only rarely. As this weekend was to be a special occasion, I decided to use the drop-off dolly on my two-seater Minimoa, the MO 2a. Normally it's too much faff to use it at an aerotow, as somebody has to run onto the take off area and retrieve the dolly. But it gets worse; I decided to utilise the headlight, too. (This was fitted to the fullsize, presumably to aid a record duration attempt that might terminate in a night landing.)

So, trying to remember which switch did what, terminated on the first flight with me releasing the towline instead of the wheel. The tug pilot said something in ancient Anglo Saxon, and then we re-set.

This time I got it right, released and turned on the light. (I don't know why: it's about as dim as a concussed tortoise). I flew around, but something didn't feel right: the Minimoa was wallowing around in the turns like a crab in handcuffs. The flight terminated in a 'Landing of Shame', whereupon I eventually realised that activating the light switch had had the inadvertent effect of knocking the adjacent switch and thus deactivating



Antonia Gigg's DG 303 Elan is followed home by a Greenley.



Author's 3rd scale Habicht on its annual outing (Barry Cole pic).

the C.A.R. Because the Minimod has an enormous all-moving rudder, the consequences are rather more noticeable than usual! I can tell you, I've gone right off the use of these aeronautical gadgets.

There wasn't too much in the way of glider damage over the weekend, but one incident did stick in my mind, which illustrated the perils of 'Turning Back'. I don't have a PPL of course, but in a lifetime of reading aviation literature I've come across the warning: never turn back if the engine fails on take off, unless there's an awful lot of altitude in the bank.

There is a glider equivalent to this situation, and that is when it becomes obvious to the pilot that his approach has been too high and if he's not careful, he's going to land a long way upwind with the subsequent 'walk-of-shame'. At the decision point, several factors come into play. Dependant on the height, a model with a forgiving and efficient wing section might well be able to turn back in a 360 and land safely. The alternative is to land straight ahead, or to S-turn, never more than ninety degrees to the wind. (Side-slipping is an option, of course, but let's not go there).

On this occasion, the unfortunate pilot of an L213a made the wrong call and decided to turn back. It's a buttock-clenching manoeuvre: the model will almost always get through the downwind leg unscathed only to come a cropper on the crosswind when it becomes obvious that there not enough left on the altimeter, and the unconscious desire to pull back on the stick takes over, with the resultant spin into the deck. That this model was built up from a kit with all the labour involved makes it all the worse and the moral is a sober one. It's better to be red in the face than to be forced back into the workshop.

When it was all finally over and we were packing car, Motley and I were of one mind...this had been one of the Ghost Squadron's best ever events: what a cracking way to end the year 2015. Thanks must go to the guys and gals of the GS for all their efforts, especially Mr. Marsden for all paperwork wrangling, and we can only hope for more of the same next year...

c_williams30@sky.com



Clive Learwood's Topaze gets a tow from Gary Page's Titan tug.





Man-of-the-Match tug pilot Pat Marsden takes a walk on the dark side with 1:3.5 scale Slingsby Petrel.



All the way from Scotland, Brian Sharp with his ASW 20.



Fantastic display at Middle Wallop from the full-size Vulcan on its swan song

ANDRAESSON BA4-B

A 30.7" (778mm) wingspan 1/6 scale, electric powered model of the Swedish home-build aerobatic biplane designed by Peter Rake with the prototype built by Alby King

This is another of those models that was drawn up some time ago but spent ages languishing on my computer because I didn't think I had enough photos for a construction article. It was only the advent of a dead computer, and checking through what I had backed up onto flash drive that revealed sufficient photos to be able to present the design for your delectation.

THE MODEL

As a quick perusal of the plan will reveal, this is a pretty straightforward model to

build. No complicated strutter, a simple box-like fuselage and even the undercarriage simply bolts into place.

As you can imagine with any model based on a home-built type, lots of variations are possible. This model, however is pretty much based on the prototype, as depicted in the three-view drawing supplied with a small rubber power model. As such, it shows ailerons on the lower wing only and a closed fronted cowl. Alby has gone for a slightly more generic version by adding upper wing ailerons, an open fronted cowl and spatted undercarriage. So, you have

ample choice as to the cosmetic appearance of your model, all possible from the design you see here.

WINGS

Since this is one of the areas where Alby deviated slightly from the original design, let's start there.

As you can see, both upper and lower wings are basically the same. Only the ailerons and aileron lead holes, along with the servo and wing mounts differentiate the two types of panel. So, if you wish to follow Alby's example, and have ailerons on all four wings, just build them into the

The spats and open cowl give Alby's model a very sporty look as it climbs away overhead.



“ As you can imagine with any model based on a home-built type, lots of variations are possible ”

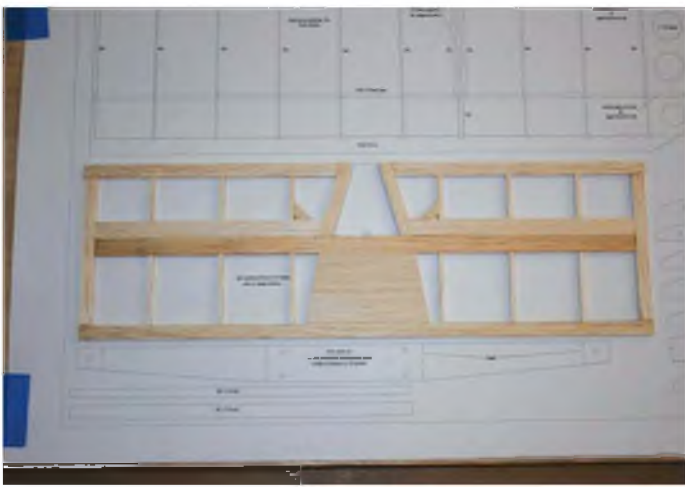

As you see, the tailplane and elevators couldn't really get much simpler. Fin and rudder are of very similar construction.



One top wing panel ready for trimming and sanding and a lower panel under construction. Just ensure you end up with a pair of each.



How the tail wheel leg is bent around the wheel and fits into the rudder to provide steering on the ground.

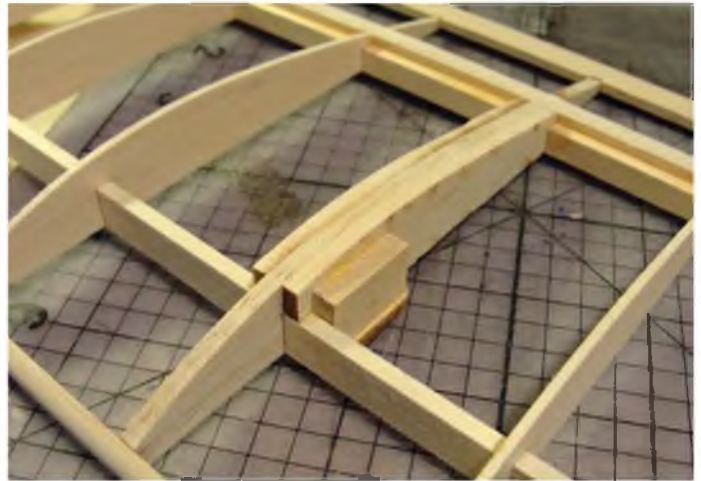

Despite the retro fitted aileron, this is a top wing panel. Note the strut socket and the hard point Alby fitted for diagonal strut attachment.

upper panels in the same way that the lower panels are built.

When building the lower wing panels, it is essential that you fit R6 and R7 in their exact correct locations. The reason is that the holes in the ribs, into which the carbon joiners will glue, are at differing heights within the ribs so that dihedral is set automatically as the wings are slid into position. The model won't look quite the same with dihedral on one lower panel and anhedral on the other. Probably won't fly quite the same either!

So, since they are the more complicated wings to build, let's take a look at the lower wing panels.

Begin by notching trailing edge parts to accept the ribs and trimming the spars to fit over the wing tip parts. Also taper the spar end from the most outboard rib position down to where the tip will be. Now pin down the tip, leading edge, spars and trailing edge pieces over the plan, gluing as required. Pin down the 1/8" balsa false trailing edge at the aileron position, gluing it to the rear spar. Also pin down, but do not glue the 3/16" balsa aileron leading edge. Glue in the wing ribs, ensuring that you lean in the root rib to provide dihedral. Glue in parts SS, H1 and the 1/8 balsa pieces either side of the servo bay.

Now, using some scrap 1/32" packing, glue in the ply rails to which the servo tray will attach. Sheet the root bay and allow the glue to dry before removing the wing

from the board. Trim and sand as required and you have a completed wing panel. Repeat the process three more times, either with or without the ailerons on two of the panels, but take care to ensure that you end up with matched pairs of wings, not two right hand panels with ailerons and two left hand ones without.

If you are adding ailerons to the upper wing, you'll need to make up a linkage between the upper and lower ailerons.

CENTRE SECTION

There's really nothing very complicated about building the top wing centre section (c/s). Pin down the leading edge and spars, glue the dihedral braces to the spars and glue in place the laminated parts CS. Allow to dry, trim and sand and then glue in place the top wing panels. That's it, your wings are now ready to cover.

TAIL SURFACES

If you thought the c/s was easy, you'll love the tail surfaces. These are simply built over the plans using the cut parts and 3/16" strip balsa. Allow to dry, sand and shape and join the elevators using the 16 swg joiner. Do note that you need to solder the internal elevator horn to the joiner BEFORE you glue it firmly into the elevators. It rather complicates matters if you join first and then try to fit the horn.

To install the linkage, attach the

pushrod to the horn and feed it into the fuselage as you glue the tailplane in position.

FUSELAGE

With the easy parts out of the way, let's take a look at building the fuselage. It's still not what you'd call overly complicated, but is slightly more involved.

Construction begins in the time-honoured fashion of building two identical fuselage side frames over the plan. You can either build the centre section struts into these frames, or fit them after the decking is installed. The slots in the sides will serve to ensure they go in upright, while the strut doublers will act as a guide to keeping them aligned with the lean on the fuselage sides. It all depends on whether you prefer not to have struts getting in the way while trying to fit the decking sheet.

Mark the inside of both fuselage sides with the former positions and the position of mount plate M. Pay attention to the fact that M is angled across the fuselage to provide side thrust. Now glue in the strut doublers and join the sides using F1, F2, F4 and UC. If in doubt about your landings, or flying from a rough site, reinforce UC with triangular stock in the corners between the part and the fuselage sides. Ensure all is square and allow to dry.

Next, fit M and the triangular brace pieces. Note that the small hole in M is not central, it indicates where the motor



A basic fuselage side under construction. Note the c/s strut slots and the exit hole for the aileron servo lead.



Working over the plan Alby uses the flat bottom of the former to assist with getting the u/c plate at the correct angle to the sloping fuselage side.

centres, allowing for down and right thrust, if the prop driver is to be central in the cowl.

It's a good idea to get your motor bolted in place at this point, while you still have plenty of access. If required, the cowl face, and even the lower cowl block may be made removable for motor access during the life of the model. Simple locating dowels and magnet retainers is a system that works well.

The next task is to pull in and join the tail. Whether you do that and then fit the formers and cross braces, or fit them as you pull in the tail is a matter of personal preference. Either method works just fine, but do take care to ensure that you end up with a straight, twist free fuselage. Once all the formers are in place, the forward decking and stringers may be fitted. Use some scrap spacers to support the tail blocks while you shape them and

then remove them until your tailplane is glued in place (otherwise you won't be able to fit the linkage for the elevators). Laminate and fit parts N and the lower cowl block and sand the fuselage smooth.

Note that two access hatches are shown on the drawing, but if you make the lower cowl block removable, and depending upon the size of your battery pack, the pack may use the block hatch for access and be mounted in front of F2.

The wire undercarriage may be shaped (or use a similar size commercial item) and bolted in place after the fuselage is covered.

COVERING AND FINISHING

Although there are a multitude of viable covering materials suitable for a model of this type, probably the most obvious is iron on film. However, never being one to take

the easy route, if memory serves correctly Alby chose to finish his model using laminating film and paint. Whichever system you use a little research will come up with some most attractive schemes - even if they aren't the scheme used on the prototype aircraft. Larry has demonstrated admirably that it doesn't take much modification to produce a model better suited to some of the more recent finishes.

Anyway, having covered your model with your favourite medium, and given it the colour scheme you fancy it's time to start getting the model together. Because of the self aligning nature of the structure this really isn't the chore it might be with a biplane.

Begin by sanding the bevel on each end of the interplane struts (inner face at the bottom tongue and outer face at the upper) so they will fit into the wing

The obligatory naked model shot reveals the simple construction that results in a very attractive model.



despite leaning outwards towards the top. Now glue the top wing onto the c/s struts, ensuring it aligns correctly. If your struts are accurately fitted and your fuselage straight and square, this should happen automatically. Allow that to dry and then slip the lower panels onto the carbon tube (or rod) joiners, gluing the root rib to the fuselage side. You will, of course, already have installed your aileron servos and extension leads, so the plugs should be fed through the holes in the fuselage sides as the wings are slid into place. Now, by gently springing apart the upper and lower wing panels the interplane (i/p) struts may be glued into their sockets.

Whilst the plans show a glued in place cosmetic diagonal strut made from wood, Alby fitted a strut made from streamline tube with the ends flattened and screwed in place. A functional strut isn't required, but it is an option.

With the wings accurately fitted, it's a fairly simple task to align the tailplane as you glue that in place. Once the tailplane is set, the balsa fairing blocks can be fitted and they will ensure that the fin stands a more than fair chance of aligning correctly.

All that now remains is to bolt the u/c in place, complete the linkages and ensure that the model balances correctly at the point shown on the plan. Personally, I like the model to balance just very slightly nose down when supported at the balance point. Whilst a slightly nose heavy model may not fly as well as one precisely balanced, it doesn't risk the perils of a marginal balance or a slightly tail heavy model. I once saw a comment that nose heavy models don't fly very well, but tail heavy models don't fly for very long - before turning back into a kit of parts, and am constantly aware of that when flying a model for the first time. Whilst you can always make minor adjustments to correct nose heaviness, you may never get the chance to correct a tail heavy model without a lot of repairs first.

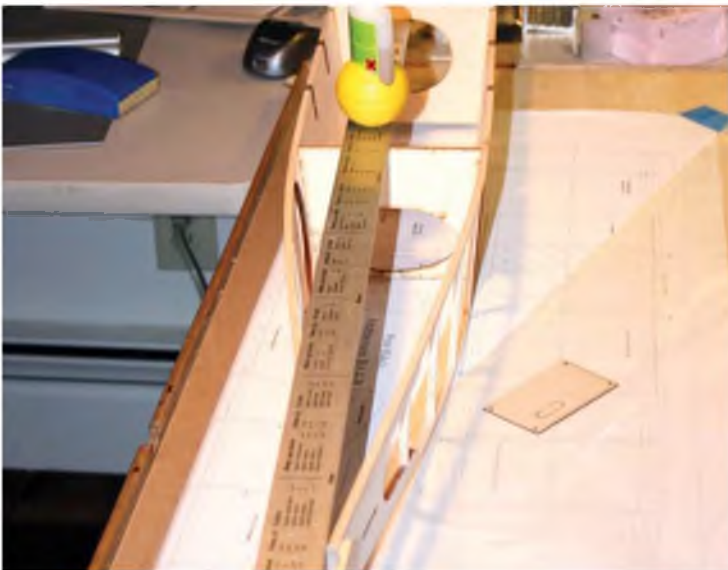

Working over the plan and using a rule aligned with former centres helps ensure a straight fuselage once the tail is joined.

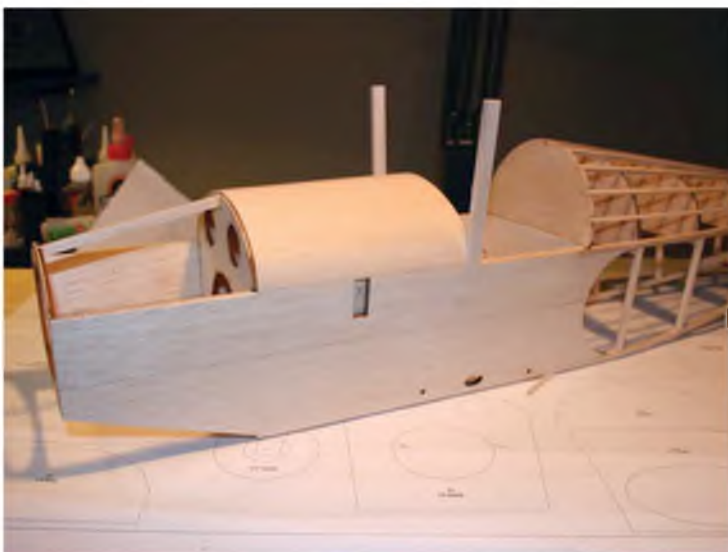

Here you see the already fitted decking being trimmed to allow the c/s struts to fit snugly in place.

CUT PARTS SET FOR THE

ANDRAESSON BA4-B

Get straight down to construction without delay! This month's full size free plan feature is supported by a laser-cut set of ready-to-use balsa and plywood components. This provides all the parts that, otherwise, you would need to trace out onto the wood before cutting out.

**IT DOES NOT INCLUDE STRIP
AND SHEET MATERIAL OR
SHAPED WIRE PARTS**

Price £49.00

plus carriage: £11.50 (UK); Europe £26.00

Order set CUT/FSM515

Shipping Note: For shipping to destinations outside the UK and Europe, you will be charged our standard flat-rate price of £49. This covers most destinations and secures your order with us. However, we will contact you accordingly with an accurate total shipping charge prior to dispatch and either issue a refund or a PayPal money request for the balance.

Visit our secure website:

www.flyingscalemodels.com

to order yours



Order direct from:- ADH Publishing, Doolittle Mill, Doolittle Lane, Totternhoe, Bedfordshire, LU6 1QX, UK. Tel: 01525 222573/
enquiries@adhpublishing.com.



Note the packing pieces used to support the tail blocks during shaping and sanding.



How the tail surfaces will fit once the packing pieces have been removed.



How that diagonal strut goes. In this case screwed in place streamline tubing.

So, it's well worth spending a bit of time to ensure you don't end up with a tail heavy model. After taking the care to build the model correctly it has to be a worthwhile use of time. It's surprising how many builders, even experienced modellers who should know better, fall into that trap. Often with quite interesting results when they attempt to fly the model. Interesting, but not actually that desirable and definitely not enjoyable.

FLYING

Rather than simply tell you how the model should fly, I'll simply quote what Alby said about the maiden flight of his model.

"Effortless is the best way to describe the maiden flight. I took the BA-4b out to a local High School field this morning full of Rake plane confidence - and was not disappointed!

With the plane set down facing the smoothest ground trajectory available, I throttled up, the aircraft advanced & the tail came up (very quickly) - she simply levitated on a gentle & smooth skyward flight path. Having not flown in awhile, I felt it wise to leave the upper ailerons disconnected for the first few flights. Therefore, aileron response is what I would call adequate. A couple clicks of elevator and aileron and she was floating around beautifully. Beautiful enough to bring her down within a couple of feet off the ground for some up close appreciation in the still morning air. That same still morning air was about 24 degrees F which limited flight time to about 5 minutes. During the flight, I managed a few loops and very lazy rolls. She is very gentle, with a fast recovering stall and really no bad habits. As with any worthwhile plane, rudder was required to coax proper turning. Landing as

you might have guessed by now, went smoothly as well. Throttle control alone set her down on the mains with a nice rollout. I look forward to taking her out often - its the kind of plane you want to shoot touch and goes with until the cut-off interrupts." ■

MODEL SPECIFICATION

- Motor:** E-FLite Park 480 (lower kV version)
- Speed control:** Great planes Silver series Brushless 35A
- Battery:** Thunder power 2100mah 3S "pro-lite"
- Receiver:** Spektrum AR 500 Sport
- Servos:** Hitec HS-55's all around
- Prop:** 11X4.7 (may swap out for slightly more pitch - better than 1:1 thrust though)
- Weight (current):** Approximately 32 ounces "all-up"

The model reveals the little cockpit detail Alby fitted as it climbs away from take-off.



Radio Control DroneZone

Only £4.99
(in the UK)



Radio Control Drone Zone

Into quadcopters, hexacopters, octacopters, UAVs or drones? Fancy having a go at FPV racing? Want to master aerial photography or filming? Need help building or setting up your multi-rotor? Confused about which model to buy? Worried about staying on the right side of the law? Then you need a copy of the latest Drone Zone from the publishers of RC Rotorworld, the UK's best-selling model helicopter magazine.

Due to the overwhelming success and popularity of the first special issue published earlier this year, we have made the very easy decision to turn Radio Control Drone Zone into a regular, bi-monthly addition to ADH Publishing's portfolio. Drone Zone will offer expert buying advice, reviews of the latest machines and accessories, tips on where and how to fly safely, in-depth features on aerial photography and video, build tips and technical articles, as well as general features on subjects including GPS, FPV and electronic systems. Regular features will include:

- New product reviews
- Buyer's guide to the latest models
- Technology features on FPV and aerial photography
- Building your own drone from scratch or kit
- Drone dictionary with a full list of words, acronyms and terminology
- Plus, experts tips on drone dos and don'ts, safety advice, staying within the law, setting up and how to fly

With all this focused content and more, Drone Zone is a must buy special for all UAV, drone, quad and multi-rotor enthusiasts. The next issue (Dec/Jan) will go on-sale Thursday 12th November. For more details visit the ADH website at www.adhpublishing.com/shop/store/products/drone-zone-special-edition

NOW bi-monthly



SUBSCRIBE NOW ON TEL: 01525 222573 FAX: 01525 222574

DRONE ZONE

Name.....
Address.....
.....
.....
Post/zip code.....
Country.....
Telephone Number.....

Please debit my credit/debit card for £.....
 Visa Mastercard Maestro other.....
 Card No.....
 Expiry date..... Start date.....
 Security Number (last 3 digits on signature strip).....
 Issue No (if applicable).....

Single Issues
UK: £4.99 inc p&p
Europe: £6.99 inc p&p
World-Wide airmail: £7.99 inc p&p
6 issue Subscription
UK - £26.00 inc p&p
Euro - £38.00 inc p&p
WW - £43.00 inc p&p
 Cheques payable to: ADH Publishing Ltd.

Signature.....
Date.....

Please mail this form to:
 ADH Publishing, Doolittle Mill, Doolittle Lane, Totterhoe, Bedfordshire, LU6 1QX, United Kingdom
Tel: +44(0)1525 222573 Fax: +44(0)1525 222574 Online: www.adhbooks.com
 (Photocopies of this form are acceptable)



Yes, I'm afraid it's that flippin' man again, come to bend your ear with more electric flight goings on. Since by now you'll almost certainly have a slightly the worse-for-wear micro foamy on you hands, and nobody has sent me the innards, I'll have to assume you're all itching for the second instalment of the DH6 plan and article we began last time. Well, I can't think of any other reason that you haven't donated the equipment to such a worthy cause - which I suppose means I'll have to buy my own micro gear then! Life can be just so unfair sometimes. Not, of course, that there's anything unusual in that situation.

Those of you who think this column-writing lark is a sure route to an endless supply of freebies had better think again, it's nothing of the sort. Or maybe I just write for the wrong magazine? No, perish the thought, there is no better magazine than dear old FSM.

WHERE DID WE LEAVE THINGS?

Oh yes, you had the fuselage plan for the DH6 and I'd rambled on for a bit about covering options, without actually getting as far as doing any building. Oh all right then, without detailing any of the building done by Larry Nagel and Tom O'Meara. They, in case you'd forgotten, are the two builders who kindly offered to prototype this design for me and supply me with all sorts of interesting photos to illustrate the process.

PETER RAKE OFFERS THE FINAL PART OF HIS FULL SIZE PULL-OUT PLAN FEATURE FOR A NEAT LITTLE 18" WINGSPAN DE HAVILLAND DH6, WITH THE WINGS AND TAILPLANE

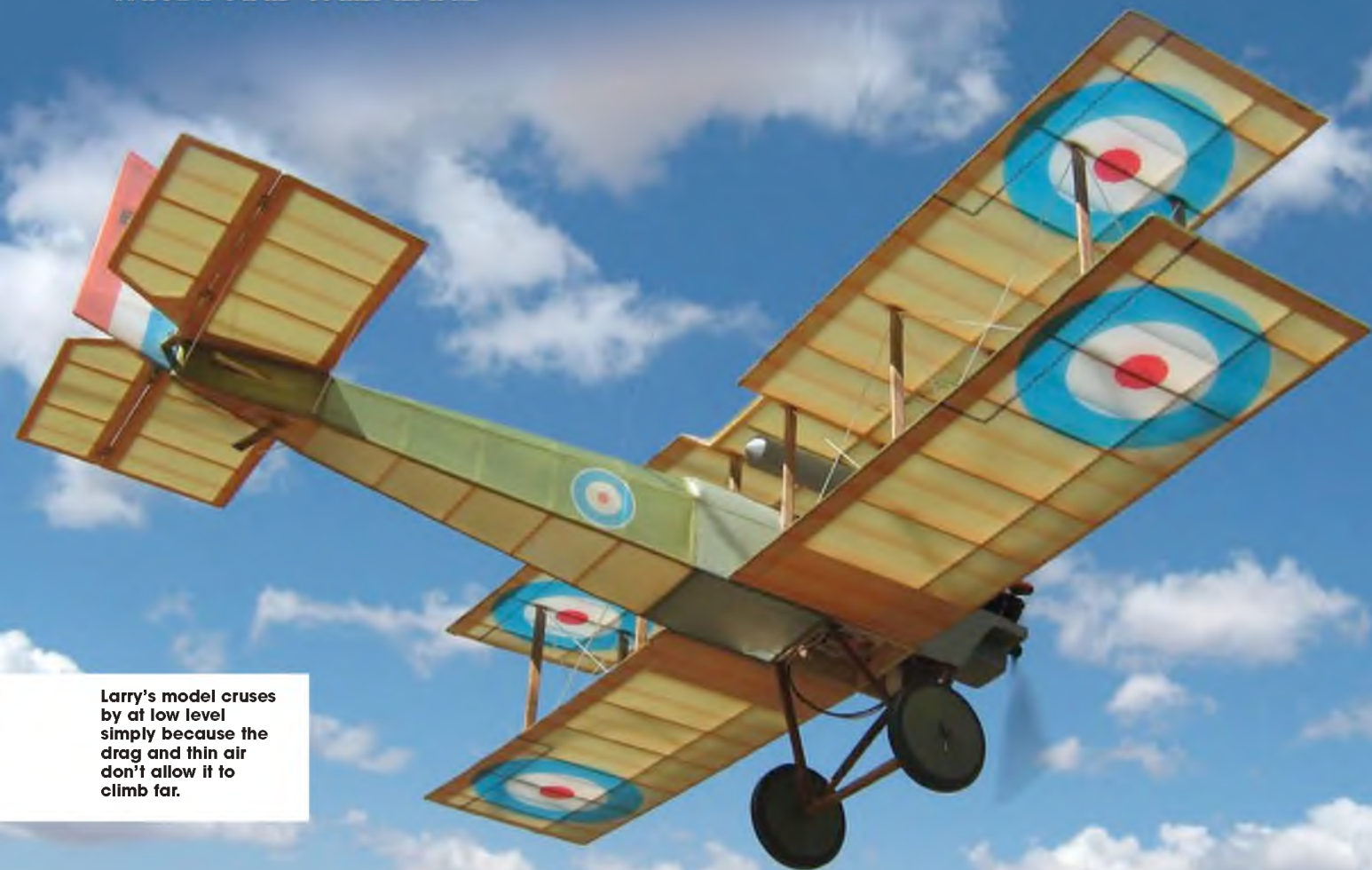

Larry's model cruises by at low level simply because the drag and thin air don't allow it to climb far.

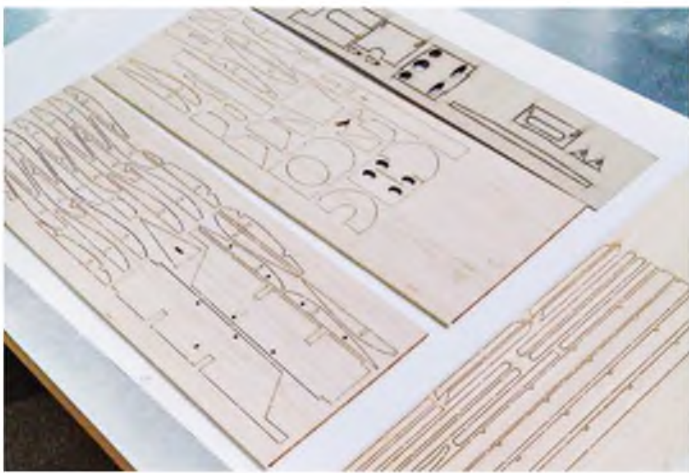

As you can see there aren't many parts to cut for this model, although these ones are laser cut.

Larry cut his own parts and here you see all four wing panels and the c/s assembled and drying.



Tom's assorted fuselages using differing motor units, radio positioning and laminating film covering. Note that Top opted for upper decking hatches on his models.

That being so, I suppose it's time to get on with some actual building.

EASY PEASY

As intimated last time, there's absolutely nothing involved here that won't come as second nature to anyone in the least familiar with building rubber power models. After all, the whole idea behind the model is that it should be a sort of reinforced rubber power model, adapted to electric power and radio control. Since it is such a straightforward model to build I won't bother with a blow-by-blow description (for which there isn't room anyway) and will just highlight any points that I think might cause a little head scratching.

Starting with the fuselage you'll notice there are a couple of points at which the sides break sharply inwards, one where the sheet sides end and one at the tail. Larry had built one of my designs before and knew how the forward break was achieved, Tom hadn't and didn't. Consequently, Larry built the fuselage as two sections (a sheet sided one and one built up from strip), while Tom built continuous sides. Either method will work,

but having to crack the longerons immediately aft of F4 strikes me as a practice fraught with peril. It's at just the point most likely to suffer damage in the event of an unpleasant 'arrival'. The crack in at the rear has never posed a problem on dozens of models because it is supported by both the tailplane and part TS being glued to items in front of the break.

So, my advice is to build the fuselage box as two sections which are then joined over the plan (to keep things straight). The longeron stubs that now protrude past the sheet sides can easily be sanded flush and serve to reinforce that point.

Although the c/s struts may be built into the basic fuselage sides, as done by both builders, but because of the doublers it is possible to install them after the forward decking is in place. If the parts are accurately cut and assembled the fuselage side slots will prevent forward/backward divergence, while the doublers help prevent any lean inwards or outwards. This does, of course mean that the fuselage can be virtually completed, and the decking all sanded

before you trim the decking to clear the struts and glue them in place.

MOVING ON

You'll notice that the wing trailing edges are shown as bass and there is a reason for this. Because they can be so easily distorted by the covering I felt a little extra strength in this area would be in order. Yes, hard balsa would suffice perfectly well, but since the parts form part of the laser cut items, I can't guarantee that they would in fact be cut from hard balsa. Soft balsa would be hopeless in this area, so bass it is.

Other than that point, building the wings should pose no problem at all. Make up the strut sockets as indicated on the plan, but do try (if not using laser cut parts) to ensure that the rib cut-outs and the strut ends are exactly as shown, so that they fit snugly when you assemble the model.

If you need help building the tail surfaces then it's highly unlikely that you will have got this far since they are absolutely the simplest parts of the entire model.

FITTING OUT

There are a multitude of ways of producing the pushrods required and our intrepid test

angle all root ribs for dihedral

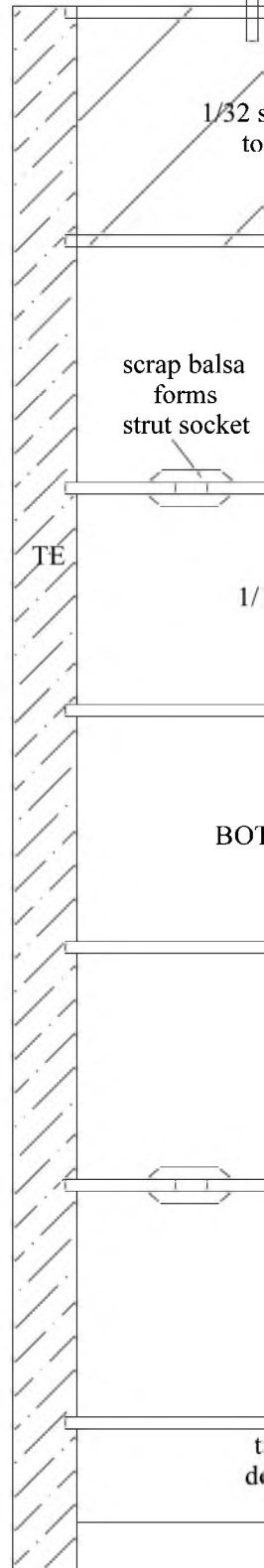
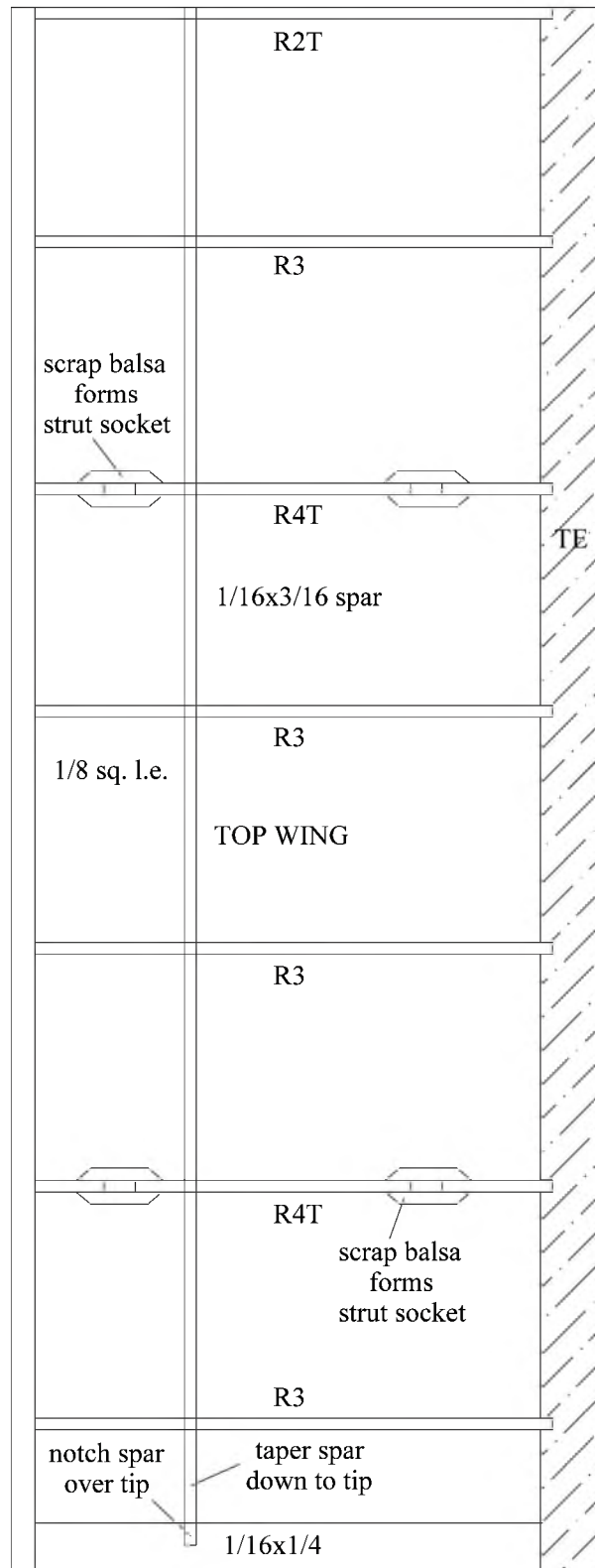
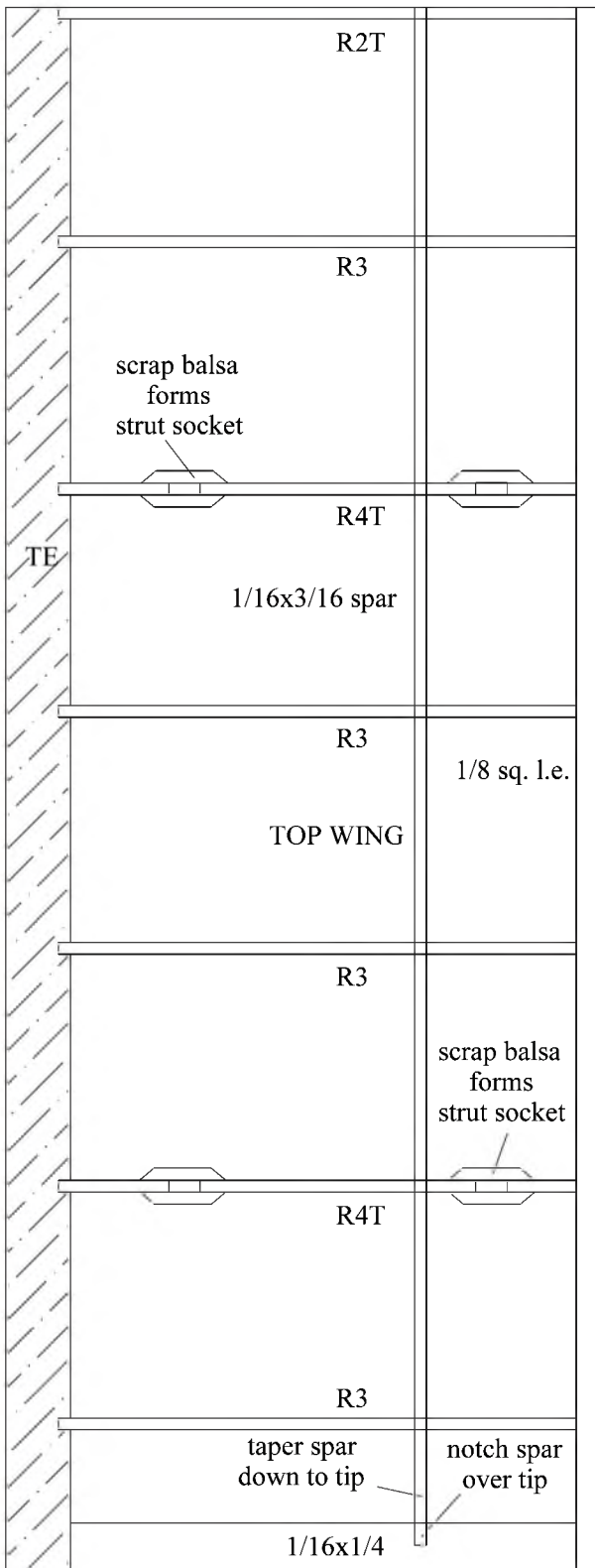

0.5" dihedral under tip
all wings

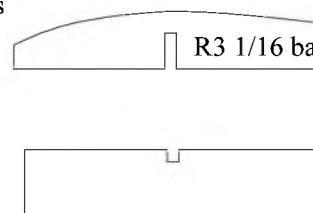
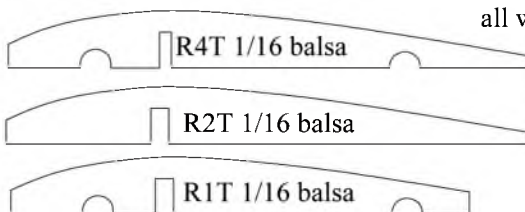
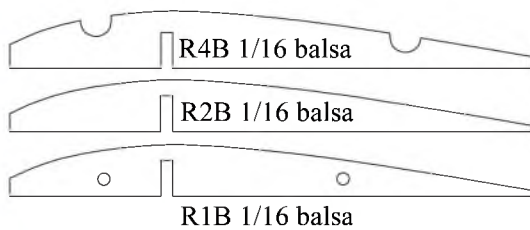

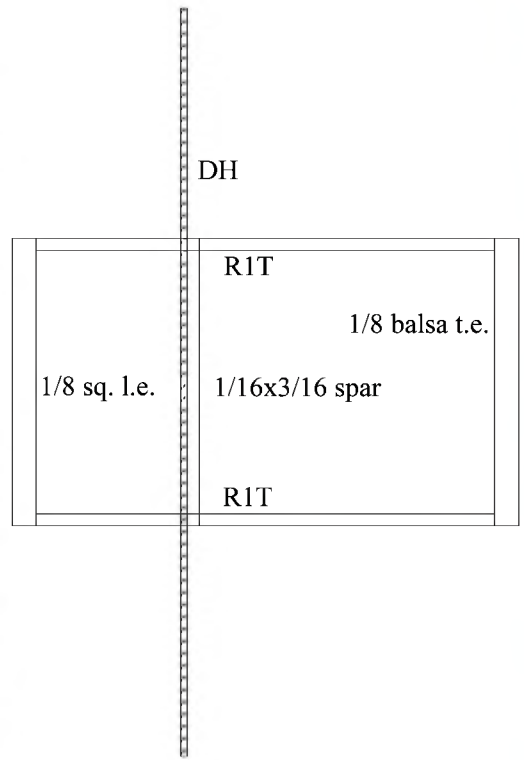
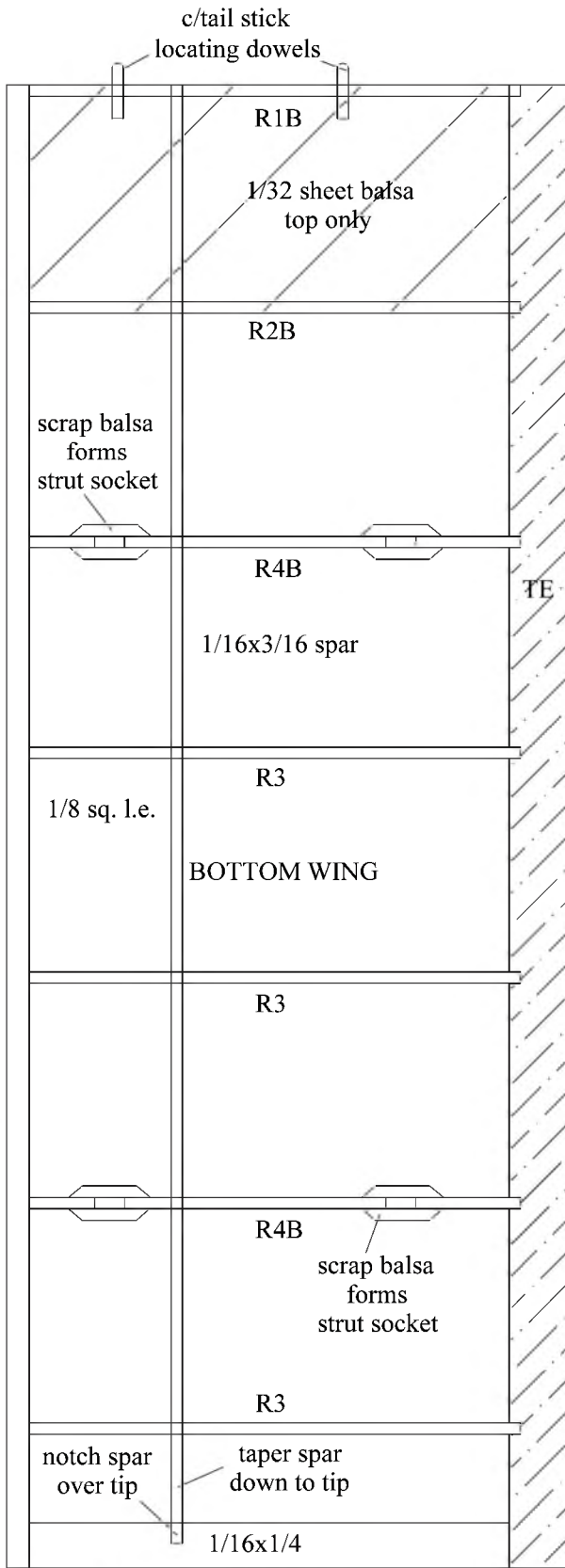
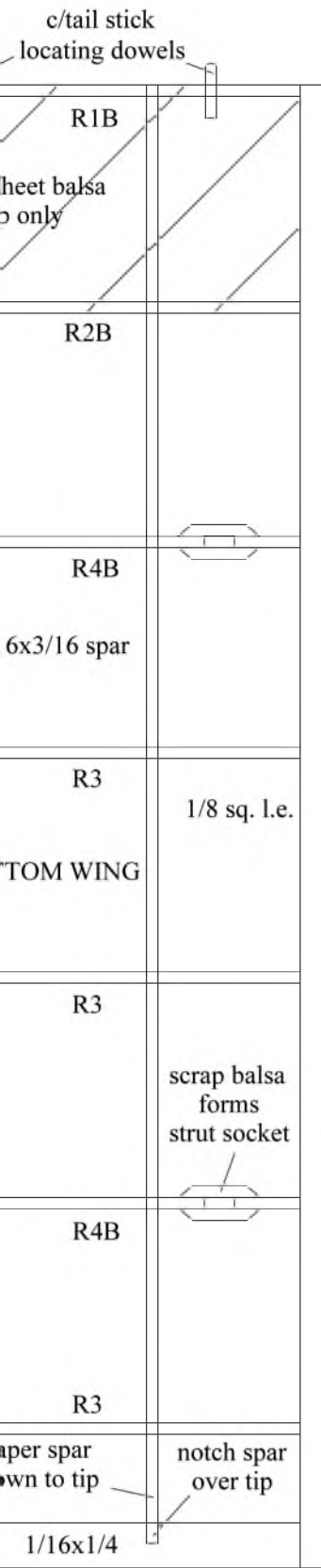

Peter Rake's
DH 6
 "Clutching Hand"
 Copyright P. Rake 2015

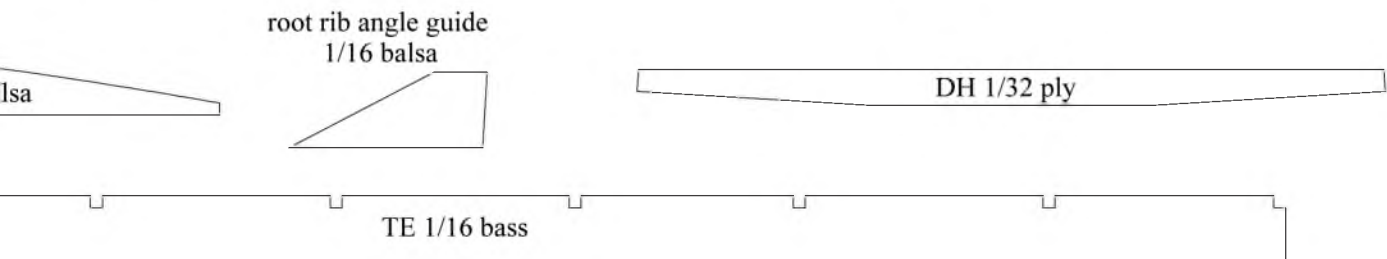

Minimal detail on Tom's model makes it less inclined to handling damage and the laminating film covering makes it tough.



The obligatory naked model shot reveals the simple construction of Larry's model.



This shot should reveal just how much drag Larry built into his model. That enormous scoop must gather in a lot of air.



Larry's very 'old school' pushrods and the easy to access receiver brick. What ever you do, keep glue and grit away from those servo gears.

builders used slightly different techniques. I'd use carbon rod (1mm) with wire ends retained by heat-shrink tube and a spot of CA. Larry went very 'old school' and used strip balsa with wire ends bound and glued in place, while Tom opted for a sort of in between system using stripped bamboo as the basis of his pushrods.

Whichever method you use, it is important to get the receiver brick positioned precisely as shown on the drawings. I went to a lot of trouble to ensure that those exit plates actually do align correctly, but they only work if the receiver is exactly where it's shown.

Because everything needs to be fitted from below, it's well worthwhile leaving the fuselage bottom uncovered until you have all the equipment in place. Then, if you want to cover over the receiver you can, but the front bay (between F2 and F3)

should be left open for easy battery access. Larry used a 'standard' style Parkzone style battery fitted vertically in front of F3, with the connector and lead protruding below the fuselage, while Tom used the wider and shorter, but heavier MCX style battery and made the forward section of decking a hatch.

PROOF OF THE PUDDING

As mentioned earlier, Larry encountered a few problems with his model. However, you have to take into account that his motor wasn't new, he had a lot of built in headwind (drag) and that his flying site is at roughly 5,000 feet above sea level - so the air tends to be on the thin side. This combination of unfortunate events meant that although his example flew in a steady and stable manner, he was constantly at full throttle to maintain around 20 feet of height

and tended to lose height in turns.

When you look at his model it isn't too hard to see what might well be his biggest problem - that scale-like scoop at the nose. It must be like flying with air brakes permanently deployed.

Tom, on the other hand, with his much cleaner model encountered no such problems. Although it was slightly breezy when he made his first test flight, the little model flew well from the outset and coped surprisingly well with the wind. It also managed to survive (unscathed) being blatted into the ground by an unruly gust.

Subsequent flights only confirmed his first impressions. The model is stable in the air, has ample power for its' roughly 3 ounce flying weight and responds nice and smoothly to control inputs. ■

NEW in the 'HOW TO BUILD...' series



NOW AVAILABLE
Order Now

NEW How to Build the Tamiya 1:32 Mosquito FB.VI

The definitive guide to building the much anticipated Tamiya 1:32 Mosquito FB.VI by Brett Green.

This book features a comprehensive build plus:

- Mosquito restoration close-up
- Historical summary
- Wartime reference photos
- Step by Step - Tips and techniques for building the ultimate Mosquito
- The other Tamiya Mosquitos in 1:72 and 1:48 scales
- Aftermarket decal and accessory summary

NOW SHIPPING

Only
£13.95
plus p&p

ALSO AVAILABLE Visit adhbooks.com for details



PLACE YOUR ORDER NOW ON **TEL: 01525 222573** **FAX: 01525 222574**

Tamiya's 1:32 Mosquito FB.VI book

HOW TO BUILD... MOSQUITO

Name.....
 Address.....
 Post/zip code.....
 Country.....
 Telephone Number.....

Please debit my credit/debit card for £.....
 Visa Mastercard Maestro other.....
 Card No.....
 Expiry date..... Start date.....
 Security Number (last 3 digits on signature strip).....
 Issue No (if applicable).....

P&P: UK: £2.00
 Europe: £4.00
 World-Wide airmail: £6.00
 Cheques payable to: ADH Publishing Ltd.

Signature.....
 Date.....

Please mail this form to:
 ADH Publishing, Doolittle Mill, Doolittle Lane, Totterhoe, Bedfordshire, LU6 1QX, United Kingdom
Tel: +44(0)1525 222573 **Fax:** +44(0)1525 222574 **Online:** www.adhbooks.com
 (Photocopies of this form are acceptable)

www.adhbooks.com www.adhbooks.com www.adhbooks.com

Techno Scale Mike Evatt sta

Elite Models Online Ltd have an extensive web presence at www.elitemodelsonline.co.uk. They stock an amazing selection of kits and ARTF models. One of their IC powered offerings is the Seagull Pilatus PC9 Roulette. The PC-9 is a single-engine, low-wing tandem-seat turboprop training aircraft manufactured by Pilatus Aircraft of Switzerland. This model has a 154cm wingspan and is designed for 40-46 two-stroke or 52 four-stroke IC engines. It is factory covered in Oracover in the colours of the 'Roulettes', the Royal Australian Air Force's formation aerobatic display team. www.jmajets.co.uk is the URL of **Jet Modeller's Association's** webpages. The JMA was established in 1995 and is the specialist body to promote interest and participation in the sport of design, construction, and flight of jet type model aircraft in Great Britain, and is represented on the BMFAs R/C Power Technical Committee and on the Board of the International Jet Modeller's Committee. The Association is managed on a day-to-day basis by a Committee who are all

current practising jet modellers. The website contains membership details, lists of forthcoming events and links to other jet related sites.

I always have a soft spot for classic seaplanes and the Macchi Castoldi M.C. 72 in particular. The screen shot shows the **SebArt** version, which is available from Dumfries Model Flying at www.dumfries-model-flying.com. The Macchi M.C. 72 was one of a series of seaplanes developed by Macchi Aeronautica and designed by Mario Castoldi and held the outright world speed record for all aircraft for five years. In 1933 and 1934, it set a world speed record for internal combustion-powered seaplanes that still stands. The model version is electric powered, is ready to fly and evokes all the magic of the original.

The **Anglia Model Centre** has been in the model business for over 35 years, it is based in Gorleston UK and now has a significant on-line presence at www.angliamodelcentre.co.uk

What I found here is something of a novelty. A Grumman F-14 Tomcat for

rubber power! This Guillow's kit is for those who delight in building flying lightweight stick and tissue models of favourite scale subjects. However the delta wing planform may make it a little tricky to trim.

Since 1964, **Hobby Express** has offered quality products supported by outstanding service to their customers. The company also designs, manufactures and distributes radio control aircraft, drones and highly reliable quality electronics as well as stocking third party models and kits. Such as the FMS North American B25 Mitchell, FMS has chosen the B25-D which featured upgraded supercharge radial engines and increased armament and first flew in January 1942. This is a highly detailed and feature-rich model which includes: seven painted pilots, 11 machine guns, high power LED Navigational lights, worm drive retracts with gear door sequence controller.

Check it out at www.hobbyexpress.com. **Phoenix Model** at www.phoenixmodel.com has specialized in designing and manufacturing ARF R/C model aircraft since 1991. Today, they



Seagull's Pilatus PC9 Roulette from Elite Models Online Ltd.



The Jet Modeller's Association's webpages.



A SebArt Macchi M.C. 72 available from Dumfries Model Flying.



A Grumman F-14 Tomcat for rubber power!

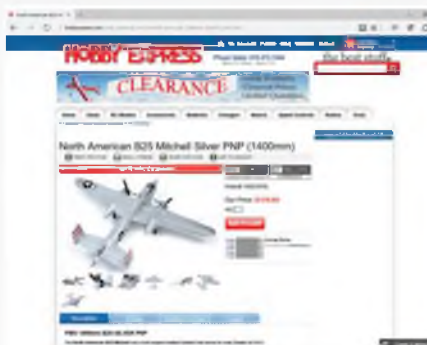

Hobby Express offers a fine North American B25 Mitchell.



This 6 meter span Ka-8b Glider is equally at home on the slope or aerotow.

talks cyberspace for more TechnoScale Topics...

claim to be the largest and most experienced manufacturer in Vietnam. Phoenix Model has introduced the Ka-8b SLS, a scale 6 metre span sailplane designed with the sport enthusiast in mind. Built by expert craftsmen, this top-quality balsa/ply glider is covered in Oracover for a durable and attractive finish. Although it is supplied with electric power the Ka-8b Glider is equally at home on the slope or aerotowed using its releasable tow hook.

Through common sense and good engineering, **Leading Edge Gliders** is "raising the bar" on EPP gliders. They claim that their attention to detail separates their high performance EPP Slope Gliders from all others. Look at their wares at <http://leadingedgegliders.com> Leading Edge Gliders' 60" wingspan version of the A-10 Thunderbolt (Warthog) features fiberglass-like performance combined with the durability of EPP foam.

The **Rocky Mountain Aeromodelers** is a Denver based Control Line Club chartered by the Academy of Model Aeronautics. It is a not-for-profit organisation dedicated to the sport known as Control Line Model

Aviation. The RMA are celebrating their 41st anniversary as an AMA member and their website at www.eicnetwork.com shows that control-line is alive and well in Colorado! It also shows there is keen interest in both Scale and Carrier disciplines and has good information and articles regarding Electric powered control-line.

www.bathmhc.co.uk is the web address of **Bath Model Helicopter Club**. This is a helicopter only club located to the west of Bath with members ranging from novice beginners to competition 3D pilots. All types of helicopter are flown including: electric, nitro, petrol & scale models and they hold regular events, meetings & club days throughout the year. For those thinking of taking up scale helicopters there is a very good section covering how to get started.

Finally! Two more museums to visit on those un-flyable days!

The **Museum of Army Flying** at www.armyflying.com is home to a unique aviation collection, one of both national and international importance. On display

are over 35 historic fixed and rotary wing aircraft spanning more than 100 years of flight in the British Army. Together with detailed dioramas, artefacts, trophies and models, these serve as profound and inspiring tributes, helping to tell the story of the 'soldiers of the air'. The Museum gives a fascinating and imaginative glimpse of the men and women who have allowed the Army to be airborne, their machines, their achievements, lives and history.

The **Midland Air Museum** at Coventry UK as it is today represents many years of dedicated commitment by volunteers and staff who have helped to establish one of the country's leading self-funded independent aviation museums. The Museum houses a unique collection in the Sir Frank Whittle Jet Heritage Centre, of aircraft, engines and supporting exhibits illustrating the fascinating story of the jet age. The story of Whittle's jet engine is told in pictures, video and artefacts including an animated display. Check its on-line pages at www.midlandairmuseum.co.uk ■



Leading Edge Gliders' 60" wingspan version of the A-10 Thunderbolt.



Scale Control-line action in Denver.



Bath Model Helicopter Club's website is useful for the scale novice.



The Museum of Army Flying is home to a unique aviation collection.



The Midland Air Museum at Coventry houses the Sir Frank Whittle Jet Heritage Centre.



That's all there is time for from me this month so tickle the tablet and if you find something out there of interest that might be good to share, email me at:

mikeevatt@hotmail.com

DHC-2 BEAVER

BUSH PLANE WARRIOR

The DHC-2 Beaver was originally conceived as a rugged civilian monoplane. Expressly designed to meet the varied needs of bush pilots and the Canadian Forestry

Department, the Beaver was to be equipped with formidable power to ensure a brisk STOL performance. From the outset, the all-metal Beaver was developed to take a normal wheeled

undercarriage, snow skis, or floats. Adding skis was known to compromise an aircraft's cruising speed, but as one bush pilot allegedly remarked, the new Beaver only had to go faster than a dog sled!



VER

Andreas Engel's massive all-metal DHC-2 wowed the crowd at LMA Cosford 2015

Versatility was a key design concept. Practical issues, such as full size doors either side, allowed floatplane variants to load no matter to which side of the dock they were moored. Also the large doors

were made big enough to roll a 46 gallon fuel drum aboard. DHC was still British-owned when the Beaver was conceived, and a British power plant was chosen. This original engine proved no ball of fire, so

the new design's wing area had to be substantially increased. However, Pratt and Whitney made DHC an offer they could not refuse on WWII surplus 450hp Wasp radial engines. The net effect was a

“ The glazing is the most convincing that I have ever seen on a model aircraft ”



1: The panelling, apertures, and fenestration are immaculate.

2: Body of cabin is exactly like the real thing. Kit uses pressing for the formed corners of the cabin.

3: High visibility nav. light on its fairing.

4: One of the most interesting parts of this model model for any true anorak: the complex escutcheon below the windscreen!



greatly improved STOL performance. The Beaver first flew in 1947 and soon became the definitive bush plane. Her appealing no-nonsense looks endeared her to pilots and passengers alike. Production finally ceased in 1967. In all 1,657 examples were produced. The design was further developed into the DH-3 Otter.

The Beaver was so popular that existing US laws concerning the procurement of foreign military equipment were relaxed in favour of her importation. The Americans went on to buy 968 examples. Even the British Army Air Corps operated Beavers in Northern Ireland. These were used on

photographic surveillance duties. One such Beaver came under machine gun fire from a remote IRA checkpoint. Henceforward, Army pilots instantly dubbed that location "Beaver Junction".

The Model

Andreas Engel made a very bold scale statement when he flew this enormous 1:2.5 scale model at LMA Cosford 2015. LMA pilots and crowd alike stood and watched in delight as she flew over. She was built by Andreas's friend, Manfred Schimmel, from the amazing Harald Müller *MHM Scale Aircraft* kit. Her vital statistics are astonishing. She is 5.85 metres

Difficult to believe that this DHC-2 is a model.





This gives some idea of the extent of the panel-for-panel reproduction in the kit.

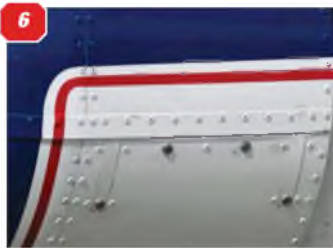

in span, (230") 1.27 metres (50") in height, and a full 2.69 metres (206") long. She weighs 92 kgs (202 lbs), and has over 12,000 rivets in her metal airframe. She is powered by a superb Vallach five cylinder R5-420cc radial petrol engine driving a 40"x18" prop, and the sound is

incredible. Throaty and rich, with superb prop noises on the turns. Flying speed falls within the 20-60mph range.

The Kit

Harald Müller, proprietor of *MHM Scale* in Ludwigsfelde Germany designed the

Beaver on a 3D CAD system. Harald was in possession of the manufacturer's data, plus he could go to Tempelhof airport to take measurements directly from the preserved example which is owned by the Deutsche Technik Museum. The whole model uses many of the same processes

5: Cowl air intake detail is astounding. **6:** Cowl edging is superbly realised, as are the working fastenings and general fits-and-finish. **7:** Close up of the wing-strut termination and fasteners. Note superb door hinge. **8:** Detail upon detail: fastenings, rivets, panel lines, clevis, under cowl, general operational grime! **9:** The double overlap of cowl and cowling is superb. Detail on the cowl itself is impeccable. **10:** Vallach 5-Cylinder R5 420cc four stroke 23hp radial on its 40"x18" prop.



11



11: Beautiful wheels, and the inflatable tyres sag nicely.

12: Authentic metal undercarriage and fairing accurately models the original. Note strut termination.

13: Rubber gaiter on undercarriage has not been forgotten.

14: Steps on the undercarriage strut fairing. They are non-slip!

12



13



14



used in the fabrication of the original. However, Harald's innovative techniques included the cutting of some metal parts with modern laser and water-jet cutting systems.

Besides this, the kit uses a large number of hand-crafted components. These include the development from sheet metal of the engine cowling, the wing tips, and the rear fuselage cone. The wings and flying surfaces are assembled using special jigs and all the metal frames are welded up, with added precision anchor points for fastenings, ensuring that the final assembly is true and square.

The model uses more than 1,000 parts and uses an astounding 12,000 rivets. Even the undercarriage is welded up, giving a tough metal structure. It is noticeable that when she is parked out on the grass, she sits on her wheels with the correct amount of bulge in her tyres.

The glazing is the most convincing that I have ever seen on a model aircraft,

the cabin access doors are exquisite, and the cowl is an anorak's delight. She looks every inch the real thing, and that rivet detailing has to be seen to be believed. I do not know of a more impressive kit.

Flying Notes

There was a troubling cross-wind at the 2015 LMA Cosford Show. Andreas had to use a boot-full of rudder during take-offs, and also had to hold her down until enough forward momentum had been achieved. Since she is essentially a scaled-down metal analogue of her full size sister, she looks utterly convincing in flight. She also possesses that certain 'gravitas' that comes with a faithful large flying scale model. She is not disturbed by gusts, and turns are appropriately proportional. There is no need to suspend disbelief. She is the real thing, just a bit smaller. Low passes are utterly majestic, and approaches and touchdowns are unflustered. All in all, this is a fully functioning scaled-down DHC-2. ■



15



15: DHC-style fin is work of art, as are the pressed metal corrugations. **16:** RCME scale columnist Danny Fenton would feast on this rivet detail. **17:** Authentic logos are printed and vinyl cut. **18:** Note hinges, corrugation details, trim tabs, and base of fin. **19:** Note mass balanced tailplane, trim tab, and tailcone fairing.

18



19



SPECIFICATIONS:

MHM Scale Aircraft DHC-2 Beaver

Scale: 1:2.5

Wingspan: 5.85m

Height: 1.27m

Length: 3.69m

Weight: 92kgs

Engine: Vallach 5-Cylinder R5 420cc four stroke 23hp radial

Prop: 40"x18" typical

Speed range: 20-60mph

Rivets: 12,000 approx.

CONTACT DETAILS

www.mhm-scale-aircraft.com

Price on application.

16



17



Convincing low pass.

LANDPLANE USED BY THE ROYAL CANADIAN MOUNTED POLICE

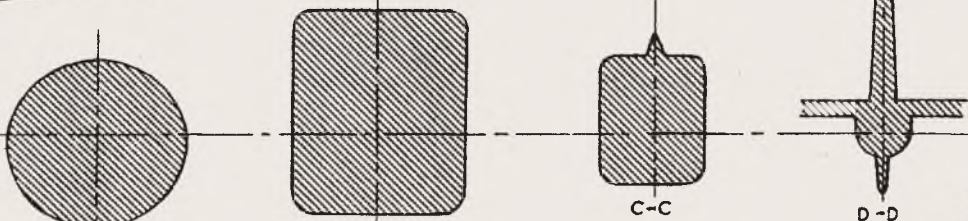
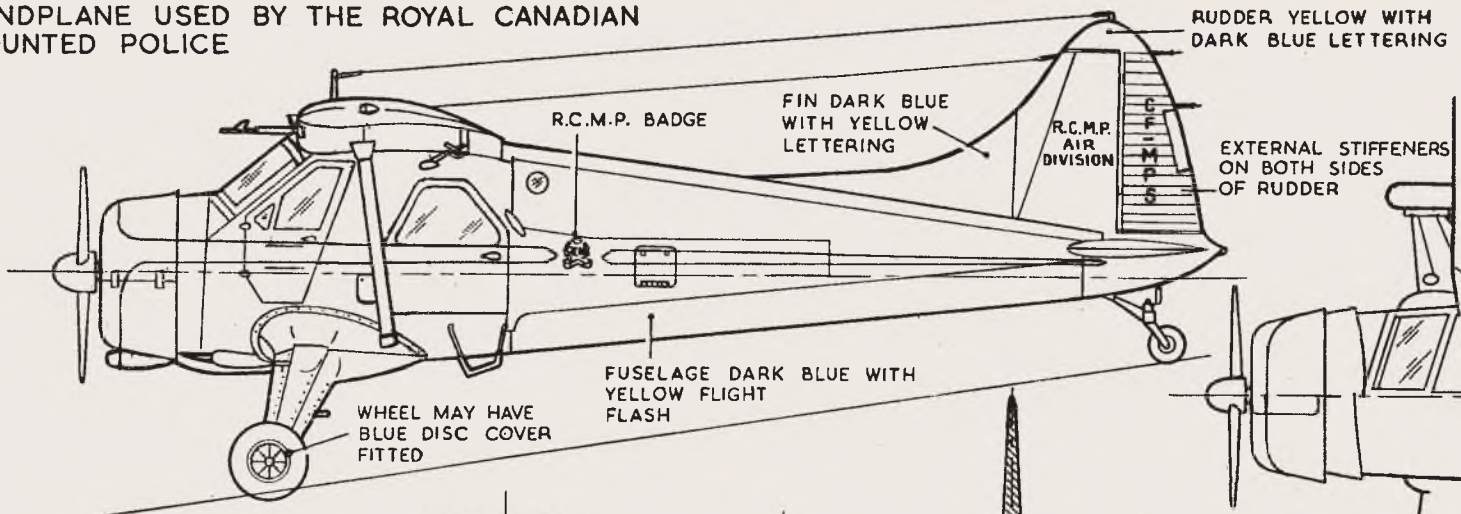

SEAPLANE USED BY A PRIEST MISSIONARY IN THE CANADIAN NORTH-WEST TERRITORY

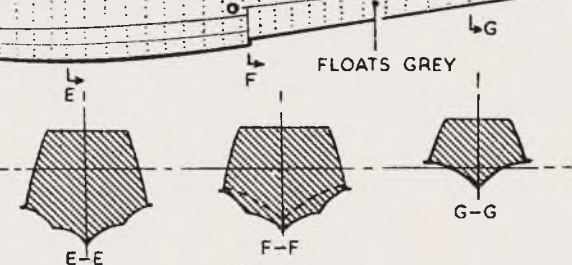
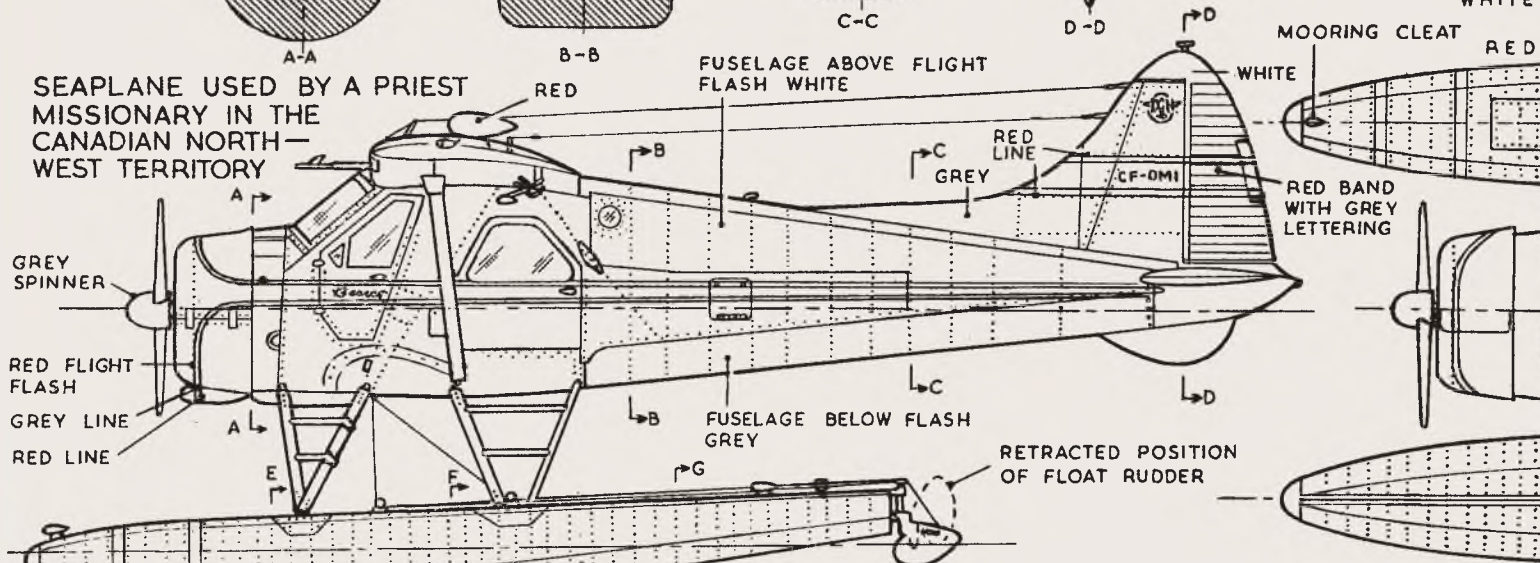

SKIPLANE USED BY "WARDAIR" IN WINTER - CONVERTED TO SEAPLANE REST OF YEAR

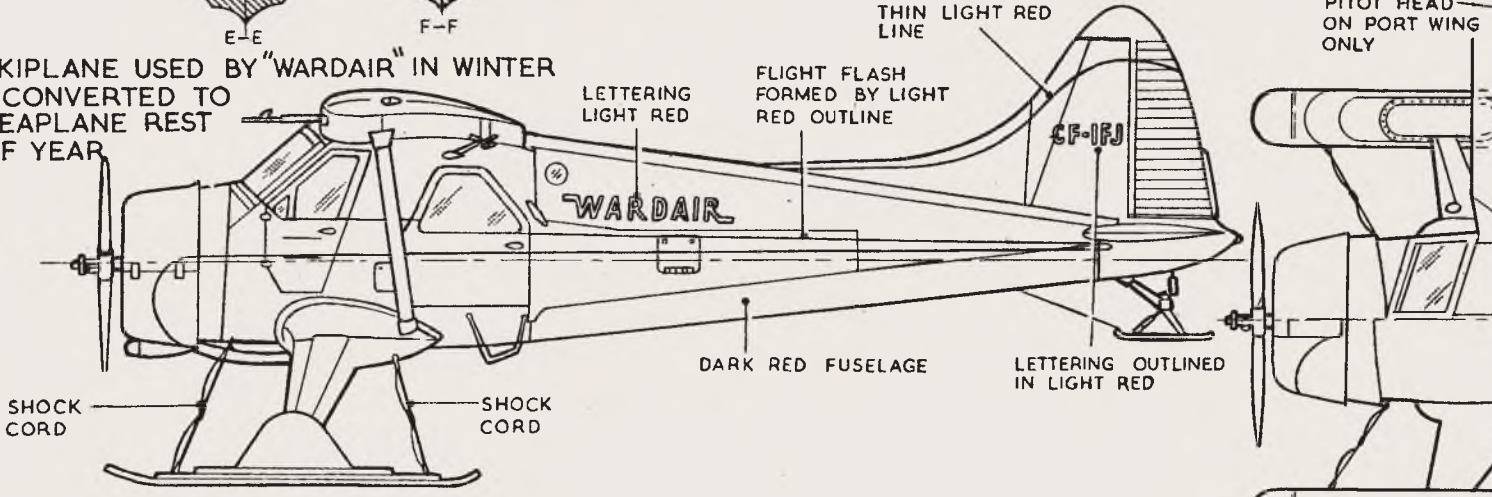

De HAVILLAND CANADA DHC-2 BEAVER

STARBOARD NAVIGATION LIGHT—GREEN

WINGS YELLOW WITH DARK BLUE LETTERING—SAME LETTERS AS ON RUDDER

ON ALL AIRCRAFT WING LETTERING IS ON TOP STARBOARD AND BOTTOM PORT SURFACES ONLY—TOPS OF LETTERS FORWARD

RED LETTERING

WINGS WHITE WITH LEADING EDGE FLASH—SEE LEADING EDGE.

MOORING CLEAT

FLOAT RUDDER MOVEMENT 27°30' APPROX. IN EACH DIRECTION

BANK OF 3 PULLEY WHEELS FOR FLOAT RUDDER ACTUATING CABLES

RED RED LINE

THE RIVETING SHOWN ON THE SEAPLANE IS ALSO APPLICABLE TO LANDPLANE AND SKIPLANE VERSIONS.

H-H

EXTERNAL STIFFENERS ON UNDERSIDE OF FLAPS AND AILERONS ONLY

THIN LIGHT RED FLASH LINE

TAILPLANE AND ELEVATORS DARK RED

PORT NAVIGATION LIGHT—RED

THE THREE AIRCRAFT PORTRAYED ON THIS DRAWING ARE AUTHENTIC IN DETAIL HENCE THE DIFFERENCE IN TRIM TABS AND THE FITTING OF BOSSES ON PROPELLERS ETC

EXTERNAL STIFFENERS ON BOTH TOP AND UNDERSIDE OF ELEVATORS

TAIL NAVIGATION LIGHT—WHITE

TAILPLANE AND ELEVATORS GREY

WINGS DARK RED WITH LIGHT RED FLASH LINE ON LEADING EDGE AND LIGHT RED OUTLINE TO THE LETTERING

SCALE 1:60

De Havilland Canada DHC-2 BEAVER

**A true
workhorse-of-
the-air and one
that might even
go on to score a
century in
service!**

Originally delivered to the US Army in July 1956 as 55-3489 this Beaver later became S-5 with the Royal Netherlands Air Force's 334 Transport Squadron at Koninklijke Luchtmacht and was finally withdrawn from use at Gilze-Rijen in September 1974. It subsequently flew in the USA and later with the Fuerza Aerea del Paraguay before finally being lost in a crash in 1979.

Progress in the field of Aviation is generally, and inexorably, an ever present on-wards-and-upwards process, so most types that come along have a limited useful life, their service longevity much dependant on the intensity of the competitive nature of the particular field of aviation for which they have been designed. But there are certain aircraft that buck the trend, some due to circumstances not necessarily envisaged, while others, introduced for much more humble yet vital 'niche' tasks, survive in service because nothing has come along that does it better and/or more economically.

One outstanding example, universally cited, is the Douglass DC-3, introduced in 1935, yet still doing sterling service of less glamorous nature than that for which it was first intended, into the 1960s - that's 45 years!

Much in the same league, the De Havilland Canada DHC-2, first flown in 1947 is still doing equally stalwart service today - nearly seventy years since its inception!

De Havilland Canada was established by the parent British Company as long ago as 1928, to build DH 60 Moth trainers, then moving on to produce DH 82 Tiger Moths for the British Commonwealth Air Training Scheme during the WW2 period, when the Canadian subsidiary also build De Havilland Mosquitoes.

With the end of hostilities in 1945 and the inevitable wind-down of wartime aircraft production, DHC was faced with the challenge of finding new products for its production capability, the first of which was the DHC-1 Chipmunk primary trainer, first flown in 1946 and which went on to become the standard ab-initial training aircraft for the Royal Canadian Air Force, and in far greater numbers, also with

“ The De Havilland Canada DHC-2, first flown in 1947 is still doing equally stalwart service today - nearly seventy years since its inception! ”





G-AMVU, the second Beaver 1 to appear on the British civil register, was originally CF-GCR and arrived in 1952 as a demonstrator. It is seen here at Rayak, Lebanon presumably demonstrating its hot-and-high performance. During September 1954 G-AMVU bore the RAF serial XH455 and two years later was sold to Sierra Leone to become VR-LAV.

the Royal Air Force. Indeed, the Chipmunk also went on to achieve its own record of service longevity.

Since peacetime military requirements were unlikely to sustain the company, de Havilland Canada turned to the civilian market to fill the void and turned instead to the civil aviation requirements of its own country with its ultra sparsely populated hinterland. They engaged the services of a famous bush pilot as Director of Sales, who began an extensive program of collecting the views of other pilots, to understand what they needed in a new aircraft - a bush plane capable of routinely operating in remote areas with the absolute minimum of ground support and with the bare minimum of landing and take-off facilities

Almost without exception, the pilots asked for an aircraft with far greater power and short take-off and landing (STOL) performance, in a design that could be easily fitted with wheels, skis or floats. When de Havilland engineers noted that this would result in poor cruise performance, one pilot replied: "...you only have to be faster than a dog sled ...".

Other suggestions were seemingly mundane but important in the bush plane world; full-sized doors were installed on both sides of the aircraft so it could be easily loaded no matter which side of a dock it tied up on. The doors were also made wide enough to allow for a 45 Imperial gallon drum to be rolled up into the aircraft.

Given this outline requirement, in September 1946, de Havilland put

together a team to design the new aircraft which was to be all-metal, unlike older designs like the famous Noorduyn Norseman which had previously served the purpose. At the time, de Havilland Canada was still a British-owned company and there were plans to fit the evolving design with the British Alvis Leonides radial engine. This unit offered limited power, so the wing area was greatly increased in order to maintain STOL performance, but when Pratt & Whitney Canada offered to supply war-surplus 450 hp (340 kW) Wasp Jr engines at a low price, the aircraft ended up with extra power as well as the projected long wing. The result was first class STOL performance for an aircraft of

its size.

The prototype Beaver first flew in August 1947 and the first production aircraft was delivered to the Ontario Department of Lands and Forests, a design partner, in April 1948.

Initial sales were slow, perhaps two or three a month, but a key intervention in



Beaver XP823 was delivered to the Army Air Corps in September 1961 and after being declared surplus in May 1987 returned to Canada and was registered C-GIYV. After passing through several ownerships, it was flying with Tyax Air Service Ltd in British Columbia as a floatplane when, in July 2004 while landing on a lake, a float dug in. The Beaver capsized and sank, fortunately without injury to the three occupants



ABOVE & BELOW: These two views of the Beaver 2 G-ANAR, formerly CF-GQE, show it being put through its paces in 1953. Fitted with the more powerful 550 hp Alvis Leonides 502/4 engine the Mk 2 also featured main planes of slightly increased length and revised tail surfaces, including deletion of the curved fillet forward of the fin. G-ANAR was temporarily serialled XH463 and evaluated by the RAF in 1954. Four years later it was trialled by the Army as XN142 before returning to Canada to become CF-CNR.



Beaver XP805 was delivered to the Army Air Corps in January 1961 and flew with various units based at Old Sarum and Netheravon, including 667 Squadron. Whilst based at the British Army Training Unit Suffield (BATUS) in Alberta, Canada, XP805 crashed near Banff, Alberta in June 1979 after hitting trees in turbulent weather. Two of the four occupants were seriously injured.

the Beaver's history occurred the following year, when the US Army started looking for a new utility aircraft. The competition quickly boiled down to the Beaver and the Cessna 195, but the Beaver outperformed the '195 and with the outbreak of the Korean War, led to orders for hundreds of aircraft. Orders soon followed from many parts of the world and continued, uninterrupted until 1967, by which time 1,657 DHC-2 Beavers had been built.

Hundreds of Beavers are still flying, many of them heavily modified to adapt to changes in technology and needs. Kenmore Air in Washington State, USA provides Beaver and DHC-3 Otter airframes with zero hour fatigue-life ratings and owns dozens of supplemental type certificates (STCs) for aircraft modifications. These revisions are so well known and desirable in the aviation community that rebuilt Beavers are often called 'Kenmore Beavers' or listed as having 'Kenmore modifications' installed.

The original Wasp Jr. radial engine of the Beaver is long since out of production, so repaired parts are now more difficult to find. Some aircraft conversion organisations have addressed this problem by replacing the piston engine with a turboprop engine such as the Pratt & Whitney Canada PT6. The added power and lighter installed weight, together with greater availability of

SPECIFICATION

Wing span: 48 ft. (14.63 m.)
Length: 30 ft. 3 in. (9.22 m.)
Height: 9 ft. (2.74 m.)
Wing area: 250 sq. ft. (23.23 sq.m.)
Max. speed: 163 mph (261 kph)
Cruise speed: 143 mph (229 kph)
Climb rate: 1020 ft/ min. (311 m/min)
Service ceiling: 18,000 ft/ 5,486m.
Take-off run: 560 ft. / 171m.
Landing run: 610 ft. / 186m.

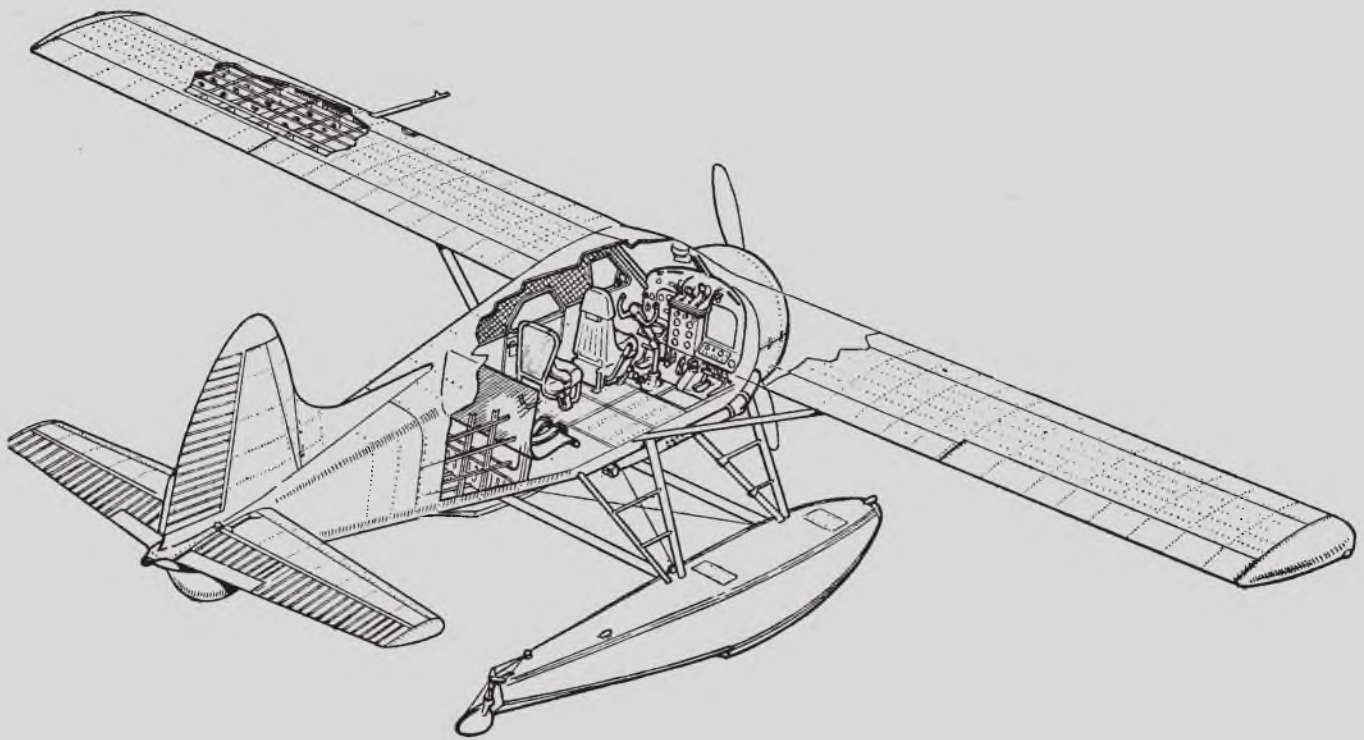

kerosene fuel instead of high-octane aviation petroleum, make this a desirable modification, but at a high financial cost. Another powerplant substitute has been the Polish 600 hp PZL radial.

Beavers have operated with the military services of no less than 33 nations worldwide, where its capabilities in rugged and remote areas of the world gave the

type its own very special niche. Its short-takeoff-and-landing capability (STOL) make it ideal for areas normally only accessible by canoe or on foot. Because it often flies to remote locations, often in cold climates, its oil reservoir filler is located in the cockpit, so that oil can be filled in flight and a series of upgrades to the basic design were incorporated.

In 1987, the *Canadian Engineering Centennial Board* named the DHC-2 one of the top ten Canadian engineering achievements of the 20th century. This is a fine accolade indeed, but perhaps the greater one is the day-in, day-out service that the type continues to provide more than six decades after it was first introduced. ■



LMA GAYDON 2015

ALEX WHITTAKER MAKES HIS FIRST VISIT TO THE GAYDON INDOOR EXHIBITION AND LIKES IT!

When the LMA called time on their Haigh Hall Spring Scale Symposium, a light went out of my life. It had always heralded the beginning of the flying season, and the end of the winter building season. They then had another good idea: an indoor meeting at the other end of the season, just before we all migrate back to our sheds and building rooms. It now holds this

indoor exhibition at the Heritage Motor Centre at Gaydon, Warwickshire. This is LMA Gaydon's fourth year of operation, and my first visit there. I must say I was very impressed.

New venue, new ideas

Essentially a purpose-built car museum, Gaydon, close to Stratford-on-Avon, is a very attractive venue. It enjoys excellent road communications, acres of free

parking, and very acceptable catering facilities. Of course, the double whammy is being able to see all the classic cars that your dad owned under one roof too! The cars are mostly on the ground floor, and the LMA panjandrum rests on the top floors.

The first stand I noticed when I went upstairs was Pete Iliffe and Ron Johnson's stunning display of small R/C scale models. Aye, the *Little Model Association*



The Heritage Motor Centre (Gaydon Museum) provides a very pleasant indoor exhibition space.



Mike Booth's latest scale masterpiece: Yakovlev YAK3, 1:3.2 scale. 3W 150cc power. Proper photos soon!



Little Model Association! Peter Illiffe's almost completed Me 262. More details soon.



Outstanding scratch-built 1/3rd scale / 98" span Bristol Scout Type D by Andy Craddock. 3W 75 petrol power.



Fine 108" span Meister Zero, fitted with a Moki 150cc radial. Built by David Brown, with scale detailing by Dave Clarke.

within the Large Model Association! Peanut Maestro Illiffe's new unfinished Me 262 airframe was just exquisite, and Ron Johnson's superb Armstrong Whitworth Whitley bomber was coming along nicely.

Focke Wulf 58C Weihe

Readers of this erudite periodical will be aware of the anonymous scale builder who is 'Spartacus'. This shadowy fella, renowned for the quality of his work and the breadth of his ambition, was exhibiting his new and massive 168" span twin engined Focke Wulf 58c Weihe ('Harrier'). She was presented for examination in-the-wood, with some covering. However, it was instantly clear that this new addition was well up to Spartacus's exacting standards.

Weihe's are very rare on the UK scale scene. The Weihe first flew in 1935. It was conceived as an armed multi-purpose Luftwaffe aircraft to cover training, communications, reconnaissance, air-ambulance, and weather research duties. It was also intended as an airliner and a VIP transport. I suppose its closest English counterpart would be the Avro Anson or the Airspeed Oxford. When Spartacus has ceased his labours on the Fw 58C, FSM will bring you a full photo report.

Klemm 25

Ghost Squadron's John Greenfield exhibited his majestic 6.5 metre (2,560") span Klemm 25. John builds ultra large

and this one is built to half full size, which seems to be his favourite scale these days. The Kelm features amazingly life-like pilot figures, and is powered by a Valach 420cc radial. I managed to get a full set of flying and static photos earlier in the summer, which will appear in FSM in due course.

In the meanwhile, you can see that this is a truly impressive airframe, very crisply modelled. I can only guess at the effort required to match all that clear-varnished wood. It must have been an epic task. Incidentally, the astounding Valach powerplant makes a stunning noise in the air.

Bristol Scout

Andy Craddock was exhibiting his outstanding Bristol Scout Type D. Scratch-built to 1/3rd scale and spanning 98", even though uncovered, this model had tremendous presence. In fact I returned to continue my study of this fine airframe three or four times during the day. She is powered by 3W 75cc petrol engine. I will definitely track her down for you next season.

DH 108 Swallow

The last time I photographed a gas-turbine powered DH Swallow was many moons ago, at The BMFA Nats. Therefore it was a delight to see this part-completed model. It transpires that this example was of historic significance too. She was designed and started by the illustrious

Peter Nye, and is now owned by Dick Spreadbury. She is built to 1:5.5 scale and has an AMT Mercury HP gas turbine power. I will endeavour to get you some flying shots of this British Jet Age classic when she takes to the air.

Folland Gnat

If you have ever seen the Folland Gnat parked out at RAF Scampton, you will know that she is a small but perfectly formed jet aircraft. To my eyes the Gnat really is a finely harmonised shape, and much more slender than the later B.Ae. Hawk that replaced it as the RAF's advanced trainer. Anyway, here at Gaydon, a brand new, fully-formed, world-class Folland kit was on show. In truth this new UK kit took me utterly by surprise. I had no idea that *Scale Composites* were about to unveil their astoundingly detailed Folland at Gaydon 2015. Set over to a lovely bank angle, the prototype kit looked superb. A really fine model with many clever technical features. I hope to get some flying shots and full details next season. Meanwhile here is the contact email: scale-composites@hotmail.com.

North American F-100D

Scale maestro Mike Booth drew my attention to an amazing 1/7th scale BVM kit F-100D Super Sabre in one of the exhibition halls. It is a fully composite model and weighs 37lbs. She has fully working slats, operative landing drag-

Famed Spartacus's latest Magnum Opus, a stunning Focke Wulf 58C Weihe. 168" span.



1/10th scale / 16'2" span Blackburn Beverley, Built by the late Malcolm Douglas Porter to his own plan.

'chute, and lights. The model airframe was originally built by Geoff White (who once tutored me on the prestigious Paul Heckles Jet Course).

This immaculately prepared F-100D was then completed by Ian Bailey. It is a

revelation. The scale patina Ian has achieved is superb. Ian used an adhesive aluminium foil called *Flite Metal*, and vast amounts of modeller's nous to get that exemplary finish. She is due to fly in Spring 2016.

DH Mosquito

Brian Hutchinson's 1/4 scale DH Mosquito stopped the show at Cosford 2015. Piloted by Steve Holland, she flew with great authority. Most of us thought she looked 'just right' in the air. She is built to 1/4 scale



Pilot Detail on Steve Vodrey's 1/5th scale Douglas Dauntless.



186 cc petrol engine, with 2:1 reduction drive destined for David Brown's 1/3rd scale Spitfire from Rob Elliss kit.



Ghost Squadron (John Greenfield design) Oriik glider built by Darren Maple. 7.5 metre span, weighs 29 kg.



Nifty small lipo-powered compressor. Less than fifty quid from Kingfisher Aviation.



Jet Central Bee II KS gas turbine on the www.turbinesolutions.co.uk stand. 7 kgs of thrust, weighs less than two pounds!



Fancy an amazing scaled-down version of yourself in your cockpit? Try: www.realmodelpilots.co.uk



Scale maestro Mike Booth drew my attention to this amazing 1/71th scale NA F-100D. Built by Geoff White and finished by Ian Bailey.



Harold Dowbekin's new North American T-28 Trojan. 1:3.6 scale / 12 foot span.



Ken Sheppard's clever 100" span Savoia Marchetti S.79, started life as a dissimilar ARTF.



Look and weep ye mere mortals. Stunning finish achieved by Ian Bailey using Flite Metal, and lots of ye black arts.



Evolution 260cc four stroke power in Harold Dowbekin's new North American T-28 Trojan.

from Brian's own blow-up of the celebrated Brian Taylor plan. She spans 13'6", and is fitted with two ZDZ 100cc inline twin petrol engines, driving Menz 27x10 props. A great stand-off-scale airframe.

Orlik Glider

When I spotted her in the display area, Darren Maple's massive Orlik glider demanded immediate attention. Built to John Greenfield's plan, she spans an expansive 7.5 metres and weighs 29 kg. It

is a little known fact of aviation trivia that an Orlik held once the altitude record for a glider. At 29,528 feet, that was a bit higher than Mount Everest. It is a classic Polish design.

Wickedly, the Gestapo murdered its designer, Antoni Kocjan, in the 1944 Warsaw Uprising. I would love to see this Orlik flying from The Great Orme.

Fokker D.VII

The word on the street all season was that Nigel Wagstaff was hatching a stunning

new scale project. (Nigel is also known as the proprietor of *Flightline Graphics*, used by many UK scale modellers). Whispered reports hinted at a really impressive WWI model. Well, at Gaydon, Nigel let the cat out of the bag. He unveiled his new Fokker D.VII, and we all stood back and admired. She is built to 1/3rd scale, using the celebrated *Glenn Torrance* plan, from the USA and is powered by a Zenoch 62 petrol engine. This drives with a Schlundt 2.5:1 geared reduction unit which, in turn, swings a Schlundt 34"x20" prop.

Paul Bellinger's 1/6th scale model of the Fokker F.70 narrow body twin jet liner. 16'11" span, 2xPST 1300r turbines.





New from Scale Composites, their stunning 1:3.5 scale Folland Gnat, in the Yellowjacks scheme.



Amazing moulded-in surface detailing on the Scale Composites Folland Gnat kit.

Not quite finished, the D.VII should fly in Spring 2016. She spans 117", and her projected AWW is expected to be in the 26-27 kgs. range. She is mostly covered in a 'full-size' material called *Diatex*, using Diatex1500 on the fuselage and the lighter Diatex 1000 on the tail.

However, the wing is covered in GTM 4 lozenge pattern, which provides a very convincing effect. The model uses a number of 3-D printed parts. For example, Nigel drew and then 3-D printed out the radiator in nylon. The impressive graphics on the fuselage feature characters from a fairy tale by the Brothers Grimm. Note that there are subtly different graphics on either side. When she is airworthy, FSM will revisit this hugely impressive model.

Trade presence

The LMA had set aside a whole hall and other spaces for a very comprehensive range of traders. I was especially heartened to see so many of the smaller specialist businesses touting their very desirable scale wares. These traders are keen modellers and their output reflects their commitment to our hobby. For instance, Phil Clark's *Fighteraces*, as well as offering a comprehensive range of kits and engines, also continue to expand its range of scale goodies. Their heavy-duty servos servo arms, resin cast exhaust stubs, scale ordnance (bombs!) and heavy duty pushrods, are ideal for the keen scaler and/or warbird.

I must admit I lusted after the VM 120 12-4T in-line petrol twin that Phil now imports from Toni Clark Practical Scale Germany (no relation).

Walking on, I noticed that Kingfisher



John Greenfield's 6.5 metre span Klemm 25. Built to 1/2 scale, and powered by a Valach 420cc radial.



Lifelike pilot in the Klemm 25. Touch of John, there?



1/3rd scale, Zenoah 62-powered Bucker Jungmeister to the MAN/ Gary Allen design.



Part completed 11'10" span DH84 Dragon, by John Rickett. Twin laser 150s.

1:5.5 scale DH 108 Swallow, designed by Peter Nye, now owned by Dick Spreadbury. AMT Mercury HP gas turbine power.



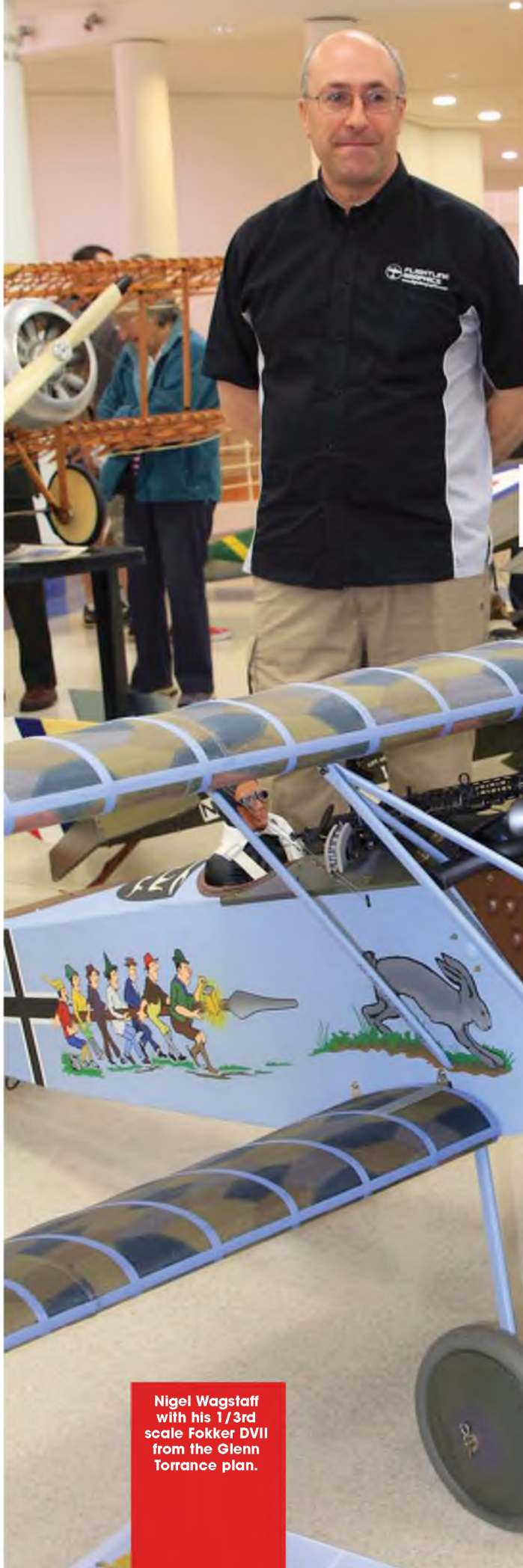

Engine detail on Nigel Wagstaff's astounding 1/3rd scale Fokker DVII.



As you might expect from the Proprietor of Flightline Graphics, the decals on Nigel Wagstaff's Fokker DVII are excellent.



Nigel has used extensive 3D printing on his 1/3rd scale Fokker DVII.



For many of us, the Star of The Show, Nigel Wagstaff's immaculate 1/3rd scale Fokker DVII.

Nigel Wagstaff with his 1/3rd scale Fokker DVII from the Glenn Torrance plan.





Richie Robinson's immaculate 28% scale Britten-Norman BN2B-20 Islander. 14 feet in span, weighs 88 lbs, 2 x 3W 60cc petrol power.



On view at Gaydon, Brian Hutchinson's 1/4 scale DH Mosquito stopped the show at Cosford. 13'6" span, 2 x ZDZ 100cc inline twin petrol engines.



Nigel l'Anson's very appealing Nick Zirol Helcat, in a rare Experimental Drone scheme. Evo 80 petrol power, 106" span.



New Willis Warbirds Yak 50 scale kit.

Aviation had an intriguingly small li-po powered compressor for less than fifty quid. This was complete with lipo. I like gas turbine power as an observer, and I was also impressed by the Jet Central Bee II KS gas turbine on the www.turbinesolutions.co.uk stand. This produces 7 kgs of thrust, and weighs less than 0.8 kgs (two pounds in real world measurements) complete with starter. Needless to say, with the shed season beckoning, the trade area was booming all day.

The Verdict

LMA Gaydon gets Five Stars, all of them Gold. A great day out for all the family, as well as the scale aficionado, Gaydon is a bumper exhibition. The quality and range of the models was impressive. Also, seeing part-built airframes always brings deep joy to the heart of any true aeromodeller. We also had a glimpse into the future, with a sneak preview those models which should be flying next year on the LMA circuit. In addition, I thought that LMA 'Tony Hooper's idea of inviting some top-

flight Peanut Scale modellers, like the illustrious Peter Iliffe and Ron Johnson, to display their airframes was inspired. The overall Trade Presence was large and busy all day, and I bought everything from glues and resins to wood and servos. Finally, the additional bonus for me was being able to buy my favourite Southern Modelcraft fuel directly from the stall in the car park! ■



Heavy Duty Pushrods for Fighteraces.



Dummy exhaust stubs are often difficult to get right: Fighteraces cast resin exhausts to the rescue.

From time to time, most of us fancy adding some ordnance to our warbirds. These Fighteraces items looked explosive.

NEW FROM ADH PUBLISHING

The Modeller's Guide

Superdetailing, Painting and Weathering

Aircraft of WWII, with airfield accessories, ordnance and diorama

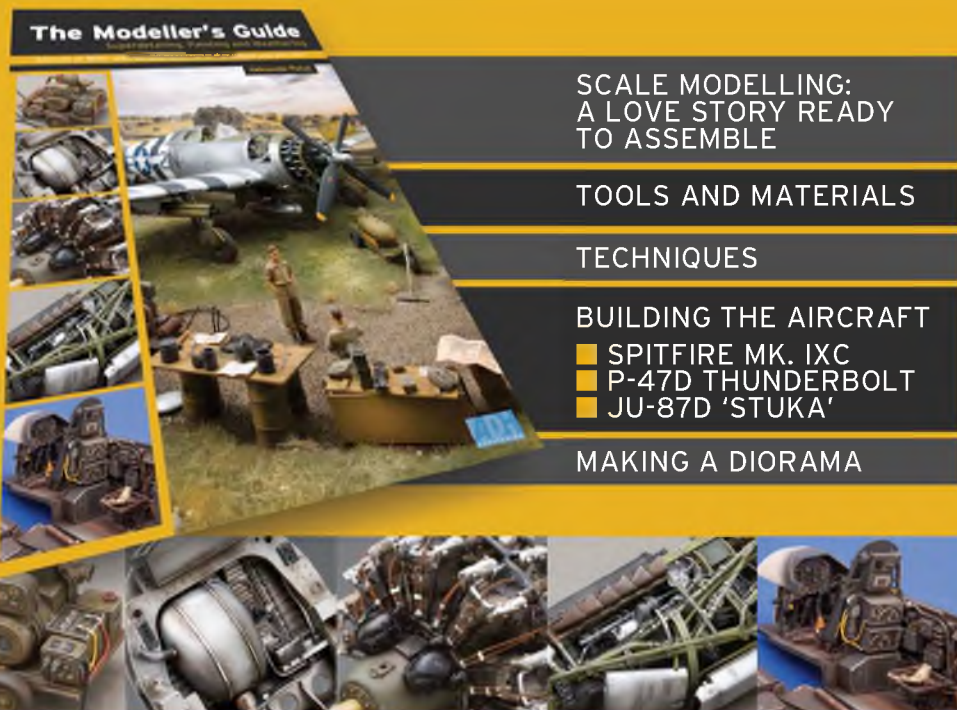

Aleksandar Počuĉ

Modeller's guide to superdetailing, painting and weathering aircraft of WWII' book is intended for both beginners and advanced modellers as it covers wide variety of modelling tasks ranging from basic detailing, scratch-building, painting, weathering, machining custom parts using resin as well as scratch-building part from brass and aluminium and of course, diorama making. Basics about tools, paints and modelling materials have been covered as well. The book revolves around three subjects, P-47D Razorback, Spitfire Mk.IXc and Junkers Ju-87D Stuka, all in 32nd scale. Step by step concept will provide a good reference and ideas to all WWII aircraft modellers regardless of their experience.

ORDER NOW:



www.adhpublishing.com



01525 222573



enquiries@adhpublishing.com

FOR ONLY

£18.95

PLUS P&P



ADH PUBLISHING, Doolittle Mill, Doolittle Lane, Iotternhoe, Bedfordshire, LU6 1QX, United Kingdom.
TEL: +44(0)1525 222573. FAX: +44(0)1525 222574. ONLINE: www.adhbooks.com

The end-result of the author's experiments with contra-rotating propeller units was his West Wings Supermarine Spitfire Mk.22, the full size of which had contra-props. The 'navallised' equivalent for the Royal Navy's Fleets Air Arm, the Seafire Mk.47 was so equipped too.



SMALL TORQUE

THE LATE JOHN RALPH CONDUCTED THESE SUCCESSFUL EXPERIMENTS WITH CONTRA-ROTATING PROPELLER SYSTEMS FOR SMALL AND ELECTRIC AND RUBBER POWERED FREE FLIGHT MODELS

The main attraction of contra rotating propeller systems (CRPs), apart from adding that special touch to the look of a scale model, is the potential lack of torque reaction. This should help in trimming any model, but in particular, will considerably aid in the trimming of low wing free flighters. Indeed, it was my experience with my electric powered Miles Kestrel (*AeroModeller* July '96), which led me to experiment with CRPs. I am sure my findings of needing an awesome amount of right side thrust to

balance the torque of a near-scale, highly pitched propeller will be familiar to anyone who has flown such a model.

KEEP IT SIMPLE

The reluctance to use a contra-prop of course, is the perceived complexity of making it and the vulnerability to damage, so such units are rarely seen, even on scale models that call for them. The only one I have seen was on Dave Chinnery's electric powered Bristol Brabazon and a magnificent sight the props and the model were.

However, the units used by Dave were specially engineered and somewhat beyond your average modeller to make. What I wanted, was something that could be made up without much trouble, hopefully using readily available bits.

I considered several approaches until, one day, while playing with a couple of *Knight & Pridham* (K&P) geared electric motors, it dawned on me that one answer was staring me in the face! An internal gear from a *Knight & Pridham* KP-01 motor, driven by its matching pinion at one end of a motor

shaft, with a concentric spur gear from the KP-01, driven by its matching pinion at the other end: simple and fairly compact!

TO THE WORKSHOP

I quickly made up this Mk. 1 system (**photo 1**) using a KP-02 motor, which has just about enough shaft length on the 'spare' end to fit a KP-01 pinion. The driven shaft needed to run very slightly out of parallel to the motor shaft, because of a 1mm difference in gear centres. This could have been avoided by changing the KP-02 pinion for a KP-01, but I did not realise that at the time!

The unit was fitted with 4" wooden props, with a 4" pitch, on a 4:1 geared front shaft and a 4" pitch on the 5:1 gear. The setup ran convincingly on a couple of nicads, giving about 45g. thrust, but more importantly, it produced hardly any torque reaction. When hung on my simple thrust rig (a 30cm piece of 16g. wire!) with a rubber band, the latter barely twisted. This was of course due to a fortunate choice of propeller pitches, as I was to discover later.

Although this Mk. 1 unit was fun to play with, it was a bit heavy at 50g. for the model I had my thoughts on. It was also a bit 'current greedy', only running for about 25 secs. on a pair of 50mAh cells. So what next?

EVEN SIMPLER

Among my small electric motors, I had a so-called 'E30' KP-01, on which the eight-tooth pinion drives a 50-tooth internal gear almost identical to that used on the KP-02. This gives a high gear ratio of 6.25:1, compared to the

standard 4:1 and is aimed at giving contest enthusiasts what a lot of them think they need to win!

However, I had other ideas of how to use the set-up. Why not re-fit a normal 32-tooth spur gear back on the drive shaft behind the 50T internal gear? The latter would be drilled out to run freely in the same shaft as the spur, but of course, in the opposite direction. The proposed layout is shown in Fig 1a and as can be seen, is very compact.

GETTING THE BITS

Not wanting to pillage more gears off my existing standard units, I obtained a batch of K&P gears and while I was at it, a couple more motors and a selection of their neat plastic pusher and tractor props for my experiments. Support 'home' industries I say!

The bits arrived next day and I lost no time in putting my Mk.2 idea into practice. The 50-tooth grey KP-02 and orange KP-01 internal gears are very similar and either may be used for the rear prop. The latter's blades are mounted in a balsa disc which is glued onto the front of the journal bearing removed first (**photo 2**). The rear should also be drilled through to allow it to run freely on the contra-rotating shaft.

STAY LOOSE

Having carried out the simple modifications on a couple of units and assembled them (**photo 3**), I did find the gear meshing a bit variable. Some tight spots were evident, particularly on the orange gears. I managed to free things up by a bit of careful scraping

of the gear teeth tips with a sharp scalpel. A slack mesh is much to be preferred to a tight one.

K & P subsequently made some adjustments to the plastic mix to avoid post-casting distortion, so that the gears thus run smoothly without 'tweaking'.

As can be seen from the cross section drawing, two PTFE thrust washers were inserted in the drive train, one between the KP-01 switch cam and the front of the motor frame. This takes the thrust of both props while the second, between the 50T gear and the back of the front prop disc, takes the rear prop thrust. The front prop disc was made from 1/32" ply, glued to 3/8" balsa, intended to take the blades.

SIX BLADES ON MY WAGON

Yes folks, three blades now for both prop. assemblies, because this unit, I could see, was small and light enough (18g) to fit into the *West Wings* Spitfire Mk.22. I decided to use K&P prop blades from their 7" diameter set and mount these in balsa discs as mentioned above. The latter were drilled out carefully at 120 degrees to take the blade roots as a tight push-fit. I went the whole hog while I was at it and used the spinner from the kit to complete the job. When fully assembled, this little unit looked great (**photo 4**) and spun away merrily on three cells, producing a good 'breeze'.

Once again, after a bit of pitch adjustment (front 7"/rear 11"), lack of torque reaction was clearly observed.

However, the little KP-01, although turning

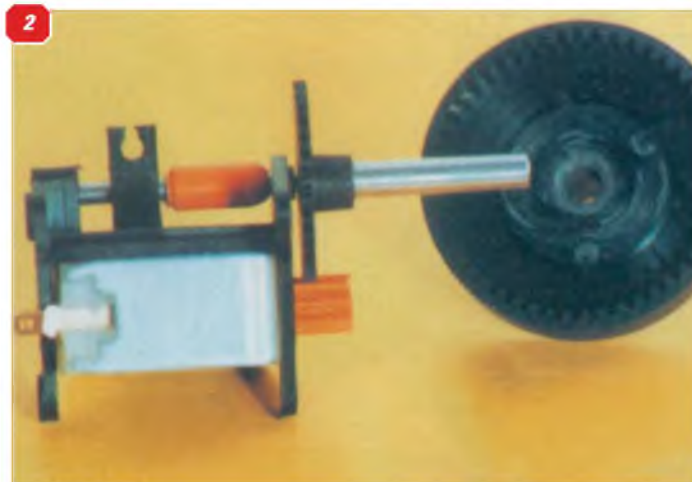
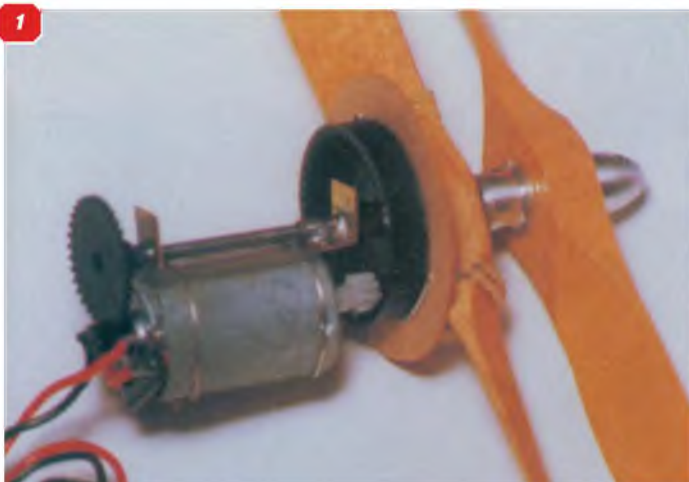

1: The original Mk.1 unit. 2: Mk.2 CRP system with modified KP-01 and KP-02 gears ready for assembly. 3: The Mk.2 unit in fully assembled state. 4: The Mk.2 unit with six prop blades and spinner in place.



5: Mk.2 unit, showing the fuselage nose of the West Wings Spitfire Mk.22 into which it plugs. 6: Detail of the battery, mounted in the rear wing bay. Note the charging socket and on/off switch. 7: Mk.3 CRP unit, using Scientext ST-2 motor. 8: Mk.3 unit extracted from the Spitfire nose.

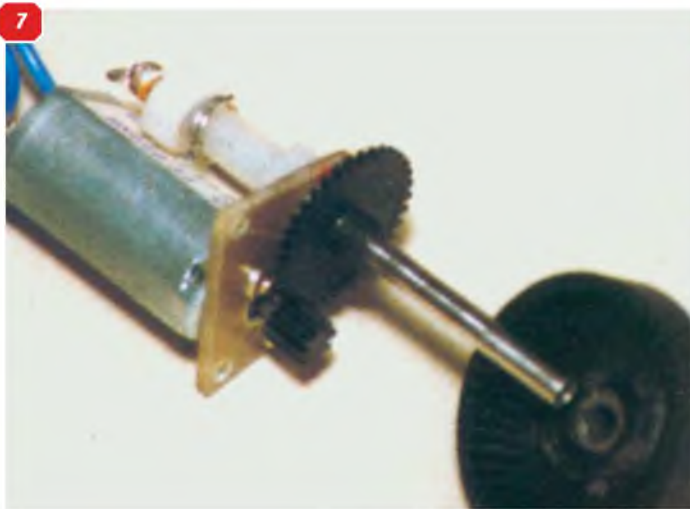

the front props at nearly 2,000 rpm was clearly operating at well beyond its intended current range. I measured a peak thrust of around 30 grams on a set of three 50mAh cells, but these were exhausted in about 35 seconds, becoming rather hot in the process. But I decided to press on anyway and build the Spitfire to see if the unit would fly it.

BUILDING, COVERING & PAINTING

I was aware, before I started building, that I should try and cater for landing knocks on the CRPs, so I opted for a rubber band retained front bulkhead. The motor was screwed to the latter, which would, I planned, flex down out of the nose, much like a rubber model's nose block (Photo 5).

I built the wings plug-in style, again to avoid hard knock damage and tidied up the wing root fairing method by adding extra stringers. I covered the wing and tailplane in tissue, over Mylar and the fuselage in 20gm/sq.m. art silk. A couple of thin coats of clear dope, followed by Humbrol Matt Camouflage paint and the kit transfers finished the job off nicely.

However the 'jewel-in-the-nose' was the contra-prop unit. Those two sets of blades looked just great. The balance point worked out nearly right and only a few grams of nose weight were needed. I had located the battery in the rear wing bay before covering (photo 6), but a better idea, in hindsight, would have been to locate the

cells in a balsa tube to permit easy balance point adjustment.

FLYING ... NEARLY!

As is often the case, I had to wait a while for suitable weather to see how the model performed. In the meantime, I occasionally enjoyed charging the batteries and just watching the blades go round! However, I was a bit concerned that the 'breeze' from the front might not cope with the completed model's all-up weight of 125g.

Come the first launch and I unfortunately found out that I was right to be concerned. A few seconds of straight (very) flight was about all the model could manage in spite of appearing to be in good trim. I tried a few different blade pitch settings, but without improvement. A small reduction in diameter to 6.5" helped a bit, but not enough to pursue that approach. Anyway, I wanted to retain the near-scale look of the propeller. The encouraging feature of the first tests was the hoped-for lack of any significant torque induced turn.

WATT NOW?

The next move was to increase the power by the simplest route of adding another battery cell. This was rather cruel to the KP-01 motor that was already driving more than three times its normal prop-count. But this change did produce more positive results, the model at least climbing - albeit not for very long. About 7-8 seconds was all it could

manage, but it did look great and again, there were no signs of troublesome torque problems.

At this stage, I reluctantly faced the fact that a more powerful motor was required to fly my not over-light model. A sort through my small motors turned up a likely one labelled FF-050H. I knew from earlier direct-drive tests on a Cox 4.1/2" prop that the motor had an excellent power-to-weight ratio and local friend, John Cooke, also confirmed that he thought the motor was very good. He had in fact used two geared ones.

John obtained his motors from Scientext in U.S.A (identified there as 'ST2'). This Mabuchi canned motor is a little longer and heavier than the KP-01, but it was easy to fix it on a bit of fibreglass board and retain the same mounting centres. (Photo 7).

That done, I swapped over all the CRP bits and the nose plug from the Mk.2 and, hey-presto, the Mk.3 unit was ready to go.

THRUST TESTS. BEWARE 'FINE' FIGURES

The new unit was very free running, thanks in part, to the smaller (than KP-01) rear shaft I used (16 swg.) and the gear mesh 'tweaking' I could do by moving the nylon bearing slightly.

First thrust checks with the same pitch settings as the Mk.2 showed a significant improvement. I recorded a peak thrust of around 55g, which dropped off relatively

slowly, being still 25g. after 50 seconds, using the original pack of three 50mAh cells.

THRUST TESTS. BEWARE 'FINE' FIGURES

The new unit was very free running, thanks in part, to the smaller (than KP-O1) rear shaft I used (16 swg.) and the gear mesh 'tweaking' I could do by moving the nylon bearing slightly.

First thrust checks with the same pitch settings as the Mk.2 showed a significant improvement. I recorded a peak thrust of around 55g, which dropped off relatively slowly, being still 25g after 50 seconds, using the original pack of three 50mAh cells.

Installation was identical to the Mk.2 (photo 8) and the few extra grams up front put the balance right without ballast. So the model was ready to go again after the usual few days wait for calm conditions.

Before the model was flying as it did thereafter, a couple of degrees of up-thrust was found necessary to compensate for the extra down-couple accompanying the increase thrust. No side thrust was used of course - that's the whole point of contra rotating propeller units, as well as being able to handle more power per unit of blade span, which is a further bonus.

However, by increasing the pitch of one or other of the dual prop assemblies, the torque reaction of the prop concerned will (within limits) increase. This will induce the model to turn unless matched by a corresponding pitch increase on the other prop. I found this quite convincingly demonstrates during trimming flights.

One important thing I learned while doing my simple static thrust tests was not to be misled by propeller pitch settings that give high readings. By reducing the blade pitches, I recorded nearly 60g. static thrust, but the pitches were too fine at the relatively slow speed of 2,200 rpm (front blades) to fly the model fast enough. Coarser pitches found to suit the model (8" and 11") only produced a static thrust of around 45g, indicating a stalled condition. No great surprise I expect, to many of you old-hands out there. I should have remembered a previous experience trying to hand-launch an FAI pylon racer with an 8" x 9" prop, but that was long ago!

RUBBER POWERED TOO!

In case a few broad-minded rubber power enthusiasts have been reading this, I will reward them by suggesting a single motor CRP unit for them! I know it's already been done and long ago, as my 1942 edition of 'Airscrews for the Aeromodeller' shows.

The caption on page 38 of an elegant elliptical winged 'streamliner' indicates, it was the combined effort of C.F. Hedges and R.V. Bently. It used a single motor to drive its two large co-axial propellers through an ingenious gearing system. No details of the latter were given though!

My proposed arrangement is very similar to my Mk.2 electric system, already described. A cross section drawing of it is shown in Fig.1b and photo 9 show the trial unit. As can be seen, the gears used are also those used for the electric drive, but now the small pinion simply acts as an idler between the 50T internal gear and the 32T spur.

The latter can be free on the drive shaft until there is sufficient rubber tension to drive it via a rubber clutch disc. This does require careful attention to the length of the front

FIG. 1A

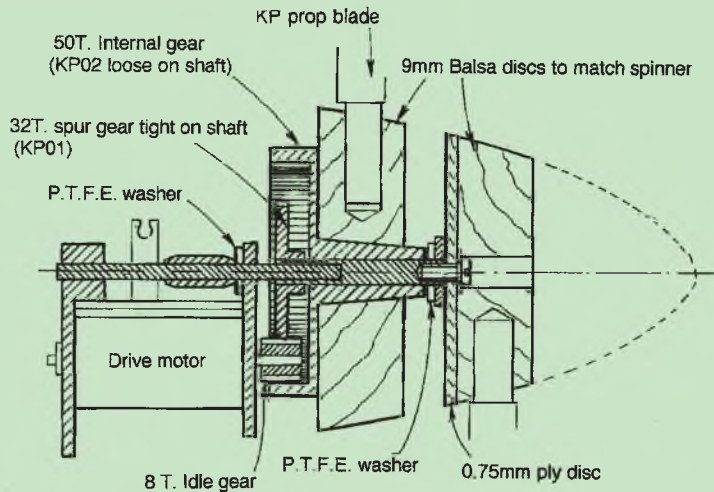

FIG. 1B

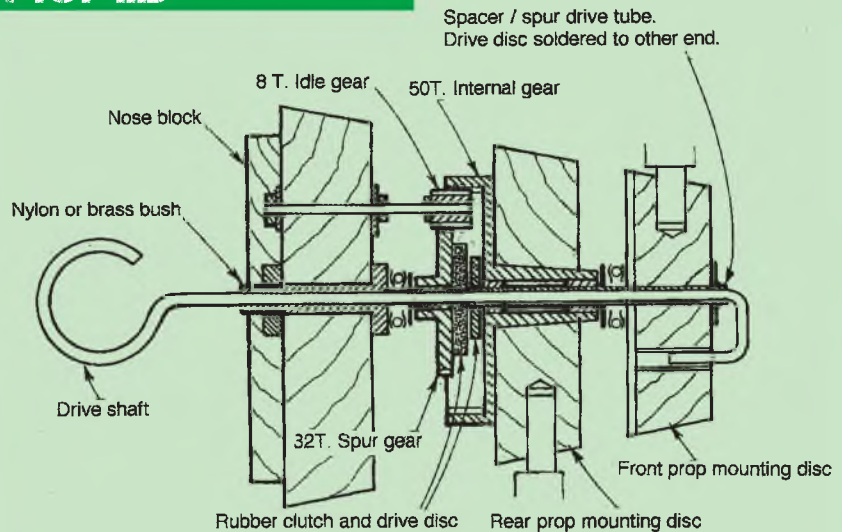
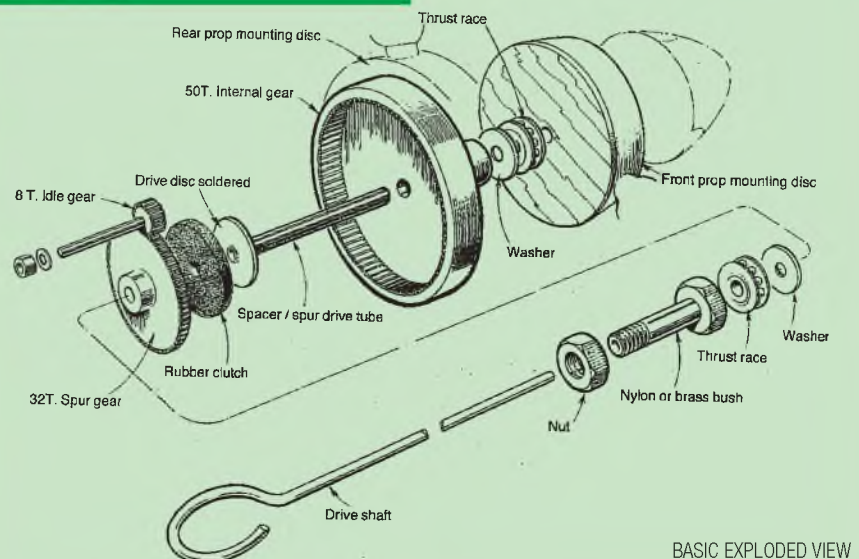
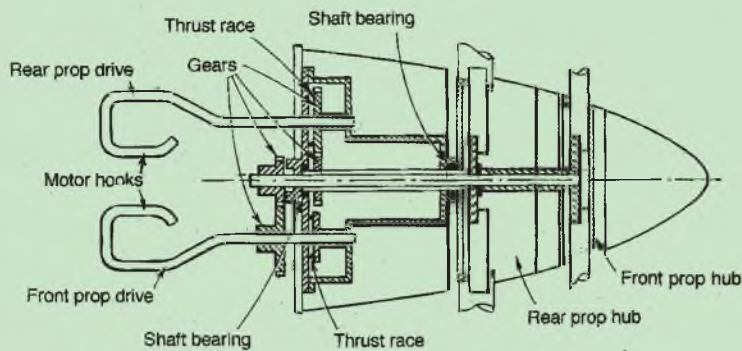

FIG. 2



BASIC EXPLODED VIEW

FIG. 3DEREK KNIGHTS SYSTEM FOR RUBBER
POWERED 'WYVERN'

spacer/drive tube, which needs slotting at the front to engage the crank to which the driven clutch plate is soldered at the rear of the drive tube. I used a piece of PC board. A couple of standard thrust races were put in to reduce friction and the main bearing could also be a normal brass type, although I often, as here, used a drilled nylon bolt.

The unit has not been used in a model, but it seems to function all right and with this set-up a bit more rubber can be added, if more power is required.

GREAT MINDS ETC!

Since none of the foregoing would

have happened without the availability of K&P parts, I decided to let *Knight & Pridham* know about my efforts early on. Their response was a parcel, from Derek Knight, with details of his own CRP unit fitted to the elegant nose of an uncovered model. Also included was a unique looking double KP-01 assembly. Derek's covering letter explained details of the unit he used in his Westland Wyvern (see Fig. 3). Though heavy at 40g, it works well, (better than the aircraft). The shaft has both ball and roller bearings, where necessary and the KP-02 prop blades

are held on by M2 screws.

Derek's double-motor arrangement is an interesting one (photos 10, 11 & 12) and in some ways is a more flexible approach. Any pair of matching gears can be used, spur as well as internal type, provided that the motors can be accompanied within the gear spacing.

The bare unit when assembled (photo 11) weighed 30g and a couple of prop combinations were tried on it. One of them, with homemade blades is shown in photo 12.

I recorded about 50g static thrust, but for reasons indicated earlier, that figure needs to be treated with caution. The unit does however, gobble up the battery rather rapidly and even when 'free-running' it takes around two amps.

This is partly to be expected, because there are two motors in parallel, but it still seems high to me. The gears are not tight and the unit turns over freely enough by hand. My initial feeling, based on further comparative tests, indicated that small internal gears are less efficient than spur gears. I believe Derek's double-motor arrangement will work better with two spur gears. The motors will need spacing a little further apart if standard KP-01 32T spurs are used.

I reckon that, between Derek and myself, we have given potential CRP users a few ideas to work on.

Anyone for an Avro Shackleton? ■

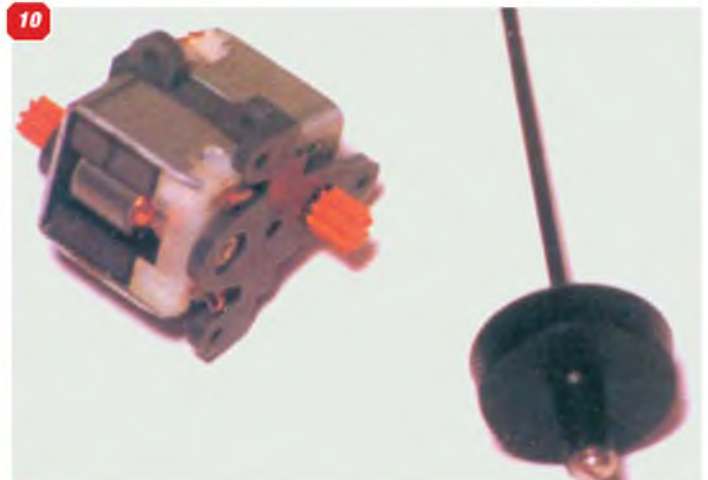
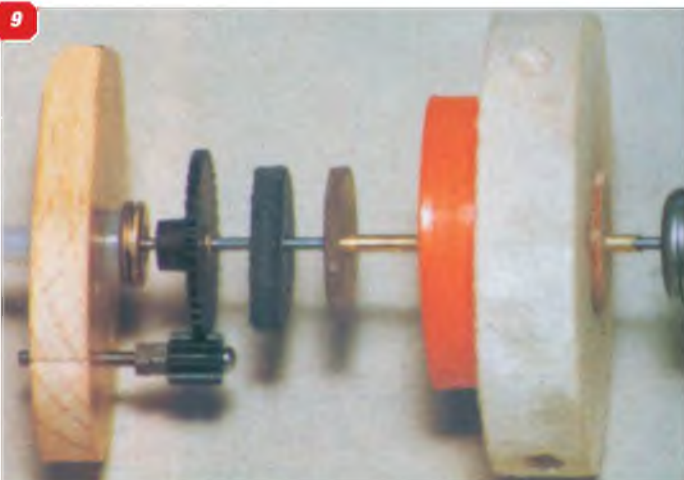

9: Contra-rotating unit set up for rubber power and shown in Fig.1b. 10: Components of Derek Knight's CRP unit for two KP-01 motors. 11: Derek Knight's twin-motor CRP assembled motor and drive mechanism. 12: Derek's completely assembled twin KP-01 unit with trial propellers mounted.

AeroDetail series

Making a scale model?

Finding the detail needed to finish a scale model can be difficult and getting full size images is not always practical. Our range of detail photo collections provides extensive close ups of a wide range of popular aircraft all on CD in J-peg format



Whitman Tailwind CD106

Two examples shown of this U.S. homebuilt lightplane, with boxy shape ideal for modellers. Complete close-up detail. (62 images)

Westland Lysander CD105

The Shuttleworth Museum's airworthy example shown in both camouflage and Special Operations black finishes. Full close-up detail. (62 images)

Waco Ymf-5 CD104

Beautiful and graceful spatted undercarriage biplane of the 1930s 'golden aviation era'. Example photographed is an accurate-in-every-detail modern replica. (130 images)

Vickers Supermarine Walrus CD103

The famous 'Shagbag' biplane seaplane, used during WW2 as an air-sea rescue craft and fleet gunnery spotter. (80 images)

Tipsy Belfair CD102

Highly attractive Belgian low wing light aircraft from the era of simple, open cockpit private flying. Machine offers scale modellers pleasant lines and simple shape. (35 images)

Thulin Tummelisa CD101

Swedish 1919-era fighter trainer that served the Swedish air arm for many years. Example depicted is a faithful reproduction. (55 images)

Supermarine Spitfire MK.XVI CD100

Last of the Merlin-engined Spitfires. This collection depicts the cut-down fuselage, bubble cockpit canopy later version. (116 images)

Supermarine Spitfire MK.IX CD99

The most numerous version of the classic Spitfire that turned the tables on the Luftwaffe's Focke Wulf Fw 190. (90 images)

Supermarine Spitfire MK XIV CD98

2nd of the Griffon-engined Spits (Mk.XII was

first), the bigger engine forced a change of the classic Spitfire shape. (58 images)

Supermarine Spitfire MK Vc CD97

Shuttleworth Museum's airworthy example presented in it's latest form with classic rounded wingtip planform. (160 plus images)

Supermarine Seafire Mk17 CD96

The Seafire 17 was no navalised Spit. A true ground-up naval fighter. (64 images)

Stinson 105 CD95

Light, private aircraft of the 1940-50s era, with lots of character. (75 images)

Steen Skybolt CD94

Attractive U.S. aerobatic biplane, presented in full detail. (89 images)

Sopwith Triplane CD93

The last example of the 'Tripehound' is the one built (in 1980!) from original Sopwith drawings by Northern Aero Works and given sequential manufacturer's number by Sir Thomas Sopwith himself in recognition of the outstanding workmanship. Extensive detail. (120 images)

Sopwith Pup CD92

The charismatic Sopwith Scout (to give its correct designation) is a great scale modellers' favourite. Example depicted is the one preserved and regularly flown at the Shuttleworth Collection, Old Warden. (50 images)

S.E.5A CD91

Shuttleworth Museum's airworthy example presented in full detail. (100 plus images)

Ryan Pt-22 CD90

US military primary trainer aircraft that served with both US Army and Navy, thus providing ab-initio flight training for the majority of US airmen of the WW2 period. A highly attractive aircraft. 90 images of the preserved, airworthy aircraft, hangared at the Shuttleworth Collection, Old Warden.

Republic P-47D CD89

Bubble-canopy version of the much loved 'Jug', photographed in fine detail. (105 images)

Polikarpov Po-2 CD88

The world's most numerous produced aircraft of all time, the P0-2 was a great maid-of-all-work used by both military and civil groups in the old Soviet Union and its satellite states. Example depicted is pristine, and now in storage at Old Warden. (170 images)

Polikarpov I-15 CD87

The ultra agile Russian biplane fighter aircraft that saw widespread service prior to and in the early years of WW2 and during the Spanish civil war. Example illustrated is a superbly restored machine. (100 images)

Pitts S.1 CD86

Homebuilt example by Bob Millinchip, as seen at 2002 PFA Rally. Complete detail study (36 images)

Piper Tomahawk CD85

Cranfield Flying School example of this civil ab-initio trainer aircraft. (54 images)

Piper Super Cub CD84

The later, 'cleaned-up' version of the famous Piper J-3, with more elegant engine cowl. Two examples shown. (80 images)

Piper L-4 Grasshopper CD83

Military version of the famous Piper J-3 Cub used during WW2 and close reconnaissance and spotter aircraft and for many other tasks. (80 images)

Percival Provost CD82

Airworthy, preserved example of the RAF piston engined basic trainer used in the 1950s. Full detail. (30 images)

Percival Mew Gull CD81

Famous 1930s racing and record setting aircraft that will forever be linked with the achievements of British aviator Alex Henshaw. (35 images)

North American T28 CD80

The advanced trainer aircraft that served in many air arms worldwide and also became a counter-insurgency ground attack aircraft. Examples illustrated are from France, where the type served for many years as the 'Fenec'. (100 plus images)

North American P51D Mustang CD79

The definitive bubble canopy Merlin Mustang. In detail, showing several restored examples. This is the Fantasy of Flight Museum's overpolished example, but the close-up detail is all there. (102 images)

North American P51B/C CD78

First of the Rolls Royce Merlin engined Mustangs, this collection depicts the Fantasy of Flight Museum's restored example, with overly polished plain metal surfaces. Much detail. (102 images) Also, 41 images of The Fighter Collection's P-51C in bare metal restoration, showing much surface and internal airframe detail. A real bumper bundle! (over 140 images)

North American B25 Mitchell CD77

Fantasy of Flight Museum's example. Photographed soon after superb restoration. Full nose to tail detail. (74 images)

North American AT6 Harvard CD76

AT-6, SNJ, Texan, Harvard - call it what you will. 55,000 were built - this example is in U.S. Army colours, with comprehensive close-up detail, nose to tail. (76 images)

North American A36 Invader CD75

The ground attack variant of the Allison engined P-51A. Photos, in detail, of the world's only airworthy example. (69 images)

Morane Saulnier MS406 CD74

French WW2 fighter that fought in the Battle of France, 1940. Swiss restored example (92 images)

ORDER FORM - Aerodetail CDs

Please send me the following CDs:

Name: _____

Address: _____

Postcode: _____

Daytime Tel No: _____

I enclose a cheque for £ _____

(Made payable to ADH Publishing)

Please debit my credit card for £ _____

(VISA / Mastercard - please delete non-applicable)

Card No: _____

Expiry date: _____

CCV: _____

SIGNATURE: _____

DATE: _____

Order on line at
www.flyingscalemodels.com or aero-modeller.com



£12.99 (including p+p)* per CD *UK only
Postage: (Europe); £2.50 (World); £3.50

Send to:

ADH Publishing Ltd,
Doolittle Mill, Doolittle Lane, Totterhoe,
Bedfordshire, LU6 1QX. Great Britain.
Tel: 01525 222573 Fax: 01525 222574
Email: enquiries@adhpublishing.com/shop
Allow 21 days for delivery

Classifieds



DB SPORT & SCALE LTD

RADIO CONTROLLED MODEL AIRCRAFT KITS AND ACCESSORIES



NEW CLICK & BUY WEBSITE WWW.DBSPORTANDSCALE.COM
TEL: +44 (0)1792 897501 EMAIL: SALES@DBSPORTANDSCALE.COM

The RC Hotel Corfu Greece

English speaking instructors. No more travelling for an hours tuition every weekend. Everything is at your doorstep.

FLYING SCHOOL

Learn to fly fixed wing and helicopter while on a holiday. Tuition from English speaking instructors. No more travelling for an hours tuition every weekend. Everything is at your doorstep. Visit our web site for more information. www.rchotel.com

Tel 00302661099322 Mob 00306932420044

Email spiro@rchotel.com or rchotel@ker.forthnet.gr

The RC Hotel, PO Box 1567, Pulades, 49083, Corfu, Greece

MANTUA MODELS UK LTD

Tel: 01753 856321 Fax: 01753 857444

179 Dedworth Road, Windsor, Berkshire, SL4 4JN

Open Mon-Sat 9.00 - 6.00pm

MANTUA AND AVIOMODELLI AIRCRAFT AND ACCESSORIES

Trade enquiries welcome for our full range of aircraft

MASTERCARD/VISA

STEVE WEBB MODELS & HOBBIES

Tel: 01928 735225

80 Church Street, Frodsham, Cheshire, WA6 6QU

Fax: 01928 735410

Mon-Sat 9.30am - 5.30pm Closed Wednesdays

MASTERCARD & VISA ACCEPTED

email: stevewebb@steve-web.demon.co.uk

Vintage Limited Edition Prints

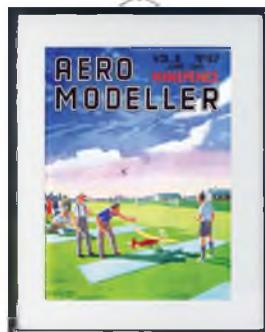

visit: www.aeromodeller.com for the full range



Vintage **AeroModeller** A3 Cover Artwork - *Limited Edition Prints*

DURAFLY[®]

"I am easily satisfied with the very best"

- Winston Churchill



SPITFIRE MK1 A

WINGSPAN: 1100MM (43.3")

FLYING WEIGHT: 1200-1250G (45-49oz)

ESC: AEROSTAR 50A BRUSHLESS ESC

MOTOR: AEROSTAR 3536 770KV OUTRUNNER

PROP: 10X5 3 BLADE SERVO: 6X 9G

Available at hobbyking.com

REALFLIGHT DRONE

Flight Simulator

No.: GPMZ4800



Master the aerial camera

InterLink® Elite Controller
recreates transmitter function

Whether you're learning to fly or an aspiring aerial photographer needing help taking photos and videos from your multirotor, the new RealFlight Drone flight simulator from Hobbico teaches you both from the safety of your PC.

Designed to help you master drone and camera control at no risk to your flying machine or equipment, RF Drone uses exclusive RealPhysics™ technology to recreate hyper-realistic aircraft and flying sites. Both beginners and seasoned flyers can use the software to learn to:

- Develop flight agility skills using 15 different multirotor configurations
- Manoeuvre drones into the best position to capture desired shots
- Master basic camera gimbal operation to find the best angle for aerial photos
- Perfect First-Person-View (FPV) camera control by framing each scene from a 'drone's eye view'
- Practise flying and taking photos in a variety of conditions, including day, night and changing wind scenarios

www.realflight.com/drone



Master Gimbal Function



Many Challenges to Perfect



20 detailed Flying Sites



Instantly Correct Mistakes



Refine Flying Skills



Choose from 15 Exciting Drones

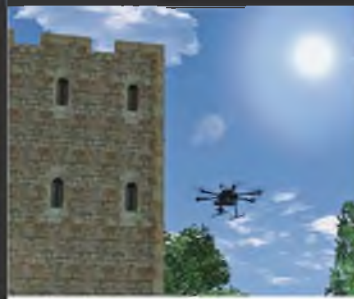

Practise in the Daytime...



...Or try Night Flight!

Master the aerial camera True to Life